

## Electrosurgery



Zubehör für die Elektrochirurgie  
Accessories for electrosurgery  
Accesorios para la electrocirugía  
Accessoires électrochirurgicaux  
Accessori per elettrochirurgia



KLS Martin Group

Zubehör für die Elektrochirurgie  
Accessories for electrosurgery  
Accesorios para la electrocirugía  
Accessoires électrochirurgicaux  
Accessori per elettrochirurgia

<p>Monopolare Elektroden-Handgriffe        Monopolar electrode handles        Mangos porta-electrodos monopolares        Manches porte-électrode monopolaires        Manici portaelettrodi monopolari</p>		<p>5-12</p>
<p>Monopolare Elektroden        Monopolar electrodes        Electrodos monopolares        Electrodes monopolaires        Elettrodi monopolari</p>		<p>13-35</p>
<p>Neutralelektroden        Neutral electrodes        Placas neutras        Electrodes neutres        Elettrodi neutri</p>		<p>37-42</p>
<p>Bipolares Instrumentarium        Bipolar instruments        Instrumentos bipolares        Instruments bipolaires        Strumenti bipolari</p>		<p>43-71</p>
<p>Instrumentarium zur bipolaren Gefäßversiegelung        Instruments for bipolar vessel sealing        Instrumentos para el sellado vascular bipolar        Instruments pour la clampage vasculaire bipolaire        Strumenti di sigillatura vascolare bipolare</p>		<p>73-89</p>
<p>Monopolare und bipolare Anschlusskabel sowie Adapter        Monopolar and bipolar connecting cables and adapters        Cables de conexión así como adaptadores monopolares y bipolares        Câbles de raccordement et adaptateurs monopolaires et bipolaires        Cavi di collegamento e adattatori monopolare e bipolare</p>		<p>91-107</p>
<p>KLS-Martin-Argon-Beamer-System (MABS)        KLS Martin Argon Beamer System (MABS)        Sistema KLS Martin Argon Beamer (MABS)        Système KLS Martin Argon Beamer (MABS)        Sistema KLS Martin Argon Beamer (MABS)</p>		<p>109-123</p>
<p>Rauchgasabsaugung marVAC® und Zubehör        marVAC® smoke evacuator and accessories        Evacuación de gases de combustión marVAC® y accesorios        Évacuateur de fumée marVAC® et accessoires        Aspiratore di fumo marVAC® e accessori</p>		<p>125-130</p>



<p>Nervstimulator NervScout          NervScout Nerve Stimulator          Estimulador de nervios NervScout          Neurostimulateur NervScout          Neurostimolatore NervScout</p>		<p>131-133</p>
<p>Übersicht der elektrochirurgischen Geräte          Overview of electrosurgical units          Resumen de aparatos electroquirúrgicos          Résumé des bistouris électrochirurgicaux          Elenco degli apparecchi elettrochirurgici</p>		<p>135-140</p>
<p>Fußschalter          Foot switches          Interruptores de pie          Interrupteurs à pédale          Interruttori a pedale</p>		<p>141-150</p>
<p>Netzkabel          Mains cables          Cables de conexión a la red          Câbles d'alimentation          Cavi d'alimentazione</p>		<p>151-152</p>
<p>Fahrgestelle          Trolleys          Soportes móviles          Supports roulants (chariots)          Carrelli</p>		<p>153-159</p>
<p>Zubehörsätze          Accessory sets          Juegos de accesorios          Jeux d'accessoires          Serie di accessori</p>		<p>161-183</p>
<p>Nummern-Index          Index of order numbers          Índice de números de referencia          Index numérique des références de commande          Elenco dei codici</p>		<p>185-187</p>



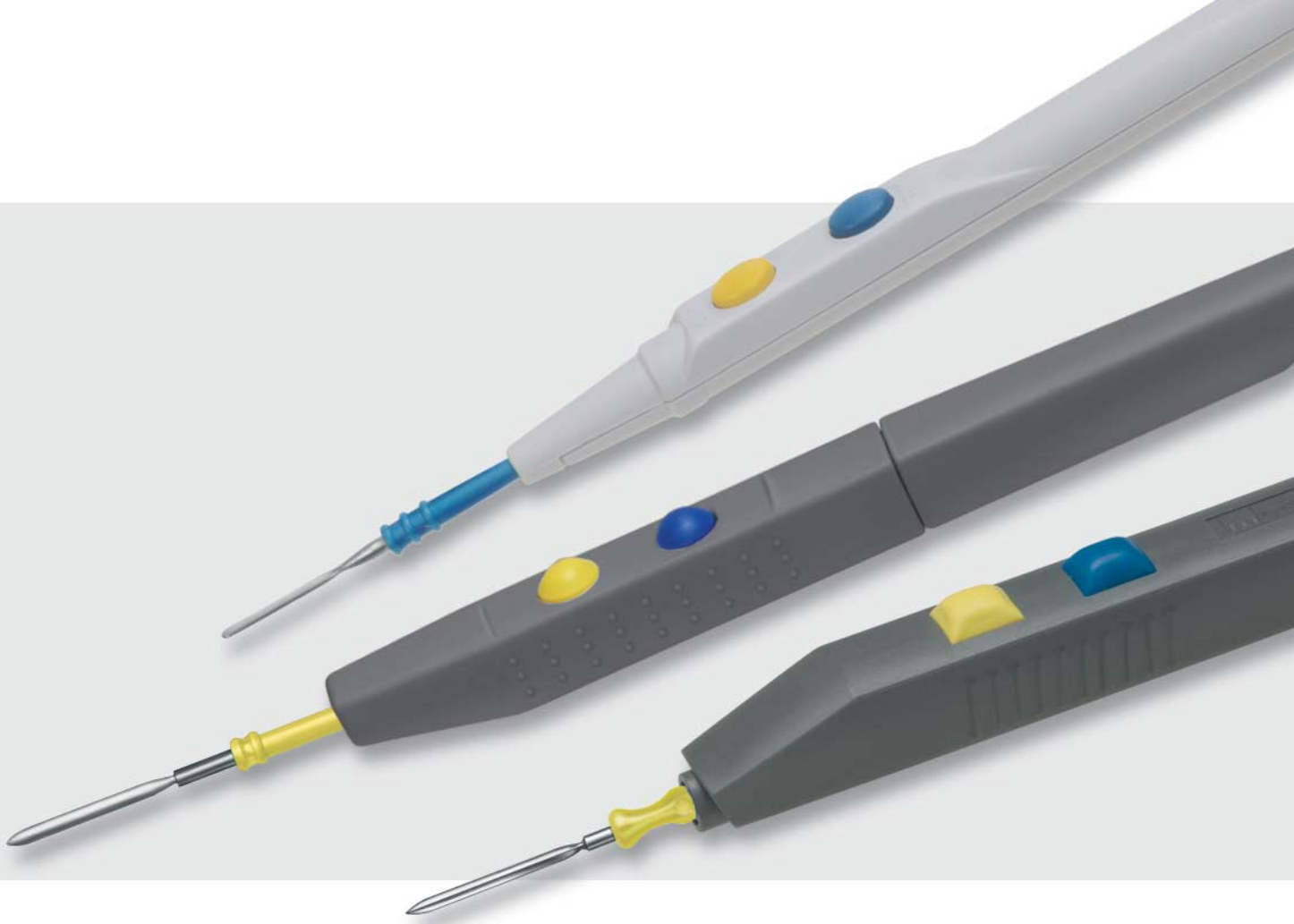

MONOPOLARE ELEKTRODEN-HANDGRIFFE  
MONOPOLAR ELECTRODE HANDLES  
MANGOS PORTA-ELECTRODOS MONOPOLARES  
MANCHES PORTE-ELECTRODES MONOPOLAIRES  
MANICI PORTAELETTRODI MONOPOLARI

5-12

Monopolare Elektroden-Handgriffe  
 Monopolar electrode handles  
 Mangos porta-electrodos monopolares  
 Manches porte-électrode monopolaires  
 Manici portaelettrodi monopolari

Passend für **maxium®/ME 411/ME 401/ME 400/ME 200**  
 Suitable for **ME MB 3/ME MB 2/ME MB 1/ME M1/ME 102**  
 Para  
 Pour  
 Per

Ø 4 mm

1/2



Ø 12,5 mm

80-220-00-04 *max. 3000 V<sub>p</sub>*

**KLS Martin/Aesculap/Berchtold**

Elektroden-Handgriff ohne Tasten, mit großem Koax-Stecker und 4 m Anschlusskabel  
 Electrode handle without pushbuttons, with large coax plug and connection cable of 4 m  
 Mango porta-electrodos sin teclas con clavija coaxial y cable de conexión de 4 m  
 Manche porte-électrode sans interrupteur, avec grande fiche coax et câble de raccordement de 4 m  
 Manico portaelettrodi senza tasti, con spina coassiale grande e cavo di connessione da 4 m

Ø 4 mm

1/2



Ø 12,5 mm

80-217-02-04 *max. 5500 V<sub>p</sub>*

**KLS Martin/Aesculap/Berchtold**

Elektroden-Handgriff mit zwei Tasten, großem Koax-Stecker und 4 m Anschlusskabel  
 Electrode handle with two pushbuttons, large coax plug and connection cable of 4 m  
 Mango porta-electrodos con dos teclas, clavija coaxial grande y cable de conexión de 4 m  
 Manche porte-électrode avec interrupteur digital double, grande fiche coax et câble de raccordement de 4 m  
 Manico portaelettrodi con due tasti, spina coassiale grande e cavo di connessione da 4 m

80-217-12-04 *max. 5500 V<sub>p</sub>*

**KLS Martin/Aesculap/Berchtold**

Elektroden-Handgriff mit zwei Tasten, großem Koax-Stecker und 5 m Anschlusskabel  
 Electrode handle with two pushbuttons, large coax plug and connection cable of 5 m  
 Mango porta-electrodos con dos teclas, clavija coaxial grande y cable de conexión de 5 m  
 Manche porte-électrode avec interrupteur digital double, grande fiche coax et câble de raccordement de 5 m  
 Manico portaelettrodi con due tasti, spina coassiale grande e cavo di connessione da 5 m

Ø 4 mm

1/2



Ø 12,5 mm

Surgi-Pen

80-219-02-04 *max. 4000 V<sub>p</sub>*

**KLS Martin/Aesculap/Berchtold**

Elektroden-Handgriff mit zwei Tasten, großem Koax-Stecker und 4 m Anschlusskabel  
 Electrode handle with two pushbuttons, large coax plug and connection cable of 4 m  
 Mango porta-electrodos con dos teclas, clavija coaxial grande y cable de conexión de 4 m  
 Manche porte-électrode avec interrupteur digital double, grande fiche coax et câble de raccordement de 4 m  
 Manico portaelettrodi con due tasti, spina coassiale grande e cavo di connessione da 4 m

80-219-12-04 *max. 4000 V<sub>p</sub>*

**KLS Martin/Aesculap/Berchtold**

Elektroden-Handgriff mit zwei Tasten, großem Koax-Stecker und 5 m Anschlusskabel  
 Electrode handle with two pushbuttons, large coax plug and connection cable of 5 m  
 Mango porta-electrodos con dos teclas, clavija coaxial grande y cable de conexión de 5 m  
 Manche porte-électrode avec interrupteur digital double, grande fiche coax et câble de raccordement de 5 m  
 Manico portaelettrodi con due tasti, spina coassiale grande e cavo di connessione da 5 m





Passend für **maxium®/ME 411/ME 401/ME 400/ME 200**  
 Suitable for **ME MB 3/ME MB 2/ME MB 1/ME M1/ME 102**  
 Para  
 Pour  
 Per

Ø 4 mm

1/2



80-210-12-04 **max. 5500 V<sub>p</sub>**

**KLS Martin/Erbe intern. Version/Valleylab**

Elektroden-Handgriff mit zwei Tasten, 3-Pin-Stecker und 5 m Anschlusskabel  
 Electrode handle with two pushbuttons, 3-pin plug and connection cable of 5 m  
 Mango porta-electrodos con dos teclas, clavija de 3 patillas y cable de conexión de 5 m  
 Manche porte-électrode avec interrupteur digital double, fiche à 3 broches et câble de raccordement de 5 m  
 Manico portaelettrodi con due tasti, spina a 3-spire e cavo di connessione da 5 m



Ø 4 mm

1/2



Surgi-Pen

80-219-42-04 **max. 4000 V<sub>p</sub>**

**KLS Martin/Erbe intern. Version/Valleylab**

Elektroden-Handgriff mit zwei Tasten, 3-Pin-Stecker und 4 m Anschlusskabel  
 Electrode handle with two pushbuttons, 3-pin plug and connection cable of 4 m  
 Mango porta-electrodos con dos teclas, clavija de 3 patillas y cable de conexión de 4 m  
 Manche porte-électrode avec interrupteur digital double, fiche à 3 broches et câble de raccordement de 4 m  
 Manico portaelettrodi con due tasti, spina a 3-spire e cavo di connessione da 4 m



Ø 4 mm

1/2



80-225-00-04 **max. 4000 V<sub>p</sub>**

Elektrodenhandgriff mit 2 Tasten, mit abnehmbarem Kabel  
 Electrode handle with 2 pushbuttons, with detachable cable  
 Mango portaelectrodos con 2 botones, con cable desmontable  
 Manche d'électrode avec 2 touches, avec câble amovible  
 Impugnatura per elettrodi a due pulsanti, con cavo estraibile



80-225-01-04 **max. 4000 V<sub>p</sub>**

**KLS Martin/Aesculap/Berchtold**

Anschlusskabel 4 m Länge  
 Connecting cable 4 m  
 Cable de conexión de 4 m de longitud  
 Câble de raccordement long de 4 m  
 Cavo di collegamento della lunghezza di 4 m



80-225-02-04 **max. 4000 V<sub>p</sub>**

**maxium® „e“-Version, Erbe ACC/ICC/VIO**

Anschlusskabel 4 m Länge  
 Connecting cable 4 m  
 Cable de conexión de 4 m de longitud  
 Câble de raccordement long de 4 m  
 Cavo di collegamento della lunghezza di 4 m

Monopolare Elektroden-Handgriffe  
 Monopolar electrode handles  
 Mangos porta-electrodos monopolares  
 Manches porte-électrode monopolaires  
 Manici portaelettrodi monopolari

Passend für **maxium® „e“-Version**  
 Suitable for  
 Para  
 Pour  
 Per



80-220-30-04 *max. 3000 V<sub>p</sub>*

**maxium® „e“-Version/Erbe ICC/ACC/VIO**

Elektroden-Handgriff ohne Taste, mit 5-mm-Stecker und 4 m Anschlusskabel  
 Electrode handle without pushbutton, with 5-mm plug and connection cable of 4 m  
 Mango porta-electrodos sin tecla, con clavija de 5 mm y cable de conexión de 4 m  
 Manche porte-électrode sans interrupteur, avec fiche de 5 mm et câble de raccordement de 4 m  
 Manico portaelettrodi senza tasto, con spina da 5 mm e cavo di connessione da 4 m



80-217-32-04 *max. 5500 V<sub>p</sub>*

**maxium® „e“-Version/Erbe ICC/ACC/VIO**

Elektroden-Handgriff mit zwei Tasten, mit 5-mm-Stecker und 4 m Anschlusskabel  
 Electrode handle with two pushbuttons, with 5-mm plug and connection cable of 4 m  
 Mango porta-electrodos con dos teclas, clavija de 5 mm y cable de conexión de 4 m  
 Manche porte-électrode avec interrupteur digital double, fiche de 5 mm et câble de raccordement de 4 m

Passend für **maxium® „i“-Version, ME MB 3 „i“-Version, ME MB 2 „i“-Version**  
 Suitable for  
 Para  
 Pour  
 Per



80-220-40-04 *max. 3000 V<sub>p</sub>*

**maxium® „i“-Version/ME MB 3 „i“-Version/ME MB 2 „i“-Version/Valleylab/Bovie**

Elektroden-Handgriff ohne Tasten, mit 8-mm-Stecker und 4 m Anschlusskabel für Valleylab-Geräte  
 Electrode handle without pushbuttons, with 8-mm plug and connection cable of 4 m, for Valleylab units  
 Mango porta-electrodos sin teclas, con clavija de 8 mm y cable de conexión de 4 m para aparatos Valleylab  
 Manche porte-électrode sans interrupteur, avec fiche de 8 mm et câble de raccordement de 4 m pour appareils Valleylab  
 Manico portaelettrodi senza tasti, con spina da 8 mm e cavo di connessione da 4 m per apparecchi Valleylab



Passend für **maxium®**/ME 411/ME 401/ME 400/ME 200  
 Suitable for **ME MB 3/ME MB 2/ME MB 1/ME M1/ME 102**  
 Para  
 Pour  
 Per



80-221-02-04 **max. 4100 V<sub>p</sub>** **STERILE IEO**  
**KLS Martin/Erbe intern. Version/Valleylab**

Einmal-Handgriff mit Lanzette, steril verpackt, 4 m Anschlusskabel, VE=10 Stück  
 Disposable handle with lancet, sterile packed, connection cable of 4 m, SU=10/pack  
 Mango desechable con lanceta, envase estéril, cable de conexión de 4 m, UV=10 piezas  
 Manche à usage unique avec lancette, emballage stérile, câble de raccordement de 4 m, UC=10 unités  
 Manico monouso con lancetta, imballaggio sterile, cavo di connessione da 4 m, UV=10 pezzi

*Passend für Aktivelektroden mit Ø 2,4 mm (siehe Seite 16)*  
*For active electrodes Ø 2.4 mm (see page 16)*  
*Para electrodos activos con Ø 2,4 mm (véase página 16)*  
*Pour électrodes actives Ø 2,4 mm (voir page 16)*  
*Per elettrodi attivi con Ø 2,4 mm (vedi a pag. 16)*



80-210-16-04 **max. 4000 V<sub>p</sub>**  
**KLS Martin/Erbe intern. Version/Valleylab**

Elektroden-Handgriff mit zwei Tasten, 3-Pin-Stecker und 4 m Anschlusskabel  
 Electrode handle with two pushbuttons, 3-pin plug and connection cable of 4 m  
 Mango porta-electrodos con dos teclas, clavija de 3 patillas y cable de conexión de 4 m  
 Manche porte-électrode avec interrupteur digital double, fiche à 3 broches et cable de raccordement de 4 m  
 Manico porta elettrodi con due tasti, spina a 3-spire e cavo di connessione da 4 m



80-210-03-04 **max. 5000 V<sub>p</sub>**  
**KLS Martin/Erbe intern. Version/Valleylab**

Elektroden-Handgriff mit zwei Tasten, 3-Pin-Stecker und 4 m Anschlusskabel, 50 Aufbereitungszyklen  
 Electrode handle with two pushbuttons, 3-pin plug and connection cable of 4 m, 50 reprocessing cycles  
 Mango porta-electrodos con dos teclas, clavija de 3 patillas y cable de conexión de 4 m, 50 ciclos de reprocesamiento  
 Manche porte-électrode avec interrupteur digital double, fiche à 3 broches et cable de raccordement de 4 m, 50 cycles de traitement  
 Manico porta elettrodi con due tasti, spina a 3-spire e cavo di connessione da 4 m, 50 cicli di ricondizionamento

Monopolare Elektroden-Handgriffe  
 Monopolar electrode handles  
 Mangos porta-electrodos monopolares  
 Manches porte-électrode monopolaires  
 Manici portaelettrodi monopolari

Passend für **MD 62/ME K1/ME K2/ME K3/ME 82/Minicutter**

Suitable for

Para

Pour

Per

Ø 1,6 mm

1/2



Ø 12,5 mm

80-214-10-04 *max. 3500 V<sub>p</sub>*

**KLS Martin**

Dental-Elektroden-Handgriff ohne Taste, mit großem Koax-Stecker und 3 m Anschlusskabel

Dental electrode handle without pushbutton, with large coax plug and connection cable of 3 m

Mango porta-electrodos dental sin tecla, con clavija coaxial grande y cable de conexión de 3 m

Manche porte-électrode dentaire sans interrupteur digital, avec grande fiche coax et câble de raccordement de 3 m

Manico portaelettrodi dentale senza tasto, con spina coassiale grande e cavo di connessione da 3 m

Ø 1,6 mm

1/2



Ø 12,5 mm

80-214-11-04 *max. 2000 V<sub>p</sub>*

**KLS Martin**

Dental-Elektroden-Handgriff mit einer Taste, mit großem Koax-Stecker und 3 m Anschlusskabel

Dental electrode handle with a pushbutton, with large coax plug and connection cable of 3 m

Mango porta-electrodos dental con una tecla, con clavija coaxial grande y cable de conexión de 3 m

Manche porte-électrode dentaire avec un interrupteur digital, avec grande fiche coax et câble de raccordement de 3 m

Manico portaelettrodi dentale con un tasto, con spina coassiale grande e cavo di connessione da 3 m

Ø 4 mm

1/2



Ø 12,5 mm

80-217-01-04 *max. 5500 V<sub>p</sub>*

**KLS Martin**

Elektroden-Handgriff mit einer Taste, großem Koax-Stecker und 4 m Anschlusskabel

Electrode handle with a pushbutton, large coax plug and connection cable of 4 m

Mango porta-electrodos con una tecla, clavija coaxial grande y cable de conexión de 4 m

Manche porte-électrode avec un interrupteur digital, grande fiche coax et câble de raccordement de 4 m

Manico portaelettrodi con un tasto, spina coassiale grande e cavo di connessione da 4 m



Passend für KLS-Martin-Geräte aus unserem früheren Programm  
 Suitable for KLS Martin units of our former program  
 Para aparatos KLS Martin de nuestra anterior gama de producción  
 Pour appareils KLS Martin de notre ancienne gamme  
 Per apparecchi KLS Martin della nostra gamma precedente

Ø 1,6 mm



80-214-00-04 *max. 3500 V<sub>p</sub>*

**Berchtold**

Dental-Elektroden-Handgriff ohne Taste, mit kleinem Koax-Stecker und 3 m Anschlusskabel  
 Dental electrode handle without pushbutton, with small coax plug and connection cable of 3 m  
 Mango porta-electrodos dental sin tecla, con clavija coaxial pequeña y cable de conexión de 3 m  
 Manche porte-électrode dentaire sans interrupteur digital, avec petite fiche coax et câble de raccordement de 3 m  
 Manico portaelettrodi dentale senza tasto, con spina coassiale piccola e cavo di connessione da 3 m

Ø 1,6 mm



80-214-01-04 *max. 2000 V<sub>p</sub>*

**Berchtold**

Dental-Elektroden-Handgriff mit einer Taste, mit kleinem Koax-Stecker und 3 m Anschlusskabel  
 Dental electrode handle with one pushbutton, small coax plug and connection cable of 3 m  
 Mango porta-electrodos dental con una tecla, con clavija coaxial pequeña y cable de conexión de 3 m  
 Manche porte-électrode dentaire avec un interrupteur digital, avec petite fiche coax et câble de raccordement de 3 m  
 Manico portaelettrodi dentale con un tasto, con spina coassiale piccola e cavo di connessione da 3 m

## NON-CE



80-213-01-04 *max. 750 V<sub>p</sub>*

Elektroden-Handgriff für Elektroden Ø 1,6 mm  
 Electrode handle for electrodes Ø 1.6 mm  
 Mango porta-electrodos para electrodos Ø 1,6 mm  
 Manche porte-électrode pour électrodes Ø 1,6 mm  
 Manico portaelettrodi per elettrodi Ø mm 1,6

## NON-CE



80-280-30-04 *max. 4000 V<sub>p</sub>*

3 m/10 ft.  
 Anschlusskabel, einpolig,  
 für Griff 80-213-01-04  
 Connection cable, monopolar,  
 for handle 80-213-01-04  
 Cable de conexión, monopolar,  
 para mango 80-213-01-04  
 Câble de raccordement, monopolaire,  
 pour manche 80-213-01-04  
 Cavo di connessione, monopolare,  
 per manico 80-213-01-04

Handgriffe · Handles · Mangos · Manches · Manici

Gerätetyp Type of unit Tipo del aparato Type d'appareil Tipo d'apparecchio	80-220-00-04	80-217-01-04	80-217-02-04	80-217-12-04	80-219-02-04	80-219-12-04	80-221-02-04	80-210-03-04	80-210-16-04	80-210-12-04	80-214-10-04	80-214-11-04	80-181-02-04
maxium®	x*		x	x	x	x	x	x	x	x	x*		x*
ME 411	x*		x	x	x	x	x	x	x	x	x*		x*
ME 401	x*		x	x	x	x	x	x	x	x	x*		x*
ME 400	x*		x	x	x	x	x	x	x	x	x*		x*
ME 200	x*		x	x	x	x	x	x	x	x	x*		x*
ME MB 1	x*		x	x	x	x	x	x	x	x	x*		x*
ME M1	x*		x	x	x	x	x	x	x	x	x*		x*
ME MB 2	x*		x	x	x	x	x	x	x	x	x*		x*
ME MB 3	x*		x	x	x	x	x	x	x	x	x*		
ME 81	x*		x	x	x	x	x	x	x	x	x*		
ME 82	x*	x									x*		x
Minicutter	x*	x									x*		x
ME 102	x*		x	x	x	x	x	x	x	x	x*		
ME 80	x*		x	x	x	x	x	x	x	x			
ME 50	x*		x	x	x	x	x	x	x	x			
ME K1	x*	x									x*		x
ME K2	x*	x									x*		x
MD 60	x*	x									x*		x
MD 70	x*	x									x*		x
MD 62	x*	x									x*		x
<b>Kombination</b> <b>Combination</b> <b>Combinación</b> <b>Combinaison</b> <b>Combinazione</b>													
maxium®/Beamer													x
MB 181/ME 411													x
MB 181/ME CD1													x

x\* = bei Verwendung eines Fußschalters  
 for use with foot switch  
 usando un interruttore de pie  
 pour utilisation avec un interrupteur à pédale  
 per l'uso di un interruttore a pedale



MONOPOLARE ELEKTRODEN  
MONOPOLAR ELECTRODES  
ELECTRODOS MONOPOLARES  
ELECTRODES MONOPOLAIRES  
ELETTRODI MONOPOLARI

13-35

Monopolare Elektroden  
 Monopolar electrodes  
 Electrodo monopolares  
 Electrodes monopolaires  
 Elettrodi monopolari

*KLS-Martin-SYN-Elektroden mit farbkodierter Kunststoffisolation*  
*KLS Martin SYN electrodes with color-coded plastic insulation*  
*SYN electrodoos KLS Martin con aislamiento de plástico en color codificado*  
*SYN électrodes KLS Martin avec isolation en matière plastique avec code couleur*  
*SYN elettrodi KLS Martin con isolamento in materiale plastico con codice colore*

*Aktivelektroden mit Ø 4 mm*  
*Active electrodes Ø 4 mm*  
*Electrodoos activos con Ø 4 mm*  
*Electrodes actives Ø 4 mm*  
*Elettrodi attivi Ø 4 mm*

Ø 4 mm  **max. 4000 V<sub>p</sub>**



80-510-06-04

Lanzettelektrode, gerade, VE = 5 Stück  
 Lancet electrode, straight, SU = 5/pack  
 Electrodo de lanceta, recto, UV = 5 piezas  
 Electrode lancette, droite, UC = 5 unités  
 Elettrodo a lancetta, retto, UV = 5 pezzi



80-511-06-04

Lanzettelektrode, abgewinkelt, isoliert  
 Lancet electrode, angled, insulated  
 Electrodo de lanceta, acodado, aislado  
 Electrode lancette, coudée, isolée  
 Elettrodo a lancetta, angolato, isolato



80-515-06-04

Messerelektrode, VE = 5 Stück  
 Knife electrode, SU = 5/pack  
 Electrodo de cuchillo, UV = 5 piezas  
 Electrode couteau, UC = 5 unités  
 Elettrodo a bisturi, UV = 5 pezzi

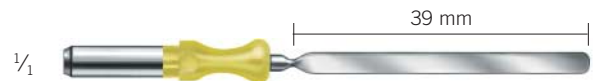

80-516-06-04

Mammaria-Spatel  
 Mammary spatula (electrode)  
 Electrodo de mammaria  
 Electrode spatule  
 Elettrodo a mammaria



80-520-06-04

Nadelelektrode, VE = 5 Stück  
 Needle electrode, SU = 5/pack  
 Electrodo de aguja, UV = 5 piezas  
 Electrode aiguille, UC = 5 unités  
 Elettrodo ad ago, UV = 5 pezzi



80-521-04-04

Nadelelektrode isoliert  
 Needle electrode insulated  
 Electrodo de aguja aislado  
 Electrode aiguille isolée  
 Elettrodo ad ago isolato



80-521-02-04

Nadelelektrode, VE = 5 Stück  
 Needle electrode, SU = 5/pack  
 Electrodo de aguja, UV = 5 piezas  
 Electrode aiguille, UC = 5 unités  
 Elettrodo ad ago, UV = 5 pezzi



80-522-04-04

Nadelelektrode isoliert  
 Needle electrode insulated  
 Electrodo de aguja aislado  
 Electrode aiguille isolée  
 Elettrodo ad ago isolato





*Aktivelektroden mit Ø 4 mm*  
*Active electrodes Ø 4 mm*  
*Electrodos activos con Ø 4 mm*  
*Electrodes actives Ø 4 mm*  
*Elettrodi attivi Ø 4 mm*

**max. 4000 V<sub>p</sub>**



80-542-06-04  
 Drahtschlingenelektrode, Wolfram  
 Wire loop electrode, tungsten  
 Electrodo de asa de alambre, tungsteno  
 Electrode anse en fil, en tungstène  
 Elettrodo ad ansa di filo, tungsteno



80-550-06-04  
 Bandschlingenelektrode  
 Ribbon loop electrode  
 Electrodo de asa de cinta  
 Electrode boucle  
 Elettrodo ad ansa a nastro



80-560-06-04  
 Kugelelektrode, VE = 5 Stück  
 Ball electrode, SU = 5/pack  
 Electrodo de bola, UV = 5 piezas  
 Electrode boule, UC = 5 unités  
 Elettrodo a sfera, UV = 5 pezzi



80-562-06-04  
 Kugelelektrode, VE = 5 Stück  
 Ball electrode, SU = 5/pack  
 Electrodo de bola, UV = 5 piezas  
 Electrode boule, UC = 5 unités  
 Elettrodo a sfera, UV = 5 pezzi



80-580-06-04  
 Elektroden-Satz, bestehend aus: 1 x 80-510-06-04  
 Electrode set, consisting of: 1 x 80-515-06-04  
 Set electrodos, compuesto de: 1 x 80-520-06-04  
 Set électrodes, composé de: 1 x 80-560-06-04  
 Set elettrodi, composto da: 1 x 80-562-06-04

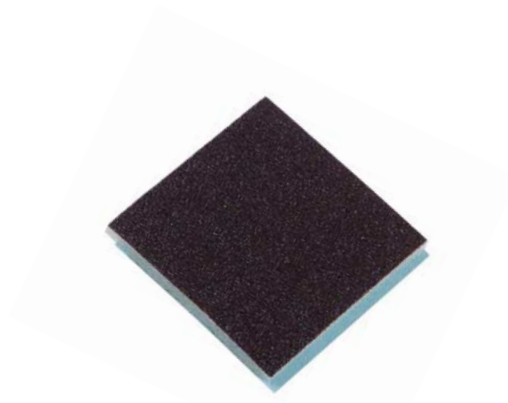

80-505-00-04 **STERILE IEO**  
 Reinigungspad für Elektroden, steril verpackt, VE = 100 Stück  
 Cleaning pad for electrodes, sterile packed, SU = 100 /pack  
 Almohadilla de limpieza para electrodos, embalado estéril, UV = 100 piezas  
 Tampon de nettoyage pour électrodes, emballage stérile, UC = 100 unités  
 Tampone di pulizia per elettrodi, imballaggio sterile, UV = 100 pezzi

Monopolare Elektroden  
 Monopolar electrodes  
 Electrodoes monopolares  
 Electrodes monopolaires  
 Elettrodi monopolari

*KLS-Martin-SYN-Elektroden mit farbkodierter Kunststoffisolation*  
*KLS Martin SYN electrodes with color-coded plastic insulation*  
*SYN electrodoes KLS Martin con aislamiento de plástico en color codificado*  
*SYN électrodes KLS Martin avec isolation en matière plastique avec code couleur*  
*SYN elettrodi KLS Martin con isolamento in materiale plastico con codice colore*

*Aktivelektroden mit Ø 2,4 mm*  
*Active electrodes Ø 2.4 mm*  
*Electrodoes activos con Ø 2,4 mm*  
*Electrodes actives Ø 2,4 mm*  
*Elettrodi attivi Ø 2,4 mm*

Ø 2,4 mm 



80-520-09-04 **max. 2900 V<sub>p</sub>**

Nadelektrode für die Mikrodissektion, Wolframspitze,  
 VE = 5 Stück, wiederverwendbar  
 Needle electrode for dissection, tungsten tip,  
 5 items/pack, reusable  
 Electrodo de aguja para la disección, punta de tungsteno,  
 UE = 5 unidades, reutilizable  
 Electrode aiguille pour dissection, pointe en tungstène,  
 UE = 5 pièces, réutilisable  
 Elettrodo ad ago per dissezione, punta in tungsteno,  
 UV = 5 unità, riutilizzabile



80-520-10-04 **max. 2900 V<sub>p</sub>** **STERILE** 

Nadelektrode für die Mikrodissektion, Wolframspitze,  
 VE = 5 Stück, steril verpackt, wiederverwendbar  
 Needle electrode for dissection, tungsten tip,  
 5 items/pack, sterile packed, reusable  
 Electrodo de aguja para la disección, punta de tungsteno,  
 UE = 5 unidades, embalado estéril, reutilizable  
 Electrode aiguille pour dissection, pointe en tungstène,  
 UE = 5 pièces, emballage stérile, réutilisable  
 Elettrodo ad ago per dissezione, punta in tungsteno,  
 UV = 5 unità, imballaggio sterile, riutilizzabile



80-510-08-04 **max. 3250 V<sub>p</sub>**

Lanzettelektrode, gerade  
 Lancet electrode, straight  
 Electrodo de lanceta, recto  
 Electrode lancette, droite  
 Elettrodo a lancetta, retto



80-515-08-04 **max. 3250 V<sub>p</sub>**

Messerelektrode  
 Knife electrode  
 Electrodo de cuchillo  
 Electrode couteau  
 Elettrodo a bisturi



80-520-08-04 **max. 3250 V<sub>p</sub>**

Nadelektrode  
 Needle electrode  
 Electrodo de aguja  
 Electrode aiguille  
 Elettrodo ad ago



80-542-08-04 **max. 3250 V<sub>p</sub>**

Drahtschlingenelektrode, Wolfram  
 Wire loop electrode, tungsten  
 Electrodo de asa de alambre, tungsteno  
 Electrode anse en fil, en tungstène  
 Elettrodo ad ansa di filo, tungsteno



80-562-08-04 **max. 3250 V<sub>p</sub>**

Kugелеlektrode  
 Ball electrode  
 Electrodo de bola  
 Electrode boule  
 Elettrodo a sfera



*KLS-Martin-Edelstahlelektroden*  
*KLS Martin stainless steel electrodes*  
*Electrodos KLS Martin de acero inoxidable*  
*Electrodes KLS Martin en acier inoxydable*  
*Elettrodi KLS Martin in acciaio inox*

*Aktivelektroden mit Ø 4 mm*  
*Active electrodes Ø 4 mm*  
*Electrodos activos con Ø 4 mm*  
*Electrodes actives Ø 4 mm*  
*Elettrodi attivi Ø 4 mm*



80-540-04-04 = Ø 5 mm  
 80-542-04-04 = Ø 10 mm  
 80-545-04-04 = Ø 20 mm  
 Drahtschlingenelektrode  
 Wire loop electrode  
 Electrodo de asa de alambre  
 Electrode anse en fil  
 Elettrodo ad ansa di filo



80-550-04-04 = Ø 10 mm  
 80-552-04-04 = Ø 15 mm  
 Bandschlingenelektrode  
 Ribbon loop electrode  
 Electrodo de asa de cinta  
 Electrode boucle  
 Elettrodo ad ansa a nastro



80-519-04-04  
 Nadelelektrode  
 Needle electrode  
 Electrodo de aguja  
 Electrode aiguille  
 Elettrodo ad ago



80-570-04-04 = 8 x 10 mm  
 80-572-04-04 = 10 x 10 mm  
 80-574-04-04 = 12 x 10 mm  
 Plattenelektrode  
 Plate electrode  
 Electrodo de placa  
 Electrode plaque  
 Elettrodo a piastra



80-510-04-04  
 Lanzettelektrode, gerade  
 Lancet electrode, straight  
 Electrodo de lanceta, recto  
 Electrode lancette, droite  
 Elettrodo a lancetta, retto



80-511-04-04  
 Lanzettelektrode, abgewinkelt  
 Lancet electrode, angled  
 Electrodo de lanceta, acodado  
 Electrode lancette, coudée  
 Elettrodo a lancetta, angolato



80-515-04-04  
 Messerelektrode  
 Knife electrode  
 Electrodo de cuchillo  
 Electrode couteau  
 Elettrodo a bisturi



80-516-04-04  
 Mammaria-Spatel  
 Mammary spatula (electrode)  
 Electrodo de mammaria  
 Electrode spatule  
 Elettrodo a mammaria



80-520-04-04  
 Nadelelektrode  
 Needle electrode  
 Electrodo de aguja  
 Electrode aiguille  
 Elettrodo ad ago



80-560-04-04 = Ø 2 mm  
 80-562-04-04 = Ø 4 mm  
 80-563-04-04 = Ø 5 mm  
 Kugelelektrode  
 Ball electrode  
 Electrodo de bola  
 Electrode boule  
 Elettrodo a sfera

Monopolare Elektroden zur Konisation  
 Monopolar electrodes for conization  
 Electrodo monopolar para conización  
 Electrodes monopolaires pour conisation  
 Elettrodi monopolari per conizzazione

*Aktivelektroden mit Ø 4 mm*      *Wolfram*  
*Active electrodes Ø 4 mm*      *Tungsten*  
*Electrodo activos con Ø 4 mm*      *Tungsteno*  
*Electrodes actives Ø 4 mm*      *En tungstène*  
*Elettrodi attivi Ø 4 mm*      *Tungsteno*

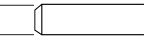
Ø 4 mm  **max. 650 V<sub>p</sub>**



80-680-12-04  
 Konisationselektrode  
 Conization electrode  
 Electrodo para conización  
 Electrode pour l'électroconisation  
 Elettrodo per conizzazione



80-681-12-04  
 Konisationselektrode  
 Conization electrode  
 Electrodo para conización  
 Electrode pour l'électroconisation  
 Elettrodo per conizzazione

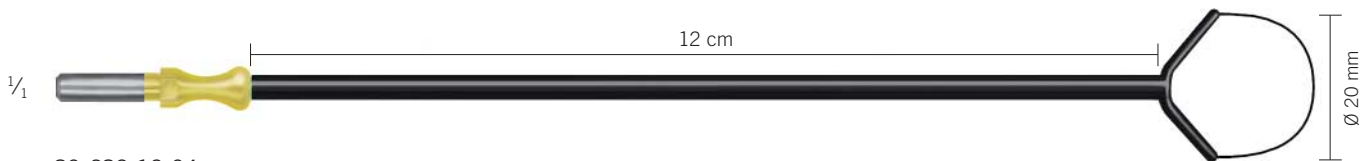

80-682-12-04  
 Konisationselektrode  
 Conization electrode  
 Electrodo para conización  
 Electrode pour l'électroconisation  
 Elettrodo per conizzazione



80-683-12-04  
 Konisationselektrode  
 Conization electrode  
 Electrodo para conización  
 Electrode pour l'électroconisation  
 Elettrodo per conizzazione



**Aktivelektroden mit Ø 4 mm**  
**Active electrodes Ø 4 mm**  
**Electrodoos activos con Ø 4 mm**  
**Electrodes actives Ø 4 mm**  
**Elettrodi attivi Ø 4 mm**

*Wolfram*  
*Tungsten*  
*Tungsteno*  
*En tungstène*  
*Tungsteno*

Weitere Informationen entnehmen Sie bitte der separaten Broschüre.

For further information please refer to our separate product brochure.

Encontrará informaciones adicionales en el folleto individual.

Vous trouverez des informations supplémentaires dans la brochure.

Per ulteriori informazioni vedasi il prospetto separato.



Ø 4 mm

**max. 650 V<sub>p</sub>**

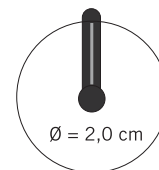
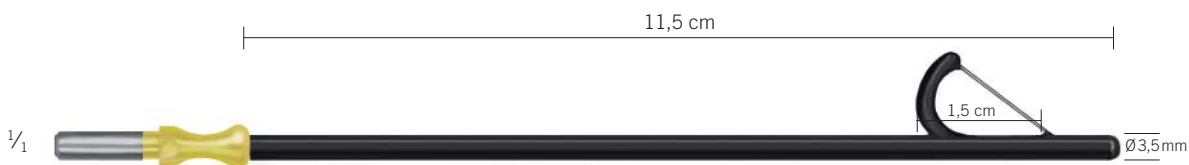

80-684-12-04

Konisationselektrode nach Scarfi,  
 Conization electrode,  
 Electrodo para conización,  
 Electrode pour l'électroconisation,  
 Elettrodo per conizzazione,

Schaftlänge 11,5 cm,  
 length of shaft 11,5 cm,  
 largo del vástago 11,5 cm,  
 longueur de la tige 11,5 cm,  
 lunghezza dell'asta 11,5 cm,

Konus Ø 2,0 cm,  
 cone diameter 2,0 cm,  
 diámetro del cono 2,0 cm,  
 diamètre de cône 2,0 cm,  
 diametro del cono 2,0 cm,

Konuslänge 1,5 cm  
 length of cone 1,5 cm  
 largo del cono 1,5 cm  
 longueur de cône 1,5 cm  
 lunghezza del cono 1,5 cm

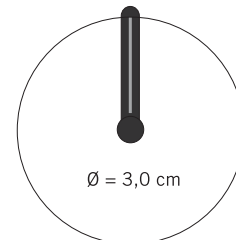

80-685-12-04

Konisationselektrode nach Scarfi,  
 Conization electrode,  
 Electrodo para conización,  
 Electrode pour l'électroconisation,  
 Elettrodo per conizzazione,

Schaftlänge 11,5 cm,  
 length of shaft 11,5 cm,  
 largo del vástago 11,5 cm,  
 longueur de la tige 11,5 cm,  
 lunghezza dell'asta 11,5 cm,

Konus Ø 3,0 cm,  
 cone diameter 3,0 cm,  
 diámetro del cono 3,0 cm,  
 diamètre de cône 3,0 cm,  
 diametro del cono 3,0 cm,

Konuslänge 2,5 cm  
 length of cone 2,5 cm  
 largo del cono 2,5 cm  
 longueur de cône 2,5 cm  
 lunghezza del cono 2,5 cm

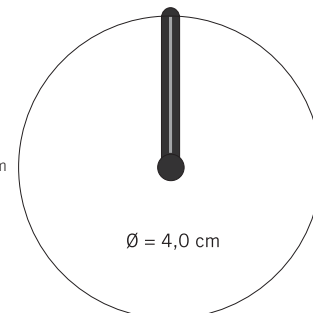
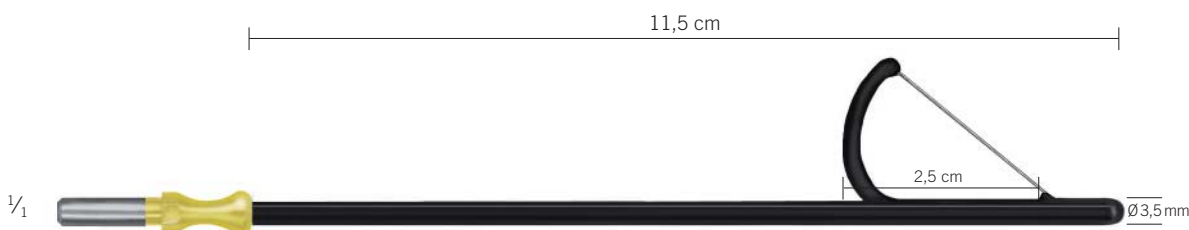

80-686-12-04

Konisationselektrode nach Scarfi,  
 Conization electrode,  
 Electrodo para conización,  
 Electrode pour l'électroconisation,  
 Elettrodo per conizzazione,

Schaftlänge 11,5 cm,  
 length of shaft 11,5 cm,  
 largo del vástago 11,5 cm,  
 longueur de la tige 11,5 cm,  
 lunghezza dell'asta 11,5 cm,

Konus Ø 4,0 cm,  
 cone diameter 4,0 cm,  
 diámetro del cono 4,0 cm,  
 diamètre de cône 4,0 cm,  
 diametro del cono 4,0 cm,

Konuslänge 2,5 cm  
 length of cone 2,5 cm  
 largo del cono 2,5 cm  
 longueur de cône 2,5 cm  
 lunghezza del cono 2,5 cm

Monopolare Elektroden, nicht biegsam  
 Monopolar electrodes, non-flexible  
 Electrodoos monopolaress, no flexibles  
 Electrodes monopolaires, non flexibles  
 Elettrodi monopolari, non flessibili

*Aktivelektroden mit Ø 4 mm*  
*Active electrodes Ø 4 mm*  
*Electrodoos activos con Ø 4 mm*  
*Electrodes actives Ø 4 mm*  
*Elettrodi attivi Ø 4 mm*



80-675-13-04 **max. 3500 V<sub>p</sub>**

Nadelelektrode, isoliert,	blanke Spitze
Needle electrode, insulated,	polished tip
Electrodo de aguja, aislado,	punta brillante
Electrode aiguille, isolée,	pointe polie
Elettrodo ad ago, isolato,	punta lucidata



80-677-12-04 **max. 3500 V<sub>p</sub>**

Nadelelektrode, isoliert,	blanke Spitze
Needle electrode, insulated,	polished tip
Electrodo de aguja, aislado,	punta brillante
Electrode aiguille, isolée,	pointe polie
Elettrodo ad ago, isolato,	punta lucidata



80-510-12-04 **max. 4000 V<sub>p</sub>**

Lanzettelektrode, isoliert
Lancet electrode, insulated
Electrodo de lanceta, aislado
Electrode lancette, isolée
Elettrodo a lancetta, isolato



80-515-12-04 **max. 4000 V<sub>p</sub>**

Messerelektrode, isoliert
Knife electrode, insulated
Electrodo de cuchillo, aislado
Electrode couteau, isolée
Elettrodo a bisturi, isolato

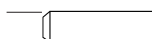

*Aktivelektroden mit Ø 4 mm*  
*Active electrodes Ø 4 mm*  
*Electrodo activos con Ø 4 mm*  
*Electrodes actives Ø 4 mm*  
*Elettrodi attivi Ø 4 mm*

Ø 4 mm  *max. 4000 V<sub>p</sub>*



80-515-14-04

Messerelektrode, kurz, isoliert  
 Knife electrode, short, insulated  
 Electrodo de cuchillo, corto, aislado  
 Electrode couteau, courte, isolée  
 Elettrodo a bisturi, corto, isolato

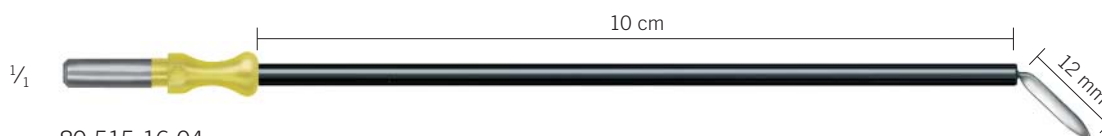

80-515-16-04

Messerelektrode, kurz, abgewinkelt, isoliert  
 Knife electrode, short, angled, insulated  
 Electrodo de cuchillo, corto, acodado, aislado  
 Electrode couteau, courte, coudée, isolée  
 Elettrodo a bisturi, corto, angolato, isolato

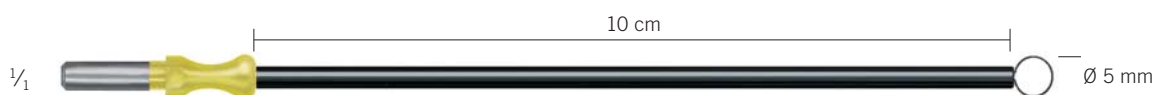

80-540-12-04

Drahtschlingenelektrode, isoliert, Wolfram  
 Wire loop electrode, insulated, tungsten  
 Electrodo de asa de alambre, aislado, tungsteno  
 Electrode anse en fil, isolée, en tungstène  
 Elettrodo ad ansa di filo, isolato, tungsteno

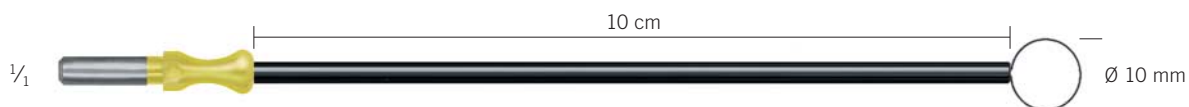

80-542-12-04

Drahtschlingenelektrode, isoliert, Wolfram  
 Wire loop electrode, insulated, tungsten  
 Electrodo de asa de alambre, aislado, tungsteno  
 Electrode anse en fil, isolée, en tungstène  
 Elettrodo ad ansa di filo, isolato, tungsteno

Monopolare Elektroden  
 Monopolar electrodes  
 Electrodo monopolar  
 Electrodes monopolaires  
 Elettrodi monopolari

*Aktivelektroden mit Ø 4 mm*  
*Active electrodes Ø 4 mm*  
*Electrodos activos con Ø 4 mm*  
*Electrodes actives Ø 4 mm*  
*Elettrodi attivi Ø 4 mm*



10 cm



80-674-12-04 **max. 4000 V<sub>p</sub>**

Kugelelektrode, isoliert  
 Ball electrode, insulated  
 Electrodo de bola, aislado  
 Electrode boule, isolée  
 Elettrodo a sfera, isolato

10 cm



80-674-13-04 **max. 4000 V<sub>p</sub>**

Kugelelektrode, isoliert  
 Ball electrode, insulated  
 Electrodo de bola, aislado  
 Electrode boule, isolée  
 Elettrodo a sfera, isolato

13 cm



80-676-13-04 **max. 3500 V<sub>p</sub>**

Kugelelektrode, isoliert  
 Ball electrode, insulated  
 Electrodo de bola, aislado  
 Electrode boule, isolée  
 Elettrodo a sfera, isolato

7 cm



80-534-06-04 **max. 2000 V<sub>p</sub>**

Elektroden-Verlängerung, isoliert, biegsam,	Ø 4 mm/Ø 4 mm
Electrode extension, insulated, flexible,	Ø 4 mm/Ø 4 mm
Extensión de electrodo, aislada, flexible,	Ø 4 mm/Ø 4 mm
Prolongation d'électrode, isolée, flexible,	Ø 4 mm/Ø 4 mm
Prolunga per elettrodo, isolata, flessibile,	Ø 4 mm/Ø 4 mm

12 cm



80-534-12-04 **max. 2000 V<sub>p</sub>**

Elektroden-Verlängerung, isoliert, biegsam,	Ø 4 mm/Ø 4 mm
Electrode extension, insulated, flexible,	Ø 4 mm/Ø 4 mm
Extensión de electrodo, aislada, flexible,	Ø 4 mm/Ø 4 mm
Prolongation d'électrode, isolée, flexible,	Ø 4 mm/Ø 4 mm
Prolunga per elettrodo, isolata, flessibile,	Ø 4 mm/Ø 4 mm





*Aktivelektroden mit Ø 2,4 mm*  
*Active electrodes Ø 2.4 mm*  
*Electrodos activos con Ø 2,4 mm*  
*Electrodes actives Ø 2,4 mm*  
*Elettrodi attivi Ø 2,4 mm*

Ø 2,4 mm 



80-678-10-04 **max. 3250 V<sub>p</sub>**

Messerelektrode, isoliert  
 Knife electrode, insulated  
 Electrodo de cuchillo, aislado  
 Electrode couteau, isolée  
 Elettrodo a bisturi, isolato



80-678-11-04 **max. 3250 V<sub>p</sub>**

Kugelelektrode, isoliert  
 Ball electrode, insulated  
 Electrodo de bola, aislado  
 Electrode boule, isolée  
 Elettrodo a sfera, isolato

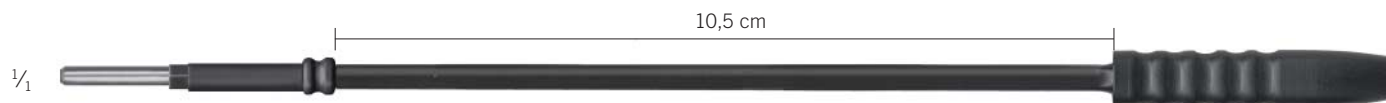

80-678-05-04 **max. 2000 V<sub>p</sub>**

Elektroden-Verlängerung, Ø 2,4 mm / Ø 2,4 mm, Länge = 14 cm  
 Electrode extension, Ø 2.4 mm / Ø 2.4 mm, length = 14 cm  
 Extensión de electrodo, Ø 2,4 mm / Ø 2,4 mm, longitud = 14 cm  
 Rallonge d'électrode, Ø 2,4 mm / Ø 2,4 mm, longueur = 14 cm  
 Prolunga per elettrodo, Ø 2,4 mm / Ø 2,4 mm, lunghezza = 14 cm

Monopolare Elektroden für die HNO  
Monopolar electrodes for ENT  
Electrodos monopolares para la otorrinolaringología  
Electrodes monopolaires pour l'O.R.L.  
Elettrodi monopolari per l'otorinolaringoiatria

Aktivelektroden mit Ø 4 mm  
Active electrodes Ø 4 mm  
Electrodos activos con Ø 4 mm  
Electrodes actives Ø 4 mm  
Elettrodi attivi Ø 4 mm

Ø 4 mm 



Monopolare Elektroden für die Arthroskopie  
 Monopolar electrodes for arthroscopy  
 Electrodoes monopolaes para la artroscopia  
 Electrodes monopolaires pour l'arthroscopie  
 Elettrodi monopolari per l'artroscopia

Monopolare Elektroden  
 Monopolar electrodes  
 Electrodoes monopolaes  
 Electrodes monopolaires  
 Elettrodi monopolari



*Aktivelektroden mit Ø 4 mm*  
*Active electrodes Ø 4 mm*  
*Electrodos activos con Ø 4 mm*  
*Electrodes actives Ø 4 mm*  
*Elettrodi attivi Ø 4 mm*

Ø 4 mm  **max. 5500 V<sub>p</sub>**

11,5 cm



80-690-12-04

Nadelelektrode, isoliert, 90° abgewinkelt  
 Needle electrode, insulated, 90° angled  
 Electrodo de aguja, aislado, acodado 90°  
 Electrode aiguille, isolée, coudée 90°  
 Elettrodo ad ago, isolato, angolo 90°

11,5 cm



80-691-12-04

Nadelelektrode, isoliert, 90° abgewinkelt  
 Needle electrode, insulated, 90° angled  
 Electrodo de aguja, aislado, acodado 90°  
 Electrode aiguille, isolée, coudée 90°  
 Elettrodo ad ago, isolato, angolo 90°

11,5 cm



80-692-12-04

Nadelelektrode, isoliert, 45° abgewinkelt  
 Needle electrode, insulated, 45° angled  
 Electrodo de aguja, aislado, acodado 45°  
 Electrode aiguille, isolée, coudée 45°  
 Elettrodo ad ago, isolato, angolo 45°

12,5 cm



80-693-12-04

Messerelektrode, isoliert, 45° abgewinkelt  
 Knife electrode, insulated, 45° angled  
 Electrodo de cuchillo, aislado, acodado 45°  
 Electrode couteau, isolée, coudée 45°  
 Elettrodo a bisturi, isolato, angolo 45°

11,5 cm



80-694-12-04

Tastelektrode, isoliert, 90° abgewinkelt  
 Probe electrode, insulated, 90° angled  
 Electrodo de sondeo, aislado, acodado 90°  
 Electrode sonde, isolée, coudée 90°  
 Elettrodo sensore, isolato, angolo 90°

11,5 cm



80-695-12-04

Kugelelektrode  
 Ball electrode  
 Electrodo de bola  
 Electrode boule  
 Elettrodo a sfera

Elektroden mit Ø 1,6 mm  
 Electrodes Ø 1.6 mm  
 Electrodo con Ø 1,6 mm  
 Electrodes Ø 1,6 mm  
 Elettrodi Ø 1,6 mm

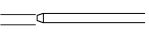
Ø 1,6 mm  max. 500 V<sub>p</sub>



80-461-01-04

Fig. 1

Nadelelektrode, gerade  
 Needle electrode, straight  
 Electrodo de aguja, recto  
 Electrode aiguille, droite  
 Elettrodo ad ago, retto



80-462-01-04

Fig. 1

Nadelelektrode, kurz, gerade  
 Needle electrode, short, straight  
 Electrodo de aguja, corto, recto  
 Electrode aiguille, courte, droite  
 Elettrodo ad ago, corto, retto



80-466-01-04

Fig. 1

Nadelelektrode, gerade  
 Needle electrode, straight  
 Electrodo de aguja, recto  
 Electrode aiguille, droite  
 Elettrodo ad ago, retto



80-463-01-04

Fig. 1

Nadelelektrode, kurz, gerade  
 Needle electrode, short, straight  
 Electrodo de aguja, corto, recto  
 Electrode aiguille, courte, droite  
 Elettrodo ad ago, corto, retto



80-461-02-04

Fig. 2

Nadelelektrode, 45° abgewinkelt  
 Needle electrode, 45° angled  
 Electrodo de aguja, acodado 45°  
 Electrode aiguille, coudée en 45°  
 Elettrodo ad ago, angolo 45°



80-462-02-04

Fig. 2

Nadelelektrode, 45° abgewinkelt  
 Needle electrode, 45° angled  
 Electrodo de aguja, acodado 45°  
 Electrode aiguille, coudée en 45°  
 Elettrodo ad ago, angolo 45°



80-464-02-04

Fig. 2

Nadelelektrode, 45° abgewinkelt, **mit ausziehbarem und kürzbarem Draht**  
 Needle electrode, 45° angled, **with extendable wire that can be cut as well**  
 Electrodo de aguja, acodado 45°, **con alambre extensible que también puede acortarse**  
 Electrode aiguille, coudée 45°, **avec fil extensible et raccourcissable**  
 Elettrodo ad ago, angolo 45°, **con filo metallico estraibile ed accorciabile**



80-461-03-04

Fig. 3

Nadelelektrode, 120° abgewinkelt  
 Needle electrode, 120° angled  
 Electrodo de aguja, acodado 120°  
 Electrode aiguille, coudée en 120°  
 Elettrodo ad ago, angolo 120°



Elektroden mit Ø 1,6 mm  
 Electrodes Ø 1.6 mm  
 Electrodoes con Ø 1,6 mm  
 Electrodes Ø 1,6 mm  
 Elettrodi Ø 1,6 mm

Drahtstärke der Drahtschlingenelektroden = Ø 0,2 mm  
 Wire size of wire loop electrodes = Ø 0.2 mm  
 Grosor del alambre del electrodo de asa = Ø 0,2 mm  
 Épaisseur du fil des électrodes anse = Ø 0,2 mm  
 Spessore filo degli elettrodi ad ansa = Ø 0,2 mm

Ø 1,6 mm  max. 500 V<sub>p</sub>



80-464-38-04

Fig. 2

Nadelelektrode, 45° abgewinkelt,  
**verlängerte Isolation, mit ausziehbarem und kürzbarem Draht**  
 Needle electrode, 45° angled  
**extended insulation, with extendable wire that can be cut as well**  
 Electrodo de aguja, acodado 45°  
**aislamiento prolongado, con alambre extensible que también puede acortarse**  
 Electrode aiguille, coudée 45°  
**isolation rallongée, avec fil extensible et raccourcissable**  
 Elettrodo ad ago, angolo 45°  
**isolamento prolungato, con filo metallico estraibile ed accorciabile**



80-461-04-04

Nadelelektroden nach Dr. Haus, links und rechts, 1 Paar  
 Needle electrodes acc. to Dr. Haus, left and right, 1 pair  
 Electrodoes de aguja según Dr. Haus, izquierdo y derecho, un par  
 Electrodes aiguille selon Dr. Haus, gauche et droite, 1 paire  
 Elettrodi ad ago secondo Dr. Haus, sinistro e destro, 1 paio



80-461-06-04

Fig. 6

Drahtschlingenelektrode, Schaft 45° abgewinkelt  
 Wire loop electrode, shaft 45° angled  
 Electrodo de asa de alambre, vástago acodado 45°  
 Electrode anse, tige coudée en 45°  
 Elettrodo ad ansa, asta curva a 45°



80-461-07-04

Scheibenelektrode, Schaft 45° abgewinkelt  
 Disk electrode, shaft 45° angled  
 Electrodo de disco, vástago acodado 45°  
 Electrode discoïdale, tige coudée en 45°  
 Elettrodo a disco, asta curva a 45°



80-461-11-04

Fig. 11

Drahtschlingenelektrode  
 Wire loop electrode  
 Electrodo de asa de alambre  
 Electrode anse  
 Elettrodo ad ansa



80-462-11-04

Fig. 11

Drahtschlingenelektrode  
 Wire loop electrode,  
 Electrodo de asa de alambre  
 Electrode anse  
 Elettrodo ad ansa



80-461-12-04

Fig. 12

Drahtschlingenelektrode  
 Wire loop electrode  
 Electrodo de asa de alambre  
 Electrode anse  
 Elettrodo ad ansa



80-462-12-04

Fig. 12

Drahtschlingenelektrode  
 Wire loop electrode  
 Electrodo de asa de alambre  
 Electrode anse  
 Elettrodo ad ansa



80-461-13-04

Fig. 13

Drahtschlingenelektrode  
 Wire loop electrode  
 Electrodo de asa de alambre  
 Electrode anse  
 Elettrodo ad ansa



80-462-13-04

Fig. 13

Drahtschlingenelektrode  
 Wire loop electrode  
 Electrodo de asa de alambre  
 Electrode anse  
 Elettrodo ad ansa

Monopolare Elektroden für Dental und Kosmetik  
 Monopolar electrodes for dental and cosmetic applications  
 Electrodoes monopolaes para la medicina dental y cosmética  
 Electrodes monopolaires pour le secteur dentaire et cosmétique  
 Elettrodi monopolari per il settore dentale e cosmetico

Elektroden mit Ø 1,6 mm  
 Electrodes Ø 1.6 mm  
 Electrodoes con Ø 1,6 mm  
 Electrodes Ø 1,6 mm  
 Elettrodi Ø 1,6 mm

Drahtstärke der Drahtschlingenelektroden = Ø 0,2 mm  
 Wire size of wire loop electrodes = Ø 0.2 mm  
 Grosor del alambre del electrodo de asa = Ø 0,2 mm  
 Epaisseur du fil des électrodes anse = Ø 0,2 mm  
 Spessore filo degli elettrodi ad ansa = Ø 0,2 mm

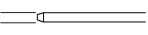
Ø 1,6 mm  max. 500 V<sub>p</sub>



80-461-14-04

Fig. 14

8,0 x 5,0 mm

Drahtschlingenelektrode, rhombusförmig  
 Wire loop electrode, rhombic  
 Electrodo de asa de alambre romboidal  
 Electrode anse, romboïdale  
 Elettrodo ad ansa a forma di rombo



80-461-15-04

Fig. 15

7,0 x 1,5 mm

Drahtschlingenelektrode, länglich, Schaft 45° abgewinkelt  
 Wire loop electrode, elongated, shaft 45° angled  
 Electrodo de asa de alambre oblonga, vástago acodado 45°  
 Electrode anse, forme allongée, tige coudée en 45°  
 Elettrodo ad ansa retta, asta curva a 45°



80-461-16-04

Fig. 16

7 mm

Hakenelektrode, 45° abgewinkelt  
 Hook electrode, 45° angled  
 Electrodo de gancho, vástago acodado 45°  
 Electrode crochet, tige coudée 45°  
 Elettrodo ad uncino, 7 mm, asta curva a 45°



80-461-17-04

Fig. 17

6,0 x 1,3 mm

Drahtschlingenelektrode, länglich, gerade  
 Wire loop electrode, elongated, straight  
 Electrodo de asa de alambre oblonga, recto  
 Electrode anse, forme allongée, droite  
 Elettrodo ad ansa retta



80-461-18-04

Fig. 18

7,0 x 1,7 mm

Drahtschlingenelektrode, länglich, 30° abgewinkelt  
 Wire loop electrode, elongated, 30° angled  
 Electrodo de asa de alambre oblonga, acodado 30°  
 Electrode anse, forme allongée, coudée en 30°  
 Elettrodo ad ansa curva, angolo 30°



80-461-19-04

Fig. 19

5,5 x 1,4 mm

Drahtschlingenelektrode, länglich, 90° abgewinkelt  
 Wire loop electrode, elongated, 90° angled  
 Electrodo de asa de alambre oblonga, acodado 90°  
 Electrode anse, forme allongée, coudée en 90°  
 Elettrodo ad ansa curva, angolo 90°



80-461-20-04

Fig. 20

7,0 x 1,4 mm

Drahtschlingenelektrode, länglich, 45° abgewinkelt  
 Wire loop electrode, elongated, 45° angled  
 Electrodo de asa de alambre oblonga, acodado 45°  
 Electrode anse, forme allongée, coudée en 45°  
 Elettrodo ad ansa curva, angolo 45°



80-461-21-04

Fig. 21

7,0 x 1,3 mm

Drahtschlingenelektrode, länglich, gerade  
 Wire loop electrode, elongated, straight  
 Electrodo de asa de alambre oblonga, recto  
 Electrode anse, forme allongée, droite  
 Elettrodo ad ansa retta

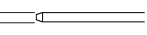

*Elektroden mit Ø 1,6 mm*  
*Electrodes Ø 1.6 mm*  
*Electrodos con Ø 1,6 mm*  
*Electrodes Ø 1,6 mm*  
*Elettrodi Ø 1,6 mm*

Ø 1,6 mm  **max. 500 V<sub>p</sub>**



80-461-23-04

Implantationselektrode, 45° abgewinkelt,  
 Implantatology electrode, 45° angled  
 Electrodo per implantologia, acodado 45°  
 Electrode pour implantologie, coudée en 45°  
 Elettrodo per implantologia, angolo 45°



80-461-22-04

Fig. 22  
 13,0 x 1,0 mm

Drahtschlingenelektrode, länglich, 45° abgewinkelt  
 Wire loop electrode, elongated, 45° angled  
 Electrodo de asa de alambre oblonga, acodado 45°  
 Electrode anse, forme allongée, coudée en 45°  
 Elettrodo ad ansa curva, angolo 45°

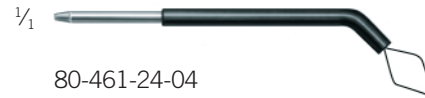

80-461-24-04

Fig. 24  
 8 x 5 mm

Drahtschlingenelektrode, rhombusförmig, Schaft 45° abgewinkelt  
 Wire loop electrode, rhombic, shaft 45° angled  
 Electrodo de asa de alambre romboidal, vástago acodado 45°  
 Electrode anse, rhomboïdale, tige coudée en 45°  
 Elettrodo ad ansa, forma di rombo, 8 x 5 mm, asta curva a 45°



80-461-31-04

Fig. 31  
 Ø 0,6 mm

Koagulations-Nadelelektrode, 45° abgewinkelt  
 Needle electrode for coagulation, 45° angled  
 Electrodo de aguja para la coagulación, acodado 45°  
 Electrode aiguille pour la coagulation, coudée en 45°  
 Elettrodo ad ago per coagulazione, asta curva a 45°



80-461-32-04

Fig. 32  
 Ø 1,7 mm

Koagulations-Nadelelektrode, 30° abgewinkelt  
 Needle electrode for coagulation, 30° angled  
 Electrodo de aguja para la coagulación, acodado 30°  
 Electrode aiguille pour la coagulation, coudée en 30°  
 Elettrodo ad ago per coagulazione, asta curva a 30°

Monopolare Elektroden für Dental und Kosmetik  
 Monopolar electrodes for dental and cosmetic applications  
 Electrodoes monopolaes para la medicina dental y cosmética  
 Electrodes monopolaires pour le secteur dentaire et cosmétique  
 Elettrodi monopolari per il settore dentale e cosmetico

Elektroden mit Ø 1,6 mm  
 Electrodes Ø 1.6 mm  
 Electrodoes con Ø 1,6 mm  
 Electrodes Ø 1,6 mm  
 Elettrodi Ø 1,6 mm

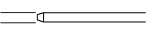
Ø 1,6 mm  max. 500 V<sub>p</sub>



80-461-33-04

Fig. 33

Kugelelektrode, 45° abgewinkelt  
 Ball electrode, 45° angled  
 Electrodo de bola, 45° acodado  
 Electrode boule, coudée en 45°  
 Elettrodo a sfera, asta curva a 45°



80-461-34-04

Fig. 34

Kugelelektrode, 45° abgewinkelt  
 Ball electrode, 45° angled  
 Electrodo de bola, 45° acodado  
 Electrode boule, coudée en 45°  
 Elettrodo a sfera, asta curva a 45°



80-461-35-04

Fig. 35

Koagulations-und Fulgurationselektrode, gerade  
 Coagulation and fulguration electrode, straight  
 Electrodo para la coagulación y la fulguración, recto  
 Electrode de coagulation et fulguration, droite  
 Elettrodo per folgorazione e coagulazione, retto



80-461-36-04

Fig. 36

Koagulations-und Fulgurationselektrode, 90° abgewinkelt  
 Coagulation and fulguration electrode, 90° angled  
 Electrodo para la coagulación y la fulguración, acodado 90°  
 Electrode de coagulation et fulguration, coudée en 90°  
 Elettrodo per folgorazione e coagulazione, angolo 90°



80-461-37-04

Nadelelektrode, 45° abgewinkelt  
 Needle electrode, 45° angled  
 Electrodo de aguja, acodado 45°  
 Electrode aiguille, coudée en 45°  
 Elettrodo ad ago, angolo 45°



80-530-03-04

Elektrode für Besenreiser  
 Electrode for varices/spider-bursts  
 Electrodo para verrugas  
 Electrode pour varices  
 Elettrodo per varici



80-530-04-04

Couperosa-Elektrode  
 Electrode for rosacea/telangiectasias  
 Electrodo para couperose  
 Electrode pour couperose  
 Elettrodo per couperosa



80-530-06-04

Z-Elektrode  
 Z-electrode  
 Electrodo Z  
 Electrode en Z  
 Elettrodo a Z





**Elektroden mit Ø 0,8 mm**  
**Electrodes Ø 0.8 mm**  
**Electrodos con Ø 0,8 mm**  
**Electrodes Ø 0,8 mm**  
**Elettrodi Ø 0,8 mm**

Ø 0,8 mm 

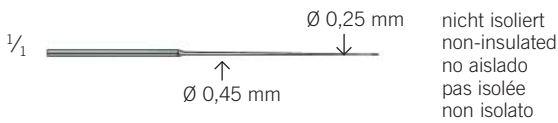

80-525-04-04  
 Nadelelektrode, 1 Dutzend  
 Needle electrode, 1 dozen  
 Electrodo de aguja, 1 docena  
 Electrode aiguille, 1 douzaine  
 Elettrodo ad ago, 1 dozzina



80-530-01-04 **max. 250 V<sub>p</sub>**  
 Epilationsnadel, isoliert, 1 Stück  
 Epilation needle, insulated, 1 piece  
 Aguja de depilación, aislada, 1 unidad  
 Aiguille dépilation, isolée, 1 pièce  
 Ago per depilazione, isolato, 1 pezzo



80-530-02-04 **max. 250 V<sub>p</sub>**  
 Couperosa-Elektrode, 45° abgewinkelt  
 Electrode for rosacea/telangiectasias, 45° angled  
 Electrodo para couperosa, acodado 45°  
 Electrode pour couperose, coudée 45°  
 Elettrodo per cuperosa, angolo 45°

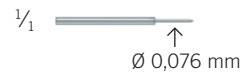

80-530-05-04 **STERILE IR**  
 Epilationselektrode, K3S short, Schaft 0.8 mm, 50/Pck.  
 Epilation electrode, K3S short, shaft 0.8 mm, 50/pack  
 Electrodo de depilación, K3S short, vástago de 0,8 mm, 50/unid.  
 Electrode dépilation, K3S short, tige de 0,8 mm, 50/unité  
 Elettrodo per depilazione, K3S short, asta di 0,8 mm, 50/unità

**Aktivelektroden mit Ø 4 mm**  
**Active electrodes Ø 4 mm**  
**Electrodos activos con Ø 4 mm**  
**Electrodes actives Ø 4 mm**  
**Elettrodi attivi Ø 4 mm**

Ø 4 mm 

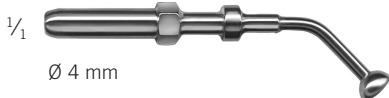

80-563-05-04  
 Faltenglättungselektrode, passend in Handgriff 80-217-01-04  
 Wrinkle smoothing electrode, for electrode handle 80-217-01-04  
 Electrodo antiarrugas, para mango porta-electrodos 80-217-01-04  
 Electrode pour lisser des rides, pour manche 80-217-01-04  
 Elettrodo per rughe, utilizzabile con il manipo 80-217-01-04

Elektroden-Adapter für monopolare Handgriffe  
 Electrode adapter for monopolar handles  
 Adaptador de electrodos para mangos monopolares  
 Adaptateur pour manches monopolaires  
 Adattatore elettrodo per manipoli monopolari

*Elektrodenfixierung über Schraubkappe*  
*Electrode fixation with screw cap*  
*Fijación de electrodos con tapa roscada*  
*Fixation de l'électrode à l'aide du bouchon à vis*  
*Fissaggio elettrodo tramite tappo a vite*



80-460-04-04 **max. 3700 V<sub>p</sub>**

Adapter von Ø 4 mm auf Ø 1,6 mm, z.B. Dental-Elektroden  
 Adapter from Ø 4 mm to Ø 1.6 mm, e.g. for dental electrodes  
 Adaptador de Ø 4 mm a Ø 1,6 mm, p.e. para electrodos dentales  
 Adaptateur de Ø 4 mm à Ø 1,6 mm, p.e. pour électrodes dentaires  
 Adattatore da Ø 4 mm a Ø 1,6 mm, p.e. per elettrodi dentali



80-531-00-04 **max. 3700 V<sub>p</sub>**

Adapter von Ø 4 mm auf Ø 3/8" = 2,4 mm  
 Adapter from Ø 4 mm to Ø 3/8" = 2.4 mm  
 Adaptador de Ø 4 mm a Ø 3/8" = 2,4 mm  
 Adaptateur de Ø 4 mm à Ø 3/8" = 2,4 mm  
 Adattatore da Ø 4 mm a Ø 3/8" = 2,4 mm



80-532-00-04 **max. 3700 V<sub>p</sub>**

Adapter von Ø 4 mm auf Ø 0,8 mm für 80-525-04-04/80-536-04-04  
 Adapter from Ø 4 mm to Ø 0.8 mm for 80-525-04-04/80-536-04-04  
 Adaptador de Ø 4 mm a Ø 0,8 mm para 80-525-04-04/80-536-04-04  
 Adaptateur de Ø 4 mm à Ø 0,8 mm pour 80-525-04-04/80-536-04-04  
 Adattatore da Ø 4 mm a Ø 0,8 mm per 80-525-04-04/80-536-04-04



80-533-00-04 **max. 50 V<sub>p</sub>**

Adapter von Ø 1,6 mm auf Ø 0,8 mm für 80-525-04-04/80-536-04-04  
 Adapter from Ø 1.6 mm to Ø 0.8 mm for 80-525-04-04/80-536-04-04  
 Adaptador de Ø 1,6 mm a Ø 0,8 mm para 80-525-04-04/80-536-04-04  
 Adaptateur de Ø 1,6 mm à Ø 0,8 mm pour 80-525-04-04/80-536-04-04  
 Adattatore da Ø 1,6 mm a Ø 0,8 mm per 80-525-04-04/80-536-04-04

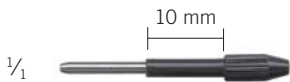

80-533-01-04 **max. 50 V<sub>p</sub>**

Adapter von Ø 1,6 mm auf Ø 0,8 mm für 80-525-04-04/80-536-04-04  
 Adapter from Ø 1.6 mm to Ø 0.8 mm for 80-525-04-04/80-536-04-04  
 Adaptador de Ø 1,6 mm a Ø 0,8 mm para 80-525-04-04/80-536-04-04  
 Adaptateur de Ø 1,6 mm à Ø 0,8 mm pour 80-525-04-04/80-536-04-04  
 Adattatore da Ø 1,6 mm a Ø 0,8 mm per 80-525-04-04/80-536-04-04

Elektrodenbehälter  
Containers for electrodes  
Contenedores para electrodos  
Boîtes pour électrodes  
Contenitori per elettrodi

Monopolare Elektroden  
Monopolar electrodes  
Electrodos monopolares  
Electrodes monopolaires  
Elettrodi monopolari



80-408-00-01\*

für 8 Elektroden mit Schaft Ø 4 mm  
for 8 electrodes with shaft Ø 4 mm  
para 8 electrodos con vástago de Ø de 4 mm  
pour 8 électrodes à tige de Ø 4 mm  
per 8 elettrodi con asta di Ø 4 mm



80-444-08-01\*

für 8 Elektroden mit Schaft Ø 1,6 mm  
for 8 electrodes with shaft Ø 1,6 mm  
para 8 electrodos con vástago de Ø de 1,6 mm  
pour 8 électrodes à tige de Ø 1,6 mm  
per 8 elettrodi con asta di Ø 1,6 mm



80-416-00-01\*

für 16 Elektroden mit Schaft Ø 4 mm  
for 16 electrodes with shaft Ø 4 mm  
para 16 electrodos con vástago de Ø de 4 mm  
pour 16 électrodes à tige de Ø 4 mm  
per 16 elettrodi con asta di Ø 4 mm

\* Autoklavierbar bei 134 °C  
Autoclavable at 134°C  
Autoclavable a 134 °C  
Peut passer à l'autoclave à 134 °C  
Autoclavabile a 134 °C

Isolit-Pinzetten  
 Monopolar electrodes  
 Isolit forceps  
 Pinzas Isolit  
 Pincas Isolit



80-285-40-04 80-285-50-04 **max. 4000 V<sub>p</sub>**  
 4 m/13 ft. 5 m/16 ft.

Anschlusskabel für Isolit-Pinzetten und Zubehör aus unserem früheren Geräteprogramm

Connection cable for Isolit forceps and older KLS Martin instruments (former product line)

Cable de conexión para pinzas Isolit e instrumentos de nuestra anterior gama de equipos

Câble de raccordement pour des pincas Isolit et pour des instruments de notre ancien programme d'appareils

Cavo di connessione per pinze Isolit e strumenti del nostro precedente programma degli apparecchi



80-285-55-04 **max. 4000 V<sub>p</sub>**  
 4 m/13 ft.

Anschlusskabel für Isolit-Pinzetten, mit 3-Pin-Stecker

Connecting cable for Isolit forceps, with 3-pin plug

Cable de conexión para pinzas Isolit, con clavija de tres patillas

Câble de raccordement pour pincas Isolit, avec fiche à 3 broches

Cavo di collegamento per pinzette Isolit, con spina a 3 pin



83-124-52-04 **max. 4000 V<sub>p</sub>**  
 4 m/13 ft.

maxium® „i“-Version, ME MB 3 „i“, ME MB 2 „i“ und Valleylab-Geräte → für Isolit-Pinzetten

maxium® „i“-version, ME MB 3 „i“, ME MB 2 „i“ and Valleylab units → for Isolit forceps

maxium® versión „i“, ME MB 3 „i“, ME MB 2 „i“ y aparatos Valleylab → para pinzas Isolit

maxium® version «i», ME MB 3 «i», ME MB 2 «i» et appareils Valleylab → pour des pincas Isolit

maxium® versione „i“, ME MB 2 „i“, ME MB 2 „i“ e apparecchi Valleylab → per pinze Isolit

**max. 500 V<sub>p</sub>**



Kontaktbereich zur monopolaren Klemmenkoagulation

Contact area for monopolar forceps coagulation

Área de contacto para la coagulación monopolar con pinzas

Zone de contact pour coagulation par pince monopolaire

Zona di contatto per la coagulazione con pinza monopolare

1/2

1/2

80-900-18-03 = 18 cm/7"  
 80-900-21-03 = 21 cm/8 1/4"  
 80-900-25-03 = 25 cm/10"

ohne Buchse  
 without socket  
 sin conexión  
 sans prise  
 senza presa

80-902-18-03 = 18 cm/7"  
 80-902-21-03 = 21 cm/8 1/4"  
 80-902-25-03 = 25 cm/10"

mit Buchse  
 with socket  
 con conexión  
 avec prise  
 con presa

Monopolare Elektroden für die MIC  
 Monopolar electrodes for MIS  
 Electrodoos monopolaes para la cirugía endoscópica  
 Electrodes monopolaires pour la chirurgie non-invasive  
 Elettrodi monopolari per la chirurgia mininvasiva

Monopolare Elektroden  
 Monopolar electrodes  
 Electrodoos monopolaes  
 Electrodes monopolaires  
 Elettrodi monopolari



1/1



1/3

83-120-50-04 **max. 4000 V<sub>p</sub>**  
 5 m/16 ft.

Anschlusskabel für 83-520-39-04  
 Connection cable for 83-520-39-04  
 Cable de conexión para 83-520-39-04  
 Câble de raccordement pour 83-520-39-04  
 Cavo di connessione per 83-520-39-04



1/3

83-120-51-04 **max. 4000 V<sub>p</sub>**  
 5 m/16 ft.

Anschlusskabel für 83-520-39-04  
 Connection cable for 83-520-39-04  
 Cable de conexión para 83-520-39-04  
 Câble de raccordement pour 83-520-39-04  
 Cavo di connessione per 83-520-39-04



1/2

83-520-39-04 **max. 1500 V<sub>p</sub>**  
 47 cm/18 1/2"

Hakenelektrode, Ø 5 mm, isoliert,  
 Hakenlänge 5 mm

Hook electrode, Ø 5 mm, insulated,  
 hook length 5 mm

Electrodo de gancho, Ø 5 mm, aislado, lon-  
 gitud del gancho 5 mm

Electrode crochet, Ø 5 mm, isolée,  
 longueur du crochet de 5 mm

Elettrodo ad uncino, Ø 5 mm, isolato,  
 lunghezza del gancio 5 mm





WIEDERVERWENDBARE NEUTRALELEKTRODEN  
REUSABLE NEUTRAL ELECTRODES  
PLACAS NEUTRAS REUTILIZABLES  
ELECTRODES NEUTRES REUTILISABLES  
ELETTRODI NEUTRI RIUTILIZZABILI

EINMAL-NEUTRALELEKTRODEN  
DISPOSABLE NEUTRAL ELECTRODES  
PLACAS NEUTRAS DESECHABLES  
ELECTRODES NEUTRES A USAGE UNIQUE  
ELETTRODI NEUTRI MONOUSO

37-42



*mit 6,3-mm-NE-Stecker  
with 6.3-mm NE plug  
con clavija de PN de 6,3 mm  
avec fiche EN de 6,3 mm  
con spina EN da 6,3 mm*



*mit US-NE-Stecker  
with US NE plug  
con clavija de PN tipo US  
avec fiche EN US  
con spina EN US*

80-342-03-04

4 m/13 ft.

15 x 26 cm

Gummi-Neutralelektrode für Erwachsene,  
ungeteilte Kontaktfläche 370 cm<sup>2</sup>

Rubber neutral electrode for adults,  
single contact surface 370 cm<sup>2</sup>

Placa neutra de goma para adultos,  
superficie de contacto no dividida de 370 cm<sup>2</sup>

Electrode neutre en caoutchouc pour adultes,  
surface de contact non divisée de 370 cm<sup>2</sup>

Elettrodo neutro di gomma per adulti,  
superficie integrale di contatto da 370 cm<sup>2</sup>

80-342-04-04

4 m/13 ft.

15 x 26 cm

Gummi-Neutralelektrode für Erwachsene,  
ungeteilte Kontaktfläche 370 cm<sup>2</sup>

Rubber neutral electrode for adults,  
single contact surface 370 cm<sup>2</sup>

Placa neutra de goma para adultos,  
superficie de contacto no dividida de 370 cm<sup>2</sup>

Electrode neutre en caoutchouc pour adultes,  
surface de contact non divisée de 370 cm<sup>2</sup>

Elettrodo neutro di gomma per adulti,  
superficie integrale di contatto da 370 cm<sup>2</sup>

80-332-03-04

4 m/13 ft.

8 x 16 cm

Gummi-Neutralelektrode für Kinder,  
ungeteilte Kontaktfläche 120 cm<sup>2</sup>

Rubber neutral electrode for children,  
single contact surface 120 cm<sup>2</sup>

Placa neutra de goma para niños,  
superficie de contacto no dividida de 120 cm<sup>2</sup>

Electrode neutre en caoutchouc pour enfants,  
surface de contact non divisée de 120 cm<sup>2</sup>

Elettrodo neutro di gomma per bambini,  
superficie integrale di contatto da 120 cm<sup>2</sup>

80-342-05-04

4 m/13 ft.

8 x 16 cm

Gummi-Neutralelektrode für Kinder,  
ungeteilte Kontaktfläche 120 cm<sup>2</sup>

Rubber neutral electrode for children,  
single contact surface 120 cm<sup>2</sup>

Placa neutra de goma para niños,  
superficie de contacto no dividida de 120 cm<sup>2</sup>

Electrode neutre en caoutchouc pour enfants,  
surface de contact non divisée de 120 cm<sup>2</sup>

Elettrodo neutro di gomma per bambini,  
superficie integrale di contatto da 120 cm<sup>2</sup>



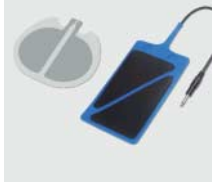

*mit 6,3-mm-NE-Stecker  
with 6.3-mm NE plug  
con clavija de PN de 6,3 mm  
avec fiche EN de 6,3 mm  
con spina EN da 6,3 mm*



80-342-06-04

4 m/13 ft.

15 x 26 cm

Twin-Pad-Zweiflächen-Neutralelektrode, ohne Knöpfe, Kontaktfläche 256 cm<sup>2</sup>, (2 x 80-371-02-04 + 1 x 80-370-50-04/ 80-371-00-04 erforderlich)

Twin-Pad neutral electrode with two contact surfaces (split), without buttons, contact surface 256 cm<sup>2</sup>, (2 x 80-371-02-04 + 1 x 80-370-50-04 /80-371-00-04 required)

Placa neutra Twin-Pad con dos superficies, sin botones, superficie de contacto de 256 cm<sup>2</sup>, (preciso 2 x 80-371-02-04 + 1 x 80-370-50-04 /80-371-00-04)

Twin-Pad électrode neutre double, réutilisable, sans boutons, surface de contact 256 cm<sup>2</sup>, (nécessite 2 x 80-371-02-04 + 1 x 80-370-50-04 /80-371-00-04)

Twin-Pad piastra neutra con due superfici, senza bottoni, superficie di contatto da 256 cm<sup>2</sup>, (necessario 2 x 80-371-02-04 + 1 x 80-370-50-04/80-371-00-04)

**Hinweis:**

Diese Neutralelektrode darf nicht mit den HF-Generatoren maxium®, Minicutter, ME 102 und MD 62 eingesetzt werden!

**Notice:**

This neutral electrode must not be used with the maxium®, Minicutter, ME 102 and MD 62 HF generators!

**Indicación:**

¡Esta placa neutra no debe utilizarse con el generadores de AF maxium®, Minicutter, ME 102 y MD 62!

**Indication:**

Défense d'utiliser cette électrode neutre avec le générateurs HF maxium®, Minicutter, ME 102 et MD 62!

**Avvertenza:**

questo elettrodo neutro non può essere usato con il generatori AF maxium®, Minicutter, ME 102 e MD 62!

80-371-02-04

Knopf für KLS Martin Twin-Pad 80-342-06-04  
Button for KLS Martin Twin-Pad 80-342-06-04  
Botón para la KLS Martin Twin-Pad 80-342-06-04  
Bouton pour KLS Martin Twin-Pad 80-342-06-04  
Bottone per KLS Martin Twin-Pad 80-342-06-04

Wiederverwendbare Neutralelektroden  
Reusable neutral electrodes  
Placas neutras reutilizables  
Electrodes neutres réutilisables  
Elettrodi neutri riutilizzabili



*mit 6,3-mm-NE-Stecker  
with 6.3-mm NE plug  
con clavija de PN de 6,3 mm  
avec fiche EN de 6,3 mm  
con spina EN da 6,3 mm*

*nur zur Verwendung mit Geräten mit einer  
max. Ausgangsleistung von 50 W zugelassen (z. B. MD 62)!*

*only approved for use with units having a  
max. output of 50 W (e.g. MD 62)!*

*¡solo aprobadas para la utilización con aparatos con una  
potencia de salida máx. de 50 W (p. ej. MD 62)!*

*autorisées uniquement pour utilisation avec des appareils  
dont la puissance de sortie maximale est de 50 W (par ex. MD62) !*

*utilizzo ammesso soltanto con apparecchi con  
potenza max. d'uscita di 50 W (ad es. MD 62)!*

80-310-04-04

Handzylinder-Neutralelektrode mit 4 m Kabel

Hand cylinder neutral electrode with connection  
cable of 4 m

Placa neutra en forma de cilindro con cable  
de conexión de 4 m

Electrode neutre en forme de cylindre avec  
câble de raccordement de 4 m

Elettrodo neutro a forma cilindrica con cavo  
di connessione da 4 m



80-370-50-04 = 50 cm/20"

80-371-00-04 = 100 cm/40"

Gummibinden, gelocht  
Rubber bands, with holes  
Cintas de goma, perforadas  
Bandes caoutchouc, perforées  
Nastri in gomma, con fori



80-371-01-04

Knopf für Gummibinde 80-370-50-04 + 80-371-00-04  
Button for rubber band 80-370-50-04 + 80-371-00-04  
Botón para la cinta de goma 80-370-50-04 + 80-371-00-04  
Bouton pour bande caoutchouc 80-370-50-04 + 80-371-00-04  
Bottone per nastro in gomma 80-370-50-04 + 80-371-00-04



80-372-00-04

Textilband mit Klettverschluss, 90 cm, waschbar bei 60 °C  
Textile band with velcro strap, 90 cm, washable at 60°C  
Tira auto-adhesiva, 90 cm, lavable a 60 °C  
Bande auto-adhésive, 90 cm, lavable à 60 °C  
Nastro in velcro, 90 cm, lavabile a 60 °C

## Einmal-Neutralelektroden

Disposable neutral electrodes  
Placas neutras desechables  
Electrodes neutres à usage unique  
Elettrodi neutri monouso

Neutralelektroden  
Neutral electrodes  
Placas neutras  
Electrodes neutres  
Elettrodi neutri

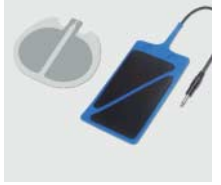

80-294-40-04  
4 m/13 ft.  
KLS Martin



80-294-43-04  
4 m/13 ft.  
**maxium** „e“-Version  
Erbe



80-294-44-04  
5 m/16 ft.  
**maxium** „i“-Version  
ME MB 3 „i“-Version,  
ME MB 2 „i“-Version, Valleylab

Anschlusskabel für Einmal-Neutralelektroden  
Connection cable for disposable neutral electrodes

Cable de conexión para placas neutras desechables

Câble de raccordement pour électrodes neutres à usage unique

Cavo di connessione per elettrodi neutri monouso

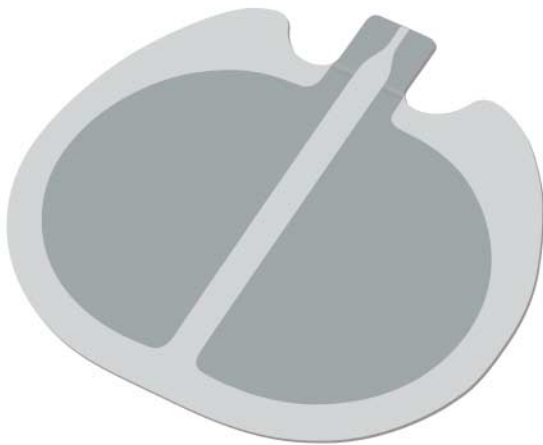

80-344-09-04

PCS-DuoSafe-Einmal-Neutralelektrode für Erwachsene und Kinder, geteilte Kontaktfläche 107 cm<sup>2</sup>, ohne Anschlusskabel, 50 Stück/VE

PCS DuoSafe disposable neutral electrode for adults and children, split contact surface 107 cm<sup>2</sup>, without connection cable, 50/pack

Placa neutra desechable tipo PCS DuoSafe con dos partes separadas 107 cm<sup>2</sup> para adultos y niños, sin cable de conexión, 50 piezas/unidad

Electrode neutre à usage unique type PCS DuoSafe avec deux surfaces de contact séparées 107 cm<sup>2</sup> pour adultes et enfants, sans câble de raccordement, 50 pièces/unité

Elettrodo neutro monouso tipo PCS DuoSafe con due superfici separate 107 cm<sup>2</sup> per adulti e bambini, senza cavo di connessione, 50 pezzi/unità

Einmal-Neutralelektroden  
 Disposable neutral electrodes  
 Placas neutras desechables  
 Electrodes neutres à usage unique  
 Elettrodi neutri monouso



maxium® **Baby**

80-344-12-04

PCS DuoSafe Einmal-Neutralelektrode für Neugeborene und Babies bis max. 5,0 kg Körpergewicht, geteilte Kontaktfläche 33 cm<sup>2</sup>, mit Anschlusskabel International, 10 Stück/VE

PCS DuoSafe disposable neutral electrode for newborns and babies up to a maximum weight of 5.0 kg, split contact surface, 33 cm<sup>2</sup>, with international connecting cable, 10 items/pack

PCS DuoSafe placa neutra desechable para neonatos y bebés hasta un peso máximo de 5,0 kg, superficie de contacto dividida de 33 cm<sup>2</sup>, con cable de conexión internacional, 10 unidades/envase

PCS DuoSafe Électrode neutre à usage unique pour nouveau-nés et bébés dont le poids max. est de 5,0 kg, surface de contact divisée 33 cm<sup>2</sup>, avec câble de raccordement international, 10 pièces/unité

Elettrodo neutro monouso PCS DuoSafe per neonati e bebè fino ad un peso massimo di 5,0 kg, superficie di contatto separata di 33 cm<sup>2</sup>, con cavo di collegamento internazionale, 10 unità/UV

Diese Neutralelektrode darf nur mit dem HF-Gerät **maxium**® (Typ ME 402) ab Hardwarestand 06 sowie Softwarestand größer V 3.404 verwendet werden! Es ist ist der dafür vorgesehene Baby-NE-Modus zu wählen!

This neutral electrode may only be used with the **maxium**® HF generator (type ME 402) from hardware status 06 and software status higher than V 3.404! The Baby NE mode intended for this neutral electrode must be selected in this case!

¡Esta placa neutra sólo debe utilizarse con el equipo de AF **maxium**® (tipo ME 402) a partir del estado de hardware 06 y con estado de software superior a V 3.404! ¡En todo caso deberá seleccionarse el modo de PN para bebé previsto!

Cette électrode neutre ne peut être utilisée qu'avec l'appareil HF **maxium**® (type ME 402), à partir des versions matérielle HW06 et logicielle supérieure à V3.404 ! Il faut sélectionner le mode EN Bébé prévu à cet effet !

Questo elettrodo neutro può essere usato solo con l'apparecchio AF **maxium**® (tipo ME 402) a partire dalla versione hardware 06 e dalla versione software superiore a V 3.404! In questo caso occorre selezionare la modalità speciale EN per bebè prevista allo scopo!

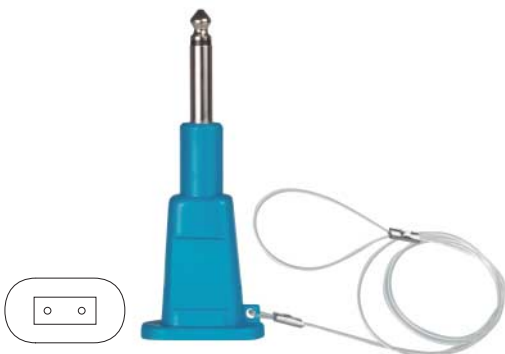

80-344-11-04 **max. 500 V<sub>p</sub>**

Adapter mit internationaler NE-Buchse und 6,3-mm-Stecker  
 Adapter with international NE socket and 6.3-mm plug  
 Adaptador con hembra de PN internacional y clavija de 6,3 mm  
 Adaptateur avec fiche EN internationale et fiche 6,3 mm  
 Adattatore con presa EN internazionale e spina da 6,3 mm



BIPOLARES INSTRUMENTARIUM  
BIPOLAR INSTRUMENTS  
INSTRUMENTOS BIPOLARES  
INSTRUMENTS BIPOLAIRES  
STRUMENTI BIPOLARI

43-69





80-287-33-04 80-287-53-04  
 3 m/10 ft. 5 m/16 ft.

KLS-Martin- und Berchtold-Geräte  
 → bipolare Instrumente

KLS Martin and Berchtold units  
 → bipolar instruments

aparatos KLS Martin y Berchtold  
 → instrumentos bipolares

appareils KLS Martin et Berchtold  
 → instruments bipolaires

apparecchi KLS Martin e Berchtold  
 → strumenti bipolari



80-286-30-04 80-286-50-04  
 3 m/10 ft. 5 m/16 ft.

maxium® „e“-Version/Erbe-Geräte ICC und ACC/VIO  
 → bipolare Instrumente

maxium® "e"-Version/ICC and ACC/VIO Erbe units  
 → bipolar instruments

maxium® versión "e"/aparatos Erbe ICC e ACC/VIO  
 → instrumentos bipolares

maxium® version «e»/appareils Erbe ICC et ACC/VIO  
 → instruments bipolaires

maxium® versione "e"/apparecchi Erbe ICC e ACC/VIO  
 → strumenti bipolari



80-287-89-04 80-287-90-04  
 3 m/10 ft. 5 m/16 ft.

maxium® „i“-Version, ME MB 3 „i“-Version, ME MB 2  
 „i“-Version /Valleylab-Geräte → bipolare Instrumente

maxium® "i"-Version/ME MB 3 "i"-Version, ME MB 2  
 "i"-Version/Valleylab units → bipolar instruments

maxium® versión "i"/ME MB 3 versión "i"/ ME MB 2  
 versión "i"/aparatos Valleylab → instrumentos bipolares

maxium® version «i», ME MB 3 version «i», ME MB 2  
 version «i»/appareils Valleylab → instruments bipolaires

maxium® versione "i", ME MB 3 versione "i"/ ME MB 2  
 versione "i"/apparecchi Valleylab → strumenti bipolari

**Standard-Version** max. 300 Vp  
**Standard version**  
**Versión estándar**  
**Version standard**  
**Versione standard**



80-570-18-04  
 marCut® Standard  
 18 cm/7"



80-570-21-04  
 marCut® Standard  
 21 cm/8 1/4"



80-570-23-04  
 marCut® Standard  
 23 cm/9"



80-570-28-04  
 marCut® Standard  
 28 cm/11"



$\frac{1}{3}$  max. 600 V<sub>p</sub>

80-287-72-04  
 5 m/16 ft.

Codman- und Valleylab-Geräte  
 → bipolare Instrumente

Codman and Valleylab units  
 → bipolar instruments

aparatos Codman y Valleylab  
 → instrumentos bipolares

appareils Codman et Valleylab  
 → instruments bipolaires

apparecchi Codman e Valleylab  
 → strumenti bipolari



80-570-00-04

Protector für die Aufbereitung. Wir empfehlen die Verwendung des Protectors für die Aufbereitung der Schere.

Protector for instrument processing. We recommend using the protector for processing the scissors.

Protector para el tratamiento. Recomendamos la utilización del protector para el tratamiento de las tijeras.

Protecteur pour la préparation. Nous recommandons l'utilisation du protecteur pour la préparation des ciseaux.

Protettore per il trattamento. Si consiglia l'uso del protettore per il trattamento delle forbici.



Weitere Informationen entnehmen Sie bitte der separaten Broschüre.

For further information please refer to our separate product brochure.

Encontrará informaciones adicionales en el folleto individual.

Vous trouverez des informations supplémentaires dans la brochure.

Per ulteriori informazioni vedasi il prospetto separato.

## Slim Line

Schlanke Version max. 300 V<sub>p</sub>

Slim model

Versión delgada

Version élancée

Modello sottile



80-571-18-04  
 marCut® SL  
 18 cm/7"



80-571-21-04  
 marCut® SL  
 21 cm/8 1/4"



80-571-23-04  
 marCut® SL  
 23 cm/9"



80-571-28-04  
 marCut® SL  
 28 cm/11"



80-287-33-04 80-287-53-04  
 3 m/10 ft. 5 m/16 ft.

KLS-Martin- und Berchtold-Geräte  
 → bipolare Instrumente

KLS Martin and Berchtold units  
 → bipolar instruments

aparatos KLS Martin y Berchtold  
 → instrumentos bipolares

appareils KLS Martin et Berchtold  
 → instruments bipolaires

apparecchi KLS Martin e Berchtold  
 → strumenti bipolari



80-286-30-04 80-286-50-04  
 3 m/10 ft. 5 m/16 ft.

maxium® „e“-Version/Erbe-Geräte ICC und ACC/VIO  
 → bipolare Instrumente

maxium® "e"-Version/ICC and ACC/VIO Erbe units  
 → bipolar instruments

maxium® versión "e"/aparatos Erbe ICC e ACC/VIO  
 → instrumentos bipolares

maxium® version «e»/appareils Erbe ICC et ACC/VIO  
 → instruments bipolaires

maxium® versione "e"/apparecchi Erbe ICC e ACC/VIO  
 → strumenti bipolari



80-287-89-04 80-287-90-04  
 3 m/10 ft. 5 m/16 ft.

maxium® „i“-Version, ME MB 3 „i“-Version, ME MB 2  
 „i“-Version / Valleylab-Geräte → bipolare Instrumente

maxium® "i"-Version/ME MB 3 "i"-Version, ME MB 2  
 "i"-Version/Valleylab units → bipolar instruments

maxium® versión "i"/ME MB 3 versión "i"/ ME MB 2  
 versión "i"/aparatos Valleylab → instrumentos bipolares

maxium® version «i», ME MB 3 version «i», ME MB 2  
 version «i»/appareils Valleylab → instruments bipolaires

maxium® versione "i", ME MB 3 versione "i"/ ME MB 2  
 versione "i"/apparecchi Valleylab → strumenti bipolari

## Super Slim Line

Superschlanke Version  
 Super slim model  
 Versión super delgada  
 Version super mince  
 Versione extra snella

max. 300 Vp



80-572-13-04  
 marCut® SSL  
 13 cm / 5 1/8"

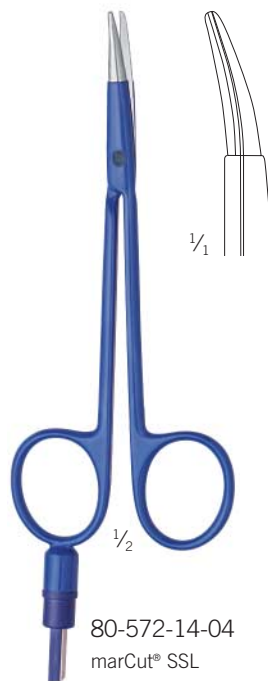

80-572-14-04  
 marCut® SSL  
 14 cm / 5 5/8"



80-572-17-04  
 marCut® SSL  
 17 cm / 6 5/8"





80-287-72-04  
 5 m/16 ft.

Codman- und Valleylab-Geräte  
 → bipolare Instrumente  
 Codman and Valleylab units  
 → bipolar instruments  
 aparatos Codman y Valleylab  
 → instrumentos bipolares  
 appareils Codman et Valleylab  
 → instruments bipolaires  
 apparecchi Codman e Valleylab  
 → strumenti bipolari



80-570-00-04

Protector für die Aufbereitung. Wir empfehlen die Verwendung des Protectors für die Aufbereitung der Schere.  
 Protector for instrument processing. We recommend using the protector for processing the scissors.  
 Protector para el tratamiento. Recomendamos la utilización del protector para el tratamiento de las tijeras.  
 Protecteur pour la préparation. Nous recommandons l'utilisation du protecteur pour la préparation des ciseaux.  
 Protettore per il trattamento. Si consiglia l'uso del protettore per il trattamento delle forbici.



Weitere Informationen entnehmen Sie bitte der separaten Broschüre.  
 For further information please refer to our separate product brochure.  
 Encontrará informaciones adicionales en el folleto individual.  
 Vous trouverez des informations supplémentaires dans la brochure.  
 Per ulteriori informazioni vedasi il prospetto separato.



mit geradem Stecker  
 with straight plug  
 con clavija recta  
 avec fiche droite  
 con spina diritta



Weitere Informationen entnehmen Sie bitte der separaten Broschüre.  
 For further information please refer to our separate product brochure.  
 Encontrará informaciones adicionales en el folleto individual.  
 Vous trouverez des informations supplémentaires dans la brochure.  
 Per ulteriori informazioni vedasi il prospetto separato.

Bipolare Pinzetten  
 Bipolar forceps  
 Pinzas bipolares  
 Pincers bipolaires  
 Pinze bipolari

max. 500 V<sub>p</sub>

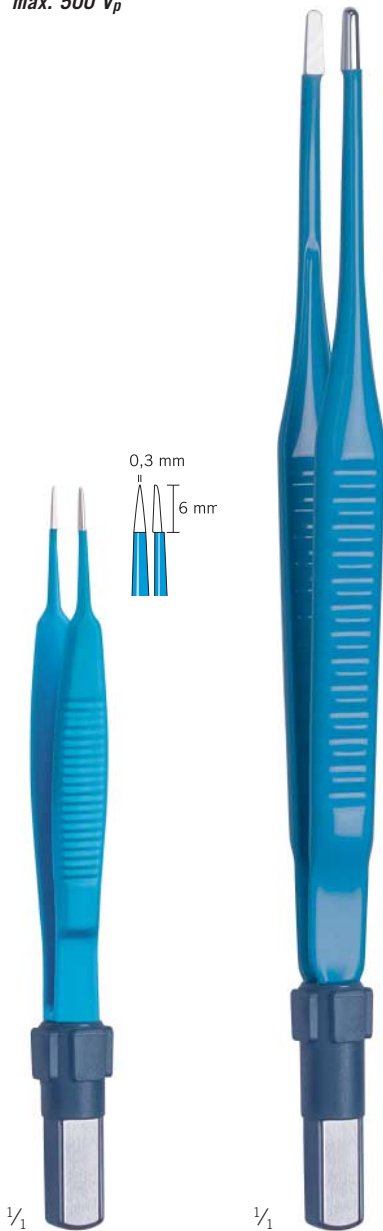

80-910-07-04  
 8,5 cm/3 1/4"  
 spitz, 0,3 mm  
 pointed, 0,3 mm  
 puntiaguda, 0,3 mm  
 pointue, 0,3 mm  
 acuta, 0,3 mm

Beispielabbildung  
 Example illustration  
 Ilustración a modo  
 de ejemplo  
 Illustration à titre  
 d'exemple  
 Figura di esempio

Bipolare Pinzetten, gerade  
 Bipolar forceps, straight  
 Pinzas bipolares, rectas  
 Pincers bipolaires, droites  
 Pinze bipolari, diritte

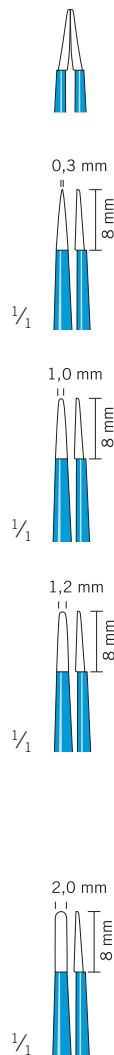

Spitzenbreite Tip width Ancho de la punta Largeur des pointes Larghezza delle punte	Länge Length Longitud Longueur Lunghezza	Artikel-Nr. Item No. N.º referencia Référence Codice articolo
---	--	---

**spitz/pointed/puntiaguda/pointue/acuta**

0,3 mm	12 cm/4 3/4"	80-910-12-04
0,3 mm	16 cm/6 1/4"	80-910-16-04
0,3 mm	18 cm/7"	80-910-18-04
0,3 mm	20 cm/8"	80-910-20-04
0,3 mm	22 cm/8 3/4"	80-910-22-04

**stumpf/blunt/roma/mousse/smuša**

1,0 mm	12 cm/4 3/4"	80-924-12-04
--------	--------------	--------------

**stumpf/blunt/roma/mousse/smuša**

1,2 mm	16 cm/6 1/4"	80-924-16-04
1,2 mm	18 cm/7"	80-924-18-04
1,2 mm	20 cm/8"	80-924-20-04
1,2 mm	22 cm/8 3/4"	80-924-22-04
1,2 mm	24 cm/9 1/2"	80-924-24-04
1,2 mm	26 cm/10 1/4"	80-924-26-04
1,2 mm	30 cm/11 3/4"	80-924-30-04

**stumpf/blunt/roma/mousse/smuša**

2,0 mm	12 cm/4 3/4"	80-934-12-04
2,0 mm	16 cm/6 1/4"	80-934-16-04
2,0 mm	18 cm/7"	80-934-18-04
2,0 mm	20 cm/8"	80-934-20-04
2,0 mm	22 cm/8 3/4"	80-934-22-04
2,0 mm	24 cm/9 1/2"	80-934-24-04
2,0 mm	26 cm/10 1/4"	80-934-26-04
2,0 mm	30 cm/11 3/4"	80-934-30-04



max. 500 V<sub>p</sub>

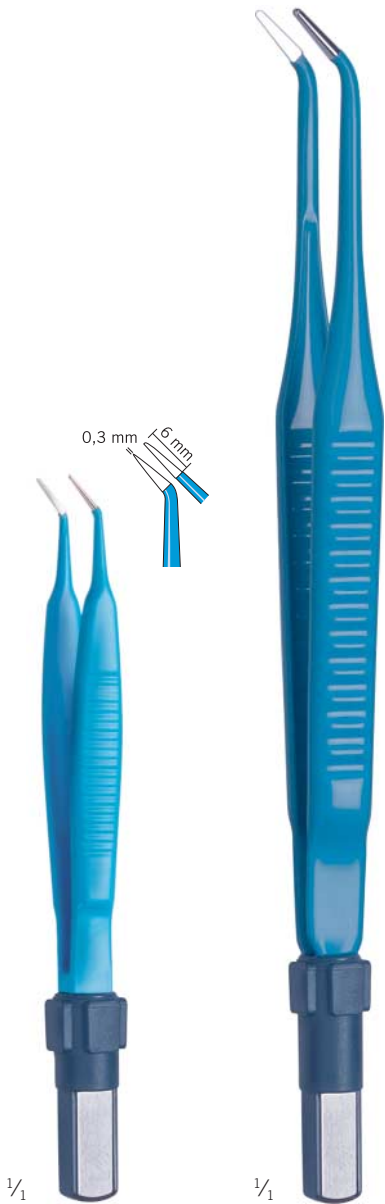

80-911-07-04  
 8,5 cm / 3 1/4"  
 spitz, 0,3 mm  
 pointed, 0,3 mm  
 puntiaguda, 0,3 mm  
 pointue, 0,3 mm  
 acuta, 0,3 mm

Beispielabbildung  
 Example illustration  
 Ilustración a modo  
 de ejemplo  
 Illustration à titre  
 d'exemple  
 Figura di esempio

**Bipolare Pinzetten, gewinkelt**  
**Bipolar forceps, angled**  
**Pinzas bipolares, acodadas**  
**Pinces bipolaires, coudées**  
**Pinze bipolari, piegate**

	Spitzenbreite Tip width Ancho de la punta Largeur des pointes Larghezza delle punte	Länge Length Longitud Longueur Lunghezza	Artikel-Nr. Item No. N.º referencia Référence Codice articolo
	0,3 mm	8 mm	
	0,3 mm	12 cm / 4 3/4"	80-911-12-04
	0,3 mm	16 cm / 6 1/4"	80-911-16-04
	0,3 mm	18 cm / 7"	80-911-18-04
	0,3 mm	20 cm / 8"	80-911-20-04
<b>stumpf/blunt/roma/mousse/smussa</b>			
	1,0 mm	12 cm / 4 3/4"	80-925-12-04
<b>stumpf/blunt/roma/mousse/smussa</b>			
	1,2 mm	16 cm / 6 1/4"	80-925-16-04
	1,2 mm	18 cm / 7"	80-925-18-04
	1,2 mm	20 cm / 8"	80-925-20-04
	1,2 mm	22 cm / 8 3/4"	80-925-22-04
<b>stumpf/blunt/roma/mousse/smussa</b>			
	2,0 mm	16 cm / 6 1/4"	80-935-16-04
	2,0 mm	18 cm / 7"	80-935-18-04
	2,0 mm	20 cm / 8"	80-935-20-04
	2,0 mm	22 cm / 8 3/4"	80-935-22-04
	2,0 mm	24 cm / 9 1/2"	80-935-24-04

max. 500 V<sub>p</sub>



1/4

Beispielabbildung  
 Example illustration  
 Ilustración a modo de ejemplo  
 Illustration à titre d'exemple  
 Figura di esempio

Bipolare Pinzetten, bajonettförmig  
 Bipolar forceps, bayonet-shaped  
 Pinzas bipolares, bayoneta  
 Pincers bipolaires à baïonnette  
 Pinze bipolari, baionetta

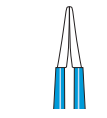

0,3 mm

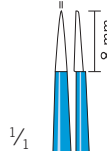

1/4

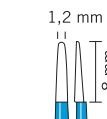

1,2 mm

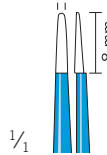

1/4

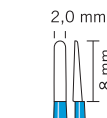

2,0 mm

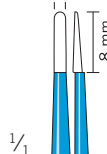

1/4

Spitzenbreite Tip width Ancho de la punta Largeur des pointes Larghezza delle punte	Länge Length Longitud Longueur Lunghezza	Artikel-Nr. Item No. N.º referencia Référence Codice articolo
---	--	---

**spitz/pointed/puntiaguda/pointue/acuta**

0,3 mm	16 cm/6 1/4"	80-931-16-04
0,3 mm	18 cm/7"	80-931-18-04
0,3 mm	20 cm/8"	80-931-20-04
0,3 mm	24 cm/9 1/2"	80-931-24-04

**stumpf/blunt/roma/mousse/smussa**

1,2 mm	16 cm/6 1/4"	80-945-16-04
1,2 mm	18 cm/7"	80-945-18-04
1,2 mm	20 cm/8"	80-945-20-04
1,2 mm	24 cm/9 1/2"	80-945-24-04

**stumpf/blunt/roma/mousse/smussa**

2,0 mm	18 cm/7"	80-948-18-04
2,0 mm	20 cm/8"	80-948-20-04
2,0 mm	24 cm/9 1/2"	80-948-24-04
2,0 mm	30 cm/11 3/4"	80-948-30-04

Bipolare Pinzetten mit verlängerter Isolation  
 Bipolar forceps with extended insulation  
 Pinzas bipolares con aislamiento delantero prolongado  
 Pinces bipolaires avec isolation prolongée  
 Pinze bipolari con isolamento prolungato

Bipolares Instrumentarium  
 Bipolar instruments  
 Instrumentos bipolares  
 Instruments bipolaires  
 Strumenti bipolari



max. 500 V<sub>p</sub>

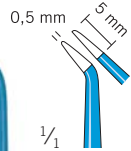
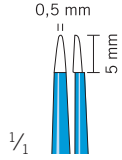

80-950-20-04  
 20 cm/8"

80-951-20-04  
 20 cm/8"

Geräte Units Equipos Appareils Apparecchi	Instrumente Instruments Instrumentos Instruments Strumenti	Europäischer Flachstecker, rund European flat plug, round Enchufe plano para Europa, redondo Fiche plate européenne, rond Spina piatta Europea, rotondo
		<p>max. 600 V<sub>p</sub>      max. 850 V<sub>p</sub></p>
KLS Martin Berchtold Aesculap		<p>80-287-33-04 3 m/10 ft.</p> <p>80-287-53-04 5 m/16 ft.</p>
maxium® „e“ Erbe ICC Erbe ACC Erbe VIO		<p>80-286-30-04 3 m/10 ft.</p> <p>80-286-50-04 5 m/16 ft.</p>
maxium® „i“ maxium® „e“ ME MB 2 „i“ ME MB 3 „i“ Valleylab		<p>80-287-89-04 3 m/10 ft.</p> <p>80-287-90-04 5 m/16 ft.</p>
Codman Valleylab		<p>80-287-72-04 5 m/16 ft.</p>



mit geradem Stecker  
 with straight plug  
 con clavija recta  
 avec fiche droite  
 con spina diritta



mit abgewinkeltem Stecker  
 with angled plug  
 con clavija acodada  
 avec fiche coude  
 con spine piegata

Bipolare Pinzetten, NON-STICK red  
 Bipolar forceps, NON-STICK red  
 Pinzas bipolares, NON-STICK red  
 Pincès bipolaires, NON-STICK red  
 Pinze bipolari, NON-STICK red

# NON-STICK red

## Modellvielfalt

Alle gängigen Abmessungen für unterschiedliche Anwendungen

## Variety of models

All common dimensions for different applications

## Diversidad de modelos

Todas las dimensiones habituales para diferentes aplicaciones

## De nombreux modèles

Toutes les dimensions courantes pour applications diverses

## Molteplicità di modelli

Tutte le dimensioni di uso comune per le diverse applicazioni

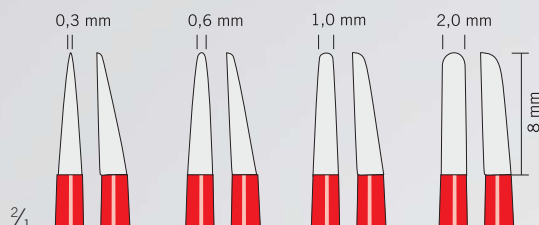

## Pinzettenspitzen

- Polierte Edelmetallspitzen
- Kein Anhaften von Gewebe

## The tips of the forceps

- Polished noble metal tips
- No tissue sticking to the tips

## Las puntas de la pinza

- Puntas de metal noble pulidas
- Sin adherencias del tejido

## Pointes de la pince

- Pointes polies en métal précieux
- Les tissus n'adhèrent pas aux pointes

## Punte delle pinze

- Punte lucidate in metallo prezioso
- Nessuna adesione al tessuto



## marSIGHT-Geometrie

- Maximale Sicht auf das OP-Feld
- Punktgenaues Fassen von Gewebe

## marSIGHT geometry

- Maximum view of the surgical site
- High-precision grasping of tissue

## Geometría marSIGHT

- Visibilidad máxima sobre el campo operatorio
- Aprisionado del tejido con precisión puntual

## Géométrie marSIGHT

- Visibilité maximale sur le champ opératoire
- Saisie ponctuelle de tissu

## Geometria marSIGHT

- Massima visibilità dal campo operatorio
- Afferraggio di alta precisione del tessuto





## revolutionary ergonomic design



- Integrierte Pinzettenführung
- Integrated guiding mechanism
- Mecanismo de guiado integrado
- Mécanisme de guidage intégré
- Meccanismo di guida integrato



- Europäischer Flachpin-Stecker
- European flat-pin plug
- Clavija europea de pin plano
- Fiche européenne à broche plate
- Spina europea a pin piatto



- Ergonomische Grifffläche für ermüdungsfreies Arbeiten
- Ergonomic handle surface prevents fatigue in the surgeon's hand
- La superficie ergonómica del mango evita la fatiga en la mano del cirujano
- Surface de la poignée ergonomique pour un travail sans fatigue
- Superficie ergonomica dell'impugnatura per lavorare senza fatica

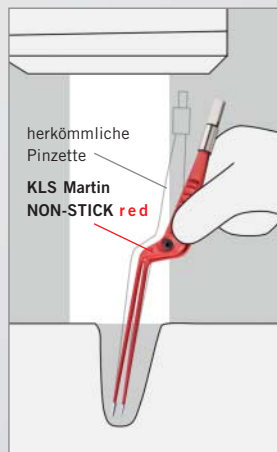

- Sichtoptimierte Schenkelgeometrie für die Anwendung unter dem OP-Mikroskop
- View-optimized shank geometry for applications under the operating microscope
- Geometría optimizada de las ramas en pro de la visibilidad para la aplicación bajo el microscopio quirúrgico
- Géométrie des branches optimisée pour une visibilité accrue sous le microscope opératoire
- Geometria delle branche a visibilità perfezionata per applicazione sotto il microscopio operatorio

max. 500 V<sub>p</sub>

## NON-STICK red



1/1



1/1

Bipolare Pinzetten, gerade  
 Bipolar forceps, straight  
 Pinzas bipolares, rectas  
 Pincas bipolaires, droites  
 Pinze bipolari, diritte

marSIGHT

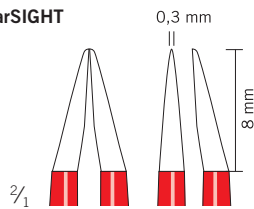

marSIGHT

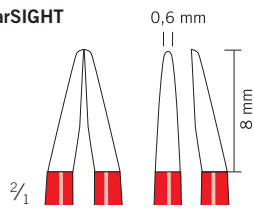

Standard

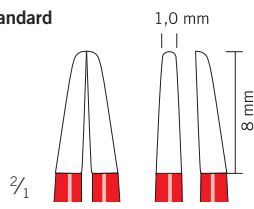

Standard

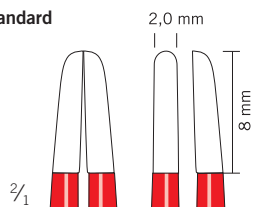

Spitzenbreite Tip width Ancho de la punta Largeur des pointes Larghezza delle punte	Länge Length Longitud Longueur Lunghezza	Artikel-Nr. Item No. N.º referencia Référence Codice articolo
---	--	---

**spitz/pointed/puntiaguda/pointue/acuta**

0,3 mm	12 cm/4 3/4"	80-982-12-04
0,3 mm	17 cm/6 1/4"	80-982-17-04
0,3 mm	20 cm/8"	80-982-20-04
0,3 mm	23 cm/9"	80-982-23-04

**stumpf/blunt/roma/mousse/smussa**

0,6 mm	12 cm/4 3/4"	80-984-12-04
0,6 mm	17 cm/6 1/4"	80-984-17-04
0,6 mm	20 cm/8"	80-984-20-04

**stumpf/blunt/roma/mousse/smussa**

1,0 mm	12 cm/4 3/4"	80-986-12-04
1,0 mm	17 cm/6 1/4"	80-986-17-04
1,0 mm	20 cm/8"	80-986-20-04
1,0 mm	23 cm/9"	80-986-23-04

**stumpf/blunt/roma/mousse/smussa**

2,0 mm	17 cm/6 1/4"	80-988-17-04
2,0 mm	20 cm/8"	80-988-20-04
2,0 mm	23 cm/9"	80-988-23-04
2,0 mm	30 cm/11 3/4"	80-988-30-04

80-982-12-04  
 12 cm/4 3/4"  
 spitz, 0,3 mm  
 pointed, 0,3 mm  
 puntiaguda, 0,3 mm  
 pointue, 0,3 mm  
 acuta, 0,3 mm

Beispielabbildung  
 Example illustration  
 Ilustración a modo de ejemplo  
 Illustration à titre d'exemple  
 Figura di esempio





max. 500 V<sub>p</sub>



**Bipolare Pinzetten, gewinkelt**  
**Bipolar forceps, angled**  
**Pinzas bipolares, acodadas**  
**Pinces bipolaires, coudées**  
**Pinze bipolari, piegate**

	Spitzenbreite Tip width Ancho de la punta Largeur des pointes Larghezza delle punte	Länge Length Longitud Longueur Lunghezza	Artikel-Nr. Item No. N.º referencia Référence Codice articolo
Standard	0,3 mm	8 mm	<b>spitz/pointed/puntiaguda/pointue/acuta</b>
		12 cm/4 3/4"	80-983-12-04
		17 cm/6 1/4"	80-983-17-04
Standard	0,6 mm	8 mm	<b>stumpf/blunt/roma/mousse/smussa</b>
		12 cm/4 3/4"	80-985-12-04
		17 cm/6 1/4"	80-985-17-04
		20 cm/8"	80-985-20-04
Standard	1,0 mm	8 mm	<b>stumpf/blunt/roma/mousse/smussa</b>
		12 cm/4 3/4"	80-987-12-04
		17 cm/6 1/4"	80-987-17-04
		20 cm/8"	80-987-20-04
		23 cm/9"	80-987-23-04
Standard	2,0 mm	8 mm	<b>stumpf/blunt/roma/mousse/smussa</b>
		17 cm/6 1/4"	80-989-17-04
		20 cm/8"	80-989-20-04
		23 cm/9"	80-989-23-04
		25 cm/9 3/4"	80-989-25-04
		28 cm/11"	80-989-28-04
		30 cm/11 3/4"	80-989-30-04

80-983-12-04  
 12 cm/4 3/4"  
 spitz, 0,3 mm  
 pointed, 0,3 mm  
 puntiaguda, 0,3 mm  
 pointue, 0,3 mm  
 acuta, 0,3 mm

Beispielabbildung  
 Example illustration  
 Ilustración a modo de ejemplo  
 Illustration à titre d'exemple  
 Figura di esempio

**KLS Martin NON-STICK red –**

die bipolaren Pinzetten von KLS Martin mit ANTIHAFTEFFEKT und revolutionärer Ergonomie  
 the bipolar forceps from KLS Martin – with NON-STICK effect and a revolutionary ergonomic design  
 las pinzas bipolares de KLS Martin con efecto ANTIADHERENTE y ergonomía revolucionaria  
 les pincés bipolaires de KLS Martin à effet ANTI-ADHÉSIF et ergonomie révolutionnaire  
 le pinze bipolari di KLS Martin con effetto ANTIADERENTE ed ergonomia rivoluzionaria

max. 500 V<sub>p</sub>

## NON-STICK red



Bipolare Pinzetten, bajonettförmig  
 Bipolar forceps, bayonet-shaped  
 Pinzas bipolares, bayoneta  
 Pincers bipolaires, à baïonnette  
 Pinze bipolari, baionetta

	Spitzenbreite Tip width Ancho de la punta Largeur des pointes Larghezza delle punte	Länge Length Longitud Longueur Lunghezza	Artikel-Nr. Item No. N.º referencia Référence Codice articolo
<b>marSIGHT</b> 	<b>spitz/pointed/puntiaguda/pointue/acuta</b>		
	0,3 mm	17 cm/6 ¼"	80-990-17-04
	0,3 mm	20 cm/8"	80-990-20-04
	0,3 mm	23 cm/9"	80-990-23-04
0,3 mm	25 cm/9 ¾"	80-990-25-04	
<b>marSIGHT</b> 	<b>stumpf/blunt/roma/mousse/smussa</b>		
	0,6 mm	17 cm/6 ¼"	80-991-17-04
	0,6 mm	20 cm/8"	80-991-20-04
	0,6 mm	23 cm/9"	80-991-23-04
0,6 mm	25 cm/9 ¾"	80-991-25-04	
<b>Standard</b> 	<b>stumpf/blunt/roma/mousse/smussa</b>		
	1,0 mm	17 cm/6 ¼"	80-992-17-04
	1,0 mm	20 cm/8"	80-992-20-04
	1,0 mm	23 cm/9"	80-992-23-04
1,0 mm	25 cm/9 ¾"	80-992-25-04	
<b>Standard</b> 	<b>stumpf/blunt/roma/mousse/smussa</b>		
	2,0 mm	17 cm/6 ¼"	80-993-17-04
	2,0 mm	20 cm/8"	80-993-20-04
	2,0 mm	23 cm/9"	80-993-23-04
2,0 mm	25 cm/9 ¾"	80-993-25-04	

Beispielabbildung  
 Example illustration  
 Ilustración a modo de ejemplo  
 Illustration à titre d'exemple  
 Figura di esempio

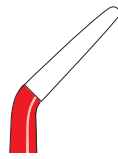

nach oben gewinkelt  
 upward-bent  
 acodada hacia arriba  
 coudée vers le haut  
 piegata in alto

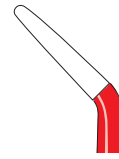

nach unten gewinkelt  
 downward-bent  
 acodada hacia abajo  
 coudée vers le bas  
 piegata in basso

**Bipolare Pinzetten, bajonettförmig, gewinkelt**  
**Bipolar forceps, bayonet-shaped, angled**  
**Pinzas bipolares, bayoneta, acodadas**  
**Pinces bipolaires, à baïonnette, coudées**  
**Pinze bipolari, baionetta, piegate**

	Spitzenbreite Tip width Ancho de la punta Largeur des pointes Larghezza delle punte	Länge Length Longitud Longueur Lunghezza	Artikel-Nr. Item No. N.º referencia Référence Codice articolo
Standard	0,6 mm	8 mm	stumpf/blunt/roma/mousse/smussa
		23 cm/9"	80-997-23-04
	0,6 mm	25 cm/9 3/4"	80-997-25-04
Standard	0,6 mm	8 mm	stumpf/blunt/roma/mousse/smussa
		23 cm/9"	80-996-23-04
	0,6 mm	25 cm/9 3/4"	80-996-25-04
Standard	1,0 mm	8 mm	stumpf/blunt/roma/mousse/smussa
		20 cm/8"	80-994-20-04
	1,0 mm	23 cm/9"	80-994-23-04
	1,0 mm	25 cm/9 3/4"	80-994-25-04
Standard	1,0 mm	8 mm	stumpf/blunt/roma/mousse/smussa
		20 cm/8"	80-995-20-04
	1,0 mm	23 cm/9"	80-995-23-04
	1,0 mm	25 cm/9 3/4"	80-995-25-04

Beispielabbildung  
 Example illustration  
 Ilustración a modo de ejemplo  
 Illustration à titre d'exemple  
 Figura di esempio

**KLS Martin NON-STICK red –**

die bipolaren Pinzetten von KLS Martin mit ANTIHAFTEFFEKT und revolutionärer Ergonomie  
 the bipolar forceps from KLS Martin – with NON-STICK effect and a revolutionary ergonomic design  
 las pinzas bipolares de KLS Martin con efecto ANTIADHERENTE y ergonomía revolucionaria  
 les pince bipolaires de KLS Martin à effet ANTI-ADHÉSIF et ergonomie révolutionnaire  
 la pinze bipolari di KLS Martin con effetto ANTIADERENTE ed ergonomia rivoluzionaria

Bipolare Pinzetten, NON-STICK red, gebogen  
 Bipolar forceps, NON-STICK red, curved  
 Pinzas bipolares, NON-STICK red, acodadas  
 Pincers bipolaires, NON-STICK red, courbes  
 Pinze bipolari, NON-STICK red, curve

revolutionary  
 ergonomic  
 design

max. 500 V<sub>p</sub>



1/1

1/1

1/1

80-998-23-04  
 23 cm/9"

80-999-23-04  
 23 cm/9"

80-999-24-04  
 23 cm/9"



Weitere Informationen entnehmen Sie bitte der separaten Broschüre.

For further information please refer to our separate product brochure.

Encontrará informaciones adicionales en el folleto individual.









Vous trouverez des informations supplémentaires dans la brochure.

Per ulteriori informazioni vedasi il prospetto separato.

Anschlusskabel für bipolare Pinzetten  
 Connection cables for bipolar forceps  
 Cables de conexión para pinzas bipolares  
 Câbles de raccordement pour pinces bipolaires  
 Cavi di connessione per pinze bipolari

Bipolares Instrumentarium  
 Bipolar instruments  
 Instrumentos bipolares  
 Instruments bipolaires  
 Strumenti bipolari



<p><b>Geräte Units Equipos Appareils Apparecchi</b></p>	<p><b>Instrumente Instruments Instrumentos Instruments Strumenti</b></p>	<p>Europäischer Flachstecker, rund European flat plug, round Enchufe plano para Europa, redondo Fiche plate européenne, rond Spina piatta Europea, rotondo</p> <p><b>max. 600 V<sub>p</sub></b>      <b>max. 850 V<sub>p</sub></b></p> 	
<p>KLS Martin Berchtold Aesculap</p>  		<p>80-287-33-04 3 m/10 ft.</p> <p>80-287-53-04 5 m/16 ft.</p>	<p>80-291-40-04 4 m/13 ft.</p>
<p>maxium® „e“ Erbe ICC Erbe ACC Erbe VIO</p>  		<p>80-286-30-04 3 m/10 ft.</p> <p>80-286-50-04 5 m/16 ft.</p>	<p>80-286-40-04 4 m/13 ft.</p>
<p>maxium® „i“ maxium® „e“ ME MB 2 „i“ ME MB 3 „i“ Valleylab</p>  		<p>80-287-89-04 3 m/10 ft.</p> <p>80-287-90-04 5 m/16 ft.</p>	<p>80-293-40-04 4 m/13 ft.</p>
<p>Codman Valleylab</p>  		<p>80-287-72-04 5 m/16 ft.</p>	



mit geradem Stecker  
 with straight plug  
 con clavija recta  
 avec fiche droite  
 con spina diritta



mit abgewinkeltem Stecker  
 with angled plug  
 con clavija acodada  
 avec fiche coudé  
 con spina piegata

Bipolare Pinzetten, NON-STICK **red**  
 Bipolar forceps, NON-STICK **red**  
 Pinzas bipolares, NON-STICK **red**  
 Pincés bipolaires, NON-STICK **red**  
 Pinze bipolari, NON-STICK **red**

# NON-STICK **red**

## Lagerung und Transport

Für die sichere Lagerung und den Transport der bipolaren NON-STICK-**red**-Pinzetten kann das neue Siebkorbssystem von KLS Martin verwendet werden.

## Storage and transport

To store and transport your NON-STICK **red** forceps safely and securely, we recommend using the new KLS Martin mesh tray system.

## Almacenaje y transporte

Para el almacenaje y transporte seguros de las pinzas bipolares NON STICK **red** puede utilizarse el nuevo sistema de bandejas cribadas de KLS Martin.

## Stockage et transport

Le nouveau système de paniers à mailles de KLS Martin garantit la fiabilité des stockage et transport des pincés bipolaires NON-STICK **red**.

## Magazzinaggio e trasporto

Per il magazzinaggio e trasporto sicuri delle pinze bipolari NON-STICK **red** è possibile usare il nuovo sistema di vassoi reticolati di KLS Martin.

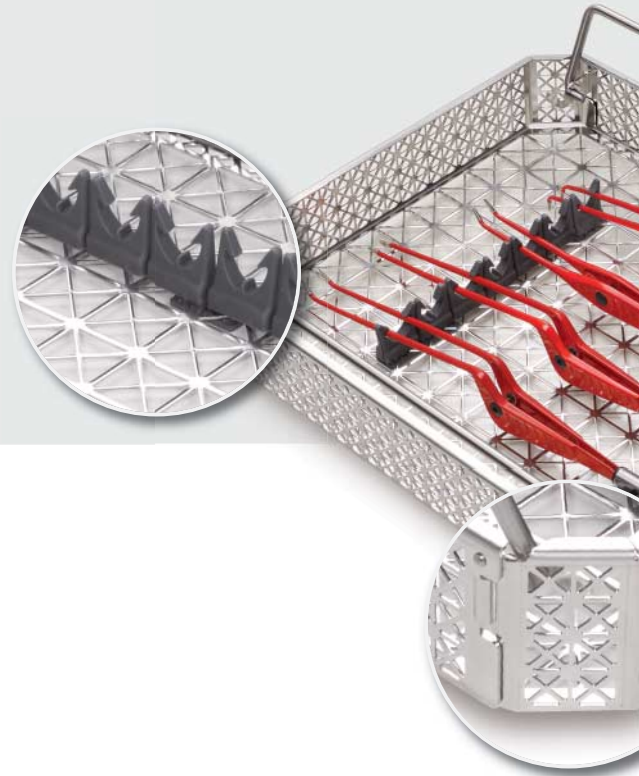

	Für Pinzetten mit einer maximalen Länge von 23 cm schlagen wir folgende Konfiguration vor:		For forceps with a maximum length of 23 cm, we recommend the following configuration:		Para pinzas con una longitud máxima de 23 cm proponemos la siguiente configuración:	
	<b>Artikelbeschreibung</b>	<b>Menge</b>	<b>Designation</b>	<b>Quantity</b>	<b>Descripción del artículo</b>	<b>Cantidad</b>
55-804-25-01	Siebkorb, 243 x 255 x 53 mm	1	Mesh tray, 243 x 255 x 53 mm	1	Bandeja cribada, 243 x 255 x 53 mm	1
55-805-28-01	Deckel, 243 x 255 mm	1	Lid, 243 x 255 mm	1	Tapa, 243 x 255 mm	1
	<b>Fixierelemente</b>		<b>Fixing elements</b>		<b>Elementos de fijación</b>	
55-806-02-04	Clip für Fixierelement (VE = 10 Stück)	1	Clip for fixing element (10/pack)	1	Clip para elemento de fijación (UE = 10 ud.)	1
55-806-07-04	Fixierelement (VE = 6 Stück)	2	Fixing element (6/pack)	2	Elemento de fijación (UE = 6 ud.)	2
	Für Pinzetten größer 23 cm sollte ein ¾-Siebkorb verwendet werden:		For forceps longer than 23 cm, a ¾-size tray should be used.		For forceps longer than 23 cm, a ¾-size tray should be used.	
	<b>Artikelbeschreibung</b>	<b>Menge</b>	<b>Designation</b>	<b>Quantity</b>	<b>Descripción del artículo</b>	<b>Cantidad</b>
55-804-42-01	Siebkorb, 410 x 255 x 53 mm	1	Mesh tray, 410 x 255 x 53 mm	1	Mesh tray, 410 x 255 x 53 mm	1
55-805-45-01	Deckel, 410 x 255 mm	1	Lid, 410 x 255 mm	1	Lid, 410 x 255 mm	1
	<b>Fixierelemente</b>		<b>Fixing elements</b>		<b>Elementos de fijación</b>	
55-806-02-04	Clip für Fixierelement (VE = 10 Stück)	1	Clip for fixing element (10/pack)	1	Clip for fixing element (10/pack)	1
55-806-07-04	Fixierelement (VE = 6 Stück)	2	Fixing element (6/pack)	2	Fixing element (6/pack)	2

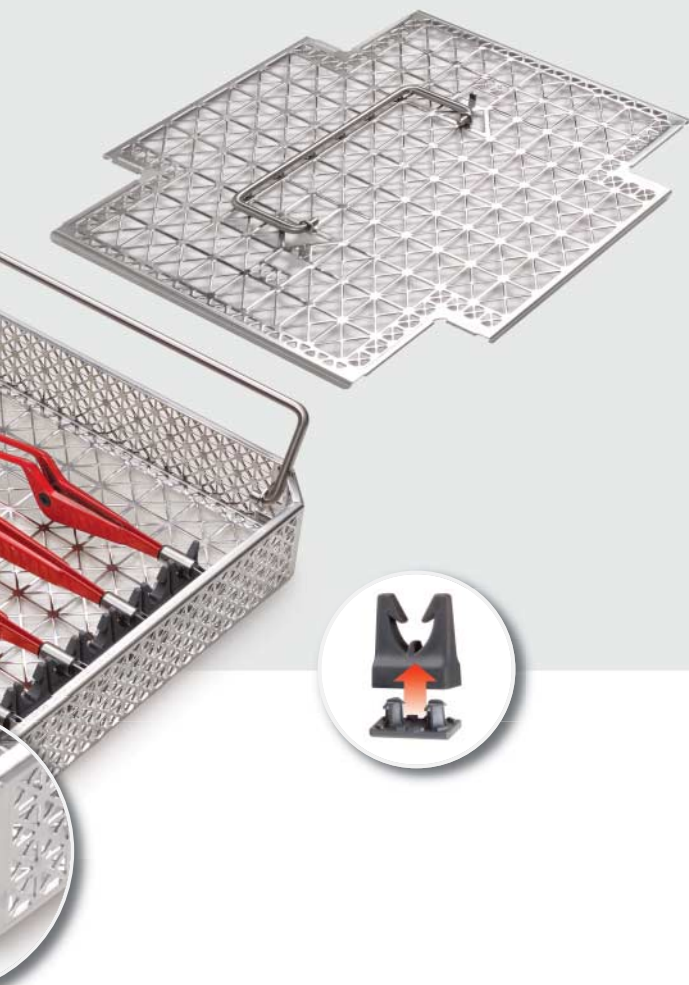

Beispiel Bestückung  
Equipment example  
Ejemplo de dotación  
Exemple chargement  
Esempio di allestimento



Fixierelemente werden in zusammenhängenden 6er-Einheiten mit drei Halteclips geliefert. Sie können jedoch problemlos mit einer Schere die Einheit trennen – ganz wie Sie es brauchen.

Fixing elements are available as 6-item strips with three holding clips. However, you can easily cut up the strips with a pair of scissors – just as you need it.

Los elementos de fijación se suministran en unidades continuas de 6 con tres clips de sujeción. No obstante, usted también puede separar sin problemas la unidad de 6 con unas tijeras, según sus requerimientos personales.

Les éléments de fixation sont livrés par unités de 6 d'un seul tenant, avec trois clips. Il vous suffit de découper ces éléments de fixation avec une paire de ciseaux – en fonction de vos besoins.

Gli elementi di fissaggio vengono forniti in confezioni di sei unità con tre clip. Potete però tagliare l'unità con un paio di forbici in base alle vostre esigenze.



	Nous proposons la configuration suivante pour les pinces de 23 cm de long au maximum:		Per pinze della lunghezza massima di 23 cm proponiamo la seguente configurazione:	
	<b>Description</b>	<b>Quantité</b>	<b>Designazione</b>	<b>Quantità</b>
55-804-25-01	Panier à mailles, 243 x 255 x 53 mm	1	Vassoio reticolato, 243 x 255 x 53 mm	1
55-805-28-01	Couvercle, 243 x 255 mm	1	Coperchio, 243 x 255 mm	1
	<b>Éléments de fixation</b>		<b>Elementi di fissaggio</b>	
55-806-02-04	Clip pour élément de fixation (UE = 10)	1	Clip per elemento di fissaggio (UV=10 pezzi)	1
55-806-07-04	Élément de fixation (UE = 6)	2	Elemento di fissaggio (UV=6 pezzi)	2
	Il est recommandé d'utiliser une panier à mailles ¾ pour les pinces de plus de 23 cm de long:		Per pinze di lunghezza superiore a 23 cm si consiglia di usare un vassoio di grandezza ¾:	
	<b>Description</b>	<b>Quantité</b>	<b>Designazione</b>	<b>Quantità</b>
55-804-42-01	Panier à mailles, 410 x 255 x 53 mm	1	Vassoio reticolato, 410 x 255 x 53 mm	1
55-805-45-01	Couvercle, 410 x 255 mm	1	Coperchio, 410 x 255 mm	1
	<b>Éléments de fixation</b>		<b>Elementi di fissaggio</b>	
55-806-02-04	Clip pour élément de fixation (UE = 10)	1	Clip per elemento di fissaggio (UV=10 pezzi)	1
55-806-07-04	Élément de fixation (UE = 6)	2	Elemento di fissaggio (UV=6 pezzi)	2

Bipolare Spülpinzetten, NON-STICK **flush**  
Bipolar irrigation forceps, NON-STICK **flush**  
Pinzas bipolares con función de enjuague, NON-STICK **flush**  
Pincas d'irrigation bipolaires, NON-STICK **flush**  
Pinze bipolari con irrigazione, NON-STICK **flush**

# NON-STICK **flush**

## Modellvielfalt

Alle gängigen Abmessungen für unterschiedliche Anwendungen

## Variety of models

All common dimensions for different applications

## Diversidad de modelos

Todas las dimensiones habituales para diferentes aplicaciones

## De nombreux modèles

Toutes les dimensions courantes pour applications diverses

## Molteplicità di modelli

Tutte le dimensioni di uso comune per le diverse applicazioni

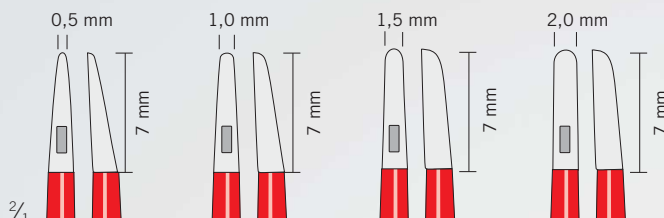

## Pinzettenspitzen

- Die Spülöffnung befindet sich direkt auf der Fassfläche

## The tips of the forceps

- The irrigation opening is located right on the gripping surfaces

## Las puntas de la pinza

- La abertura se encuentra directamente en la superficie de sujeción

## Pointes de la pince

- L'orifice d'irrigation se trouve directement sur la surface de saisie

## Punte delle pinze

- L'orificio di irrigazione si trova direttamente sulla superficie di presa







- Integration des Spülkanals in den Schenkel
- Integration of the irrigation channel in the handle
- Integración del canal de irrigación en la rama
- Intégration du canal d'irrigation dans la branche
- Integrazione del canale di irrigazione nella branca

- Zufuhr der Spülflüssigkeit über Luer-Lock Anschluss
- The irrigation fluid is supplied via the Luer Lock connection
- La alimentación del líquido se realiza a través de un conector Luer-Lock
- Le liquide d'irrigation est amené via le raccord Luer-Lock
- L'apporto del liquido di irrigazione avviene mediante il raccordo Luer-Lock



- Europäischer Flachpin-Stecker
- European flat-pin plug
- Clavija europea de pin plano
- Fiche européenne à broche plate
- Spina europea a pin piatto



- Präzise Führung der Pinzettenspitzen
- Precision guidance of forceps tips
- Guiado preciso de las puntas de las pinzas
- Les pointes de la pince sont guidées avec précision
- Meccanismo di guida precisa delle punte delle pinze

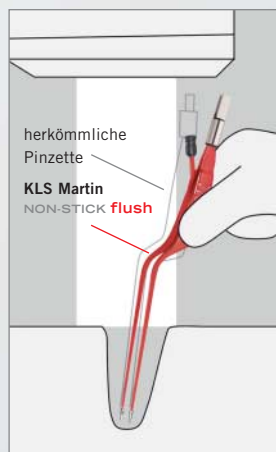

- Sichtoptimierte Schenkelgeometrie für die Anwendung unter dem OP-Mikroskop
- View-optimized shank geometry for applications under the operating microscope
- Geometría optimizada de las ramas en pro de la visibilidad para la aplicación bajo el microscopio quirúrgico
- Géométrie des branches optimisée pour une visibilité accrue sous le microscope opératoire
- Geometria delle branche a visibilità perfezionata per applicazione sotto il microscopio operatorio

Bipolare Spülpinzetten, NON-STICK **flush**  
 Bipolar irrigation forceps, NON-STICK **flush**  
 Pinzas bipolares con función de enjuague, NON-STICK **flush**  
 Pincas d'irrigation bipolaires, NON-STICK **flush**  
 Pinze bipolari con irrigazione, NON-STICK **flush**

max. 500 V<sub>p</sub>

## NON-STICK **flush**



1/1

Beispielabbildung  
 Example illustration  
 Ilustración a modo de ejemplo  
 Illustration à titre d'exemple  
 Figura di esempio

Bipolare Pinzetten, bajonettförmig, mit *einseitiger* Spülung  
 Bipolar forceps, bayonet-shaped with irrigation *on one side*  
 Pinzas bipolares, bayoneta, con función de enjuague *unilateral*  
 Pincas bipolaires, à baïonnette, avec irrigation *unilatérale*  
 Pinze bipolari, a baionetta, con irrigazione *unilaterale*:

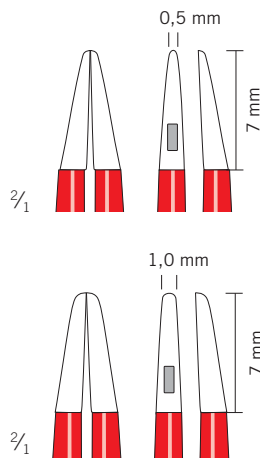

Spitzenbreite Tip width Ancho de la punta Largeur des pointes Larghezza delle punte	Länge Length Longitud Longueur Lunghezza	Artikel-Nr. Item No. N.º referencia Référence Codice articolo
---	--	---

**stumpf/blunt/roma/mousse/smussa**

0.5 x 7 mm	20 cm/8"	80-981-01-04
------------	----------	--------------

0.5 x 7 mm	23 cm/9"	80-981-03-04
------------	----------	--------------

**stumpf/blunt/roma/mousse/smussa**

1.0 x 7 mm	20 cm/8"	80-981-02-04
------------	----------	--------------

1.0 x 7 mm	23 cm/9"	80-981-04-04
------------	----------	--------------

2/1



Zubehör  
 Accessories  
 Accesorios  
 Accessoires  
 Accessori

80-981-07-04

Set Reinigungsbürsten, 5 Stück  
 Im Lieferumfang der Pinzetten sind bereits Reinigungsbürsten enthalten.

Cleaning brush set, 5 qty.  
 Cleaning brushes are included in delivery with the forceps.

Juego de cepillos de limpieza, 5 unidades  
 Las prestaciones del suministro de la pinza ya incluyen cepillos de limpieza.

Set de brosses de nettoyage, 5 pièces  
 Plusieurs brosses de nettoyage sont d'ores et déjà comprises dans l'étendue de livraison des pincas.

Set di spazzole di pulitura, 5 pezzi  
 Nella fornitura sono già comprese le spazzole di pulitura.



max. 500 V<sub>p</sub>

## NON-STICK flush

Bipolare Pinzetten, gerade, mit *einseitiger* Spülung  
 Bipolar forceps, straight, with irrigation *on one side*  
 Pinzas bipolares, rectas, con función de enjuague *unilateral*  
 Pincas bipolaires, droites, avec irrigation *unilatérale*  
 Pinze bipolari, diritte, con irrigazione *unilaterale*:

	Spitzenbreite Tip width Ancho de la punta Largeur des pointes Larghezza delle punte	Länge Length Longitud Longueur Lunghezza	Artikel-Nr. Item No. N.º referencia Référence Codice articolo
	stumpf/blunt/roma/mousse/smussa		
1.5 x 7 mm	20 cm/8"	80-981-05-04	

Bipolare Pinzetten, gerade, mit *beidseitiger* Spülung  
 Bipolar forceps, straight, with irrigation *on both sides*  
 Pinzas bipolares, rectas, con función de enjuague *bilateral*  
 Pincas bipolaires, droites, avec irrigation *bilatérale*  
 Pinze bipolari, diritte, con irrigazione *bilaterale*:

	Spitzenbreite Tip width Ancho de la punta Largeur des pointes Larghezza delle punte	Länge Length Longitud Longueur Lunghezza	Artikel-Nr. Item No. N.º referencia Référence Codice articolo
	stumpf/blunt/roma/mousse/smussa		
2.0 x 7 mm	23 cm/9"	80-981-06-04	



#### Anwendungsbeispiele:

- Viszeralchirurgie
- Leberchirurgie

#### Application examples:

- Visceral Surgery
- Liver surgery

#### Ejemplos de aplicación:

- Cirugía visceral
- Cirugía hígado

#### Exemples d'applications:

- Chirurgie viscérale
- Chirurgie du foie

#### Esempi di applicazione:

- Chirurgia viscerale
- Chirurgia fegato

Beispielabbildung  
 Example illustration  
 Ilustración a modo de ejemplo  
 Illustration à titre d'exemple  
 Figura di esempio

Beispielabbildung  
 Example illustration  
 Ilustración a modo de ejemplo  
 Illustration à titre d'exemple  
 Figura di esempio

Bipolare Spülpinzetten, NON-STICK **flush**  
Bipolar irrigation forceps, NON-STICK **flush**  
Pinzas bipolares con función de enjuague, NON-STICK **flush**  
Pincas d'irrigation bipolaires, NON-STICK **flush**  
Pinze bipolari con irrigazione, NON-STICK **flush**

## maxium® and NON-STICK **flush**

*EHT – eine wirksame NON-STICK-Methode in der Elektrochirurgie*  
*EHT – an effective NON-STICK method in electrosurgery*  
*EHT – un método NON-STICK eficaz en electrocirugía*  
*EHT – une méthode NON-STICK efficace en électrochirurgie*  
*EHT – un efficace metodo NON-STICK in elettrochirurgia*



Neptun



Neptun  
Auto-Start

Die bipolare Stromart „**Neptun**“ des HF-Generators maxium® wurde speziell für die flüssigkeitsunterstützte HF-Koagulation entwickelt (**EHT = Elektrohydrothermosation**). Diese Methode hat sich speziell bei Anwendungen in der Viszeral- und Neurochirurgie bewährt. Die bipolare Koagulation erfolgt indirekt über die erhitzte isotonische Kochsalzlösung. Die Stromart ist an die Bedürfnisse der bipolaren Spülpinzetten **NON-STICK flush** angepasst.

**Natürlich sind die NON-STICK flush-Pinzetten auch mit den am Markt gängigen HF-Generatoren einsetzbar.**

The "**Neptun**" current type of the maxium® HF generator was developed specifically for fluid-assisted HF coagulation (**EHT = electrohydrothermosation**). This method has been well proven, especially in abdominal and neurosurgery applications. Bipolar coagulation is carried out indirectly via the heated isotonic saline solution. The type of current is adapted to the requirements of the **NON-STICK flush** bipolar irrigation forceps.

**The NON-STICK flush forceps can naturally also be used with currently available HF generators.**

El tipo de corriente bipolar "**Neptun**" del generador de AF maxium® ha sido especialmente desarrollado para la coagulación de AF asistida por líquido (**EHT = electrohydrothermosation**). Este método se ha acreditado especialmente en aplicaciones de la cirugía visceral y la neurocirugía. La coagulación se realiza indirectamente a través del suero fisiológico isotónico caliente. Este tipo de corriente está adaptado a los requerimientos de la pinza bipolar con función de enjuague **NON-STICK flush**.

**Naturalmente, las pinzas NON-STICK flush también pueden utilizarse con los generadores de AF habituales del mercado.**

Le type de courant bipolaire «**Neptun**» du générateur HF maxium® a été spécialement conçu pour la coagulation HF assistée par liquide (**EHT = electrohydrothermosation**). Cette méthode a fait notamment ses preuves dans les applications en chirurgie viscérale et en neurochirurgie. La coagulation bipolaire s'effectue indirectement via la solution isotonique de chlorure de sodium chauffée. Ce type de courant est adapté aux exigences des pinces d'irrigation bipolaires **NON-STICK flush**.

**Il va de soi que les pinces NON-STICK flush peuvent également être employées avec les générateurs HF que l'on trouve couramment sur le marché.**











Il tipo di corrente bipolare "**Neptun**" del generatore AF maxium® è stato realizzato appositamente per la coagulazione AF liquido-assistita (**EHT = electrohydrothermosation**). Questo metodo ha dimostrato la propria efficacia soprattutto in applicazioni di chirurgia viscerale e neurologica. La coagulazione bipolare avviene indirettamente sulla soluzione fisiologica isotonica riscaldata. Questo tipo di corrente è adattato ai requisiti delle pinze bipolari con irrigazione **NON-STICK flush**.

**Naturalmente le pinze NON-STICK flush possono essere utilizzate anche con i generatori AF comunemente in commercio.**

Anschlusskabel für bipolare Pinzetten  
 Connection cables for bipolar forceps  
 Cables de conexión para pinzas bipolares  
 Câbles de raccordement pour pinces bipolaires  
 Cavi di connessione per pinze bipolari

Bipolares Instrumentarium  
 Bipolar instruments  
 Instrumentos bipolares  
 Instruments bipolaires  
 Strumenti bipolari



<p><b>Geräte Units Equipos Appareils Apparecchi</b></p>	<p><b>Instrumente Instruments Instrumentos Instruments Strumenti</b></p>	<p>Europäischer Flachstecker, rund European flat plug, round Enchufe plano para Europa, redondo Fiche plate européenne, rond Spina piatta Europea, rotondo</p> <p><b>max. 600 V<sub>p</sub></b>      <b>max. 850 V<sub>p</sub></b></p>  	
<p>KLS Martin Berchtold Aesculap</p>  		<p>80-287-33-04 3 m/10 ft.</p> <p>80-287-53-04 5 m/16 ft.</p>	<p>80-291-40-04 4 m/13 ft.</p>
<p>maxium® „e“ Erbe ICC Erbe ACC Erbe VIO</p>  		<p>80-286-30-04 3 m/10 ft.</p> <p>80-286-50-04 5 m/16 ft.</p>	<p>80-286-40-04 4 m/13 ft.</p>
<p>maxium® „i“ maxium® „e“ ME MB 2 „i“ ME MB 3 „i“ Valleylab</p>  		<p>80-287-89-04 3 m/10 ft.</p> <p>80-287-90-04 5 m/16 ft.</p>	<p>80-293-40-04 4 m/13 ft.</p>
<p>Codman Valleylab</p>  		<p>80-287-72-04 5 m/16 ft.</p>	



mit geradem Stecker  
 with straight plug  
 con clavija recta  
 avec fiche droite  
 con spina diritta



mit abgewinkeltem Stecker  
 with angled plug  
 con clavija acodada  
 avec fiche coudé  
 con spine piegate

Weitere Informationen entnehmen Sie bitte der separaten Broschüre sowie unseren Anwendungsberichten.

For further information please refer to our separate product brochure and our application reports.

Encontrará informaciones adicionales en el folleto individual y nuestros informes de aplicación.

Vous trouverez des informations supplémentaires dans la brochure et dans nos rapports d'application.

Per ulteriori informazioni vedasi il prospetto separato ed i nostri rapporti d'applicazione.

Übersicht der Wechselelektroden  
Overview of exchangeable electrodes  
Resumen de los electrodos intercambiables  
Présentation des électrodes interchangeables  
Presentazione degli elettrodi intercambiabili

Arbeitslänge 34 cm  
Working length 34 cm  
Longitud de trabajo 34 cm  
Longueur d'utilisation 34 cm  
Lunghezza dell'uso 34 cm

max. 500 V<sub>p</sub>



83-585-03-04  
marLap<sup>®</sup> Cut

Scheren-Wechselelektrode, gebogen, 340 mm,  
zum mechanischen Schneiden bei gleichzeitiger Koagulation

Scissor-type exchangeable electrode, curved, 340 mm,  
for mechanical cutting and simultaneous coagulation

Electrodo intercambiable tipo tijeras, 340 mm,  
para el corte mecánico y coagulación simultánea

Électrode ciseaux interchangeable, 340 mm,  
pour la coupe mécanique avec coagulation simultanée

Elettrodo intercambiabile tipo forbici, 340 mm,  
per l'incisione meccanica in condizioni di coagulazione simultanea



83-585-05-04  
marLap<sup>®</sup> Clamp

Fasszangen-Wechselelektrode, gefenestert, 340 mm,  
zur Versiegelung von Gefäßen und Gewebebündeln

Grasping forceps exchangeable electrode, fenestrated, 340 mm,  
for sealing vessels and tissue bundles

Electrodo intercambiable tipo pinza de secuestros, con ventana, 340 mm,  
para el sellado vascular y de haces de tejido

Électrode pince interchangeable, fenêtrée, 340 mm,  
pour le clamage des vaisseaux et des faisceaux de tissus

Elettrodo intercambiabile tipo clamp, con finestra, 340 mm,  
per la coagulazione di vasi e di fasci di tessuto



83-585-06-04  
marLap<sup>®</sup> Maryland

Fasszangen-Wechselelektrode, gebogen, 340 mm,  
zum Präparieren und Koagulieren

"Grasping forceps" exchangeable electrode,  
curved, 340 mm, for dissecting and coagulating

Electrodo intercambiable tipo pinza de secuestros, acodado,  
340 mm, para diseccionar y coagular

Électrode pince interchangeable, courbe, 340 mm,  
pour la dissection et la coagulation

Elettrodo intercambiabile tipo clamp, versione curva, 340 mm,  
piegato, per le operazioni di preparazione e per  
la coagulazione



83-585-07-04  
marLap<sup>®</sup> Clamp

Fasszangen-Wechselelektrode, ungefenestert, glatt, 340 mm,  
zur Versiegelung von Gefäßen und Gewebebündeln

Grasping forceps exchangeable electrode, non-fenestrated, smooth, 340 mm,  
for sealing vessels and tissue bundles

Electrodo intercambiable tipo pinza de secuestros, no fenestrado, 340 mm,  
para el sellado vascular y de haces de tejido

Électrode pince interchangeable, non fenêtrée, 340 mm,  
pour le clamage des vaisseaux et des faisceaux de tissus

Elettrodo intercambiabile tipo clamp, senza finestra,  
liscio, 340 mm, per la coagulazione di vasi e  
di fasci di tessuto





*max. 500 V<sub>p</sub>*



83-585-00-04 *max. 500 V<sub>p</sub>*

marLap® 340 mm, Ø 5 mm

Handgriff mit Schaft  
Handle with shaft  
Mango con vástago  
Manche avec tige  
Manico con asta



Passende Anschlusskabel  
finden Sie auf Seite 67!

For suitable connection cables,  
please refer to page 67!

¡Los cables de conexión apropiados  
los encontrará en la página 67!

Vous trouverez les câbles de raccordement  
adéquats à la page 67!

Per cavo di connessione adatto  
vedasi a pagina 67!

Bipolare Elektroden für die Arthroskopie  
 Bipolar Electrodes for Arthroscopy  
 Electrodo bipolar para la artroscopia  
 Electrodes bipolaires pour arthroscopie  
 Elettrodi bipolari per artroscopia



- |   |   |   |  |
|---|---|---|--|
| <input checked="" type="checkbox"/> Ergonomisch | <input checked="" type="checkbox"/> Ergonomic | <input checked="" type="checkbox"/> Ergonómicos | <input checked="" type="checkbox"/> Ergonomiques |
| <input checked="" type="checkbox"/> Kompakt     | <input checked="" type="checkbox"/> Compact   | <input checked="" type="checkbox"/> Compactos   | <input checked="" type="checkbox"/> Compactes    |
| <input checked="" type="checkbox"/> Sicher      | <input checked="" type="checkbox"/> Safe      | <input checked="" type="checkbox"/> Seguros     | <input checked="" type="checkbox"/> Sûres        |

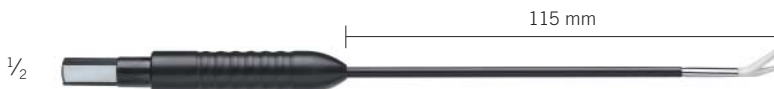

1/2



1/1



80-650-00-04 **max. 1000 V<sub>p</sub>**

Bipolare Elektrode „COBRA“, Länge 115 mm  
 “COBRA” bipolar electrode, length 115 mm  
 Electrodo bipolar “COBRA”, longitud 115 mm  
 Electrode bipolaire «COBRA», longueur 115 mm  
 Elettrodo bipolare “COBRA”, lunghezza 115 mm



1/2



1/1



80-651-00-04 **max. 1000 V<sub>p</sub>**

Bipolare Hakenelektrode, Länge 115 mm, 0,6 mm  
 Bipolar hook electrode, length 115 mm, 0,6 mm  
 Electrodo bipolar de gancho, longitud 115 mm, 0,6 mm  
 Electrode à crochet bipolaire, longueur 115 mm, 0,6 mm  
 Elettrodo bipolare ad uncino, lunghezza 115 mm, 0,6 mm



1/2



1/1



80-652-00-04 **max. 1000 V<sub>p</sub>**

Bipolare Vaporisationselektrode „PHAZER“, biegsam, inkl. Biegehilfe (80-652-01-04)  
 “PHAZER” bipolar vaporization electrode, flexible, incl. bending device (80-652-01-04)  
 Electrodo de vaporización bipolar “PHAZER”, flexible, incluye dispositivo de torsión (80-652-01-04)  
 Electrode de vaporisation bipolaire «PHAZER», flexible, avec dispositif de pliage (80-652-01-04)  
 Elettrodo di vaporizzazione bipolare “PHAZER”, flessibile, compreso dispositivo di curvatura (80-652-01-04)



1/2

80-652-01-04

Biegehilfe  
 Bending device  
 Dispositivo de torsión  
 Dispositif de pliage  
 Dispositivo di curvatura



Bipolares Instrumentarium  
 Bipolar instruments  
 Instrumentos bipolares  
 Instruments bipolaires  
 Strumenti bipolari



**COBRA**  
 Electrode



- Ergonomici
- Compatti
- Sicuri

**maxium®**



Weitere Informationen entnehmen Sie bitte der separaten Broschüre.  
 For further information please refer to our separate product brochure.  
 Encontrará informaciones adicionales en el folleto individual.  
 Vous trouverez des informations supplémentaires dans la brochure.  
 Per ulteriori informazioni vedasi il prospetto separato.



Schnittstelle Generator  
 Interface generator  
 Interfaz generador  
 Interface générateur  
 Interfaccia generatore

Schnittstelle Elektrode  
 Interface electrode  
 Interface electrodo  
 Interface électrode  
 Interface elettrodo

Schnittstelle Generator  
 Interface generator  
 Interfaz generador  
 Interface générateur  
 Interfaccia generatore

Schnittstelle Elektrode  
 Interface electrode  
 Interface electrodo  
 Interface électrode  
 Interface elettrodo

1/3



80-288-70-04 **max. 700 V<sub>p</sub>**  
 3 m/10 ft.

Anschlusskabel für bipolare Elektroden, maxium® „m“-Version  
 Connecting cable for bipolar electrodes, maxium®, „m“-version  
 Cable de conexión para electrodos bipolares, maxium®, versión „m“  
 Câble de raccordement pour électrodes bipolaires, maxium®, version «m»  
 Cavo di collegamento per elettrodi bipolari, maxium®, versione “m”

1/3



80-288-72-04 **max. 700 V<sub>p</sub>**  
 3 m/10 ft.

Anschlusskabel für bipolare Elektroden, maxium® „i“-Version  
 Connecting cable for bipolar electrodes, maxium®, „i“-version  
 Cable de conexión para electrodos bipolares, maxium®, versión “i”  
 Câble de raccordement pour électrodes bipolaires, maxium®, version «i»  
 Cavo di collegamento per elettrodi bipolari, maxium®, versione “i”



**mar**Clamp® IQ



**mar**Seal 5 IQ



**mar**Clamp® CUT IQ



INSTRUMENTARIUM ZUR BIPOLAREN  
GEFÄSSVERSIEGELUNG

INSTRUMENTS FOR  
BIPOLAR VESSEL SEALING

INSTRUMENTOS PARA  
EL SELLADO VASCULAR BIPOLAR

INSTRUMENTS POUR LA CLAMPAGE  
VASCULAIRE BIPOLAIRE

STRUMENTI DI SIGILLATURA  
VASCOLARE BIPOLARE

73-89



maxium®



Bipolare Klemmen für die Gefäßversiegelung  
 Bipolar forceps for vessel sealing  
 Pinzas bipolares para el sellado vascular  
 Pincas bipolaires pour le clamage vasculaire  
 Pinze bipolari per clampaggio vascolare

**marClamp®**



80-287-33-04 80-287-53-04  
 3 m/10 ft. 5 m/16 ft.

KLS-Martin- und Berchtold-Geräte  
 → bipolare Instrumente

KLS Martin and Berchtold units  
 → bipolar instruments

aparatos KLS Martin y Berchtold  
 → instrumentos bipolares

appareils KLS Martin et Berchtold  
 → instruments bipolaires

apparecchi KLS Martin e Berchtold  
 → strumenti bipolari



80-286-30-04 80-286-50-04  
 3 m/10 ft. 5 m/16 ft.

maxium® „e“-Version/Erbe-Geräte ICC und ACC/VIO  
 → bipolare Instrumente

maxium® "e"-Version/ICC and ACC/VIO Erbe units  
 → bipolar instruments

maxium® versión "e"/aparatos Erbe ICC e ACC/VIO  
 → instrumentos bipolares

maxium® version «e»/appareils Erbe ICC et ACC/VIO  
 → instruments bipolaires

maxium® versione "e"/apparecchi Erbe ICC e ACC/VIO  
 → strumenti bipolari



80-287-89-04 80-287-90-04  
 3 m/10 ft. 5 m/16 ft.

maxium® „i“-Version, ME MB 3 „i“-Version, ME MB 2  
 „i“-Version /Valleylab-Geräte → bipolare Instrumente

maxium® "i"-Version/ME MB 3 "i"-Version, ME MB 2  
 "i"-Version/Valleylab units → bipolar instruments

maxium® versión "i"/ME MB 3 versión "i"/ ME MB 2  
 versión "i"/aparatos Valleylab → instrumentos bipolares

maxium® version «i», ME MB 3 version «i», ME MB 2  
 version «i»/appareils Valleylab → instruments bipolaires

maxium® versione "i", ME MB 3 versione "i"/ ME MB 2  
 versione "i"/apparecchi Valleylab → strumenti bipolari

**marClamp®, gebogene Version**  
**marClamp®, curved version**  
**marClamp®, versión curva**  
**marClamp®, version courbe**  
**marClamp®, versione curva**

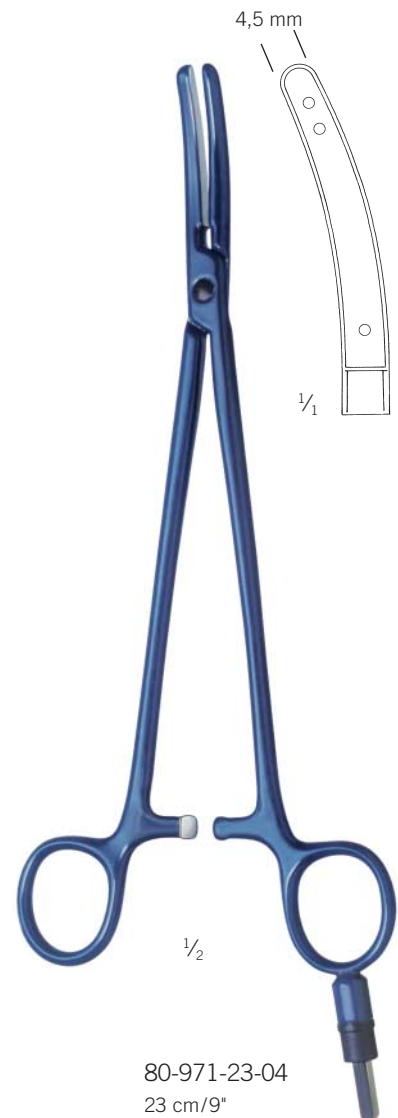



maxium®



80-287-72-04  
 5 m/16 ft.

Codman- und Valleylab-Geräte  
 → bipolare Instrumente

Codman and Valleylab units  
 → bipolar instruments

aparatos Codman y Valleylab  
 → instrumentos bipolares

appareils Codman et Valleylab  
 → instruments bipolaires

apparecchi Codman e Valleylab  
 → strumenti bipolari

Weitere Informationen finden Sie im separaten Prospekt marClamp® sowie im Prospekt „Wirkungsprinzip und Technische Grundlagen“.

For further information, please refer to the separate marClamp® brochure and our brochure on “Working Principle and Technical Foundations”.

Encontrará informaciones adicionales en el folleto individual marClamp®, así como en el folleto “Working Principle and Technical Foundations” (Principio funcional y fundamentos técnicos).

Vous trouverez des informations supplémentaires dans la brochure marClamp®, ainsi que dans le prospectus «Working Principle and Technical Foundations» (Principe d'action et bases techniques).

Per ulteriori informazioni vedasi il prospetto separato marClamp® e l'opuscolo “Working Principle and Technical Foundations” (Principio di funzionamento e fondamenti tecnici).



80-971-28-04  
 28 cm/11"

maxium®



**Bitte beachten Sie, dass die marClamp®-Modelle ausschließlich mit dem HF-Generator maxium® sowie der Stromart SealSafe eingesetzt werden dürfen.**

**Please note that the marClamp® models are intended for exclusive use with the maxium® HF generator and its SealSafe current.**

**Rogamos que observe que los modelos marClamp® únicamente pueden utilizarse con el generador de AF maxium® y el tipo de corriente SealSafe.**

**Veillez noter que les modèles marClamp® sont à employer exclusivement avec le générateur HF maxium® ainsi qu'avec le type de courant SealSafe.**

**Si prega di osservare che i modelli marClamp® possono essere utilizzati unicamente con il generatore AF maxium® e con il tipo di corrente SealSafe.**



Bipolare Klemmen für die Gefäßversiegelung  
 Bipolar forceps for vessel sealing  
 Pinzas bipolares para el sellado vascular  
 Pincers bipolaires pour le clamage vasculaire  
 Pinze bipolari per clampaggio vascolare



80-287-33-04 80-287-53-04  
 3 m/10 ft. 5 m/16 ft.  
 KLS-Martin- und Berchtold-Geräte  
 → bipolare Instrumente  
 KLS Martin and Berchtold units  
 → bipolar instruments  
 aparatos KLS Martin y Berchtold  
 → instrumentos bipolares  
 appareils KLS Martin et Berchtold  
 → instruments bipolaires  
 apparecchi KLS Martin e Berchtold  
 → strumenti bipolari



80-286-30-04 80-286-50-04  
 3 m/10 ft. 5 m/16 ft.  
 maxium® „e“-Version/Erbe-Geräte ICC und ACC/VIO  
 → bipolare Instrumente  
 maxium® "e"-Version/ICC and ACC/VIO Erbe units  
 → bipolar instruments  
 maxium® versión "e"/aparatos Erbe ICC e ACC/VIO  
 → instrumentos bipolares  
 maxium® version «e»/appareils Erbe ICC et ACC/VIO  
 → instruments bipolaires  
 maxium® versione "e"/apparecchi Erbe ICC e ACC/VIO  
 → strumenti bipolari



80-287-89-04 80-287-90-04  
 3 m/10 ft. 5 m/16 ft.  
 maxium® „i“-Version, ME MB 3 „i“-Version, ME MB 2  
 „i“-Version /Valleylab-Geräte → bipolare Instrumente  
 maxium® "i"-Version/ME MB 3 "i"-Version, ME MB 2  
 "i"-Version/Valleylab units → bipolar instruments  
 maxium® versión "i"/ME MB 3 versión "i"/ ME MB 2  
 versión "i"/aparatos Valleylab → instrumentos bipolares  
 maxium® version «i», ME MB 3 version «i», ME MB 2  
 version «i»/appareils Valleylab → instruments bipolaires  
 maxium® versione "i", ME MB 3 versione "i"/ ME MB 2  
 versione "i"/apparecchi Valleylab → strumenti bipolari

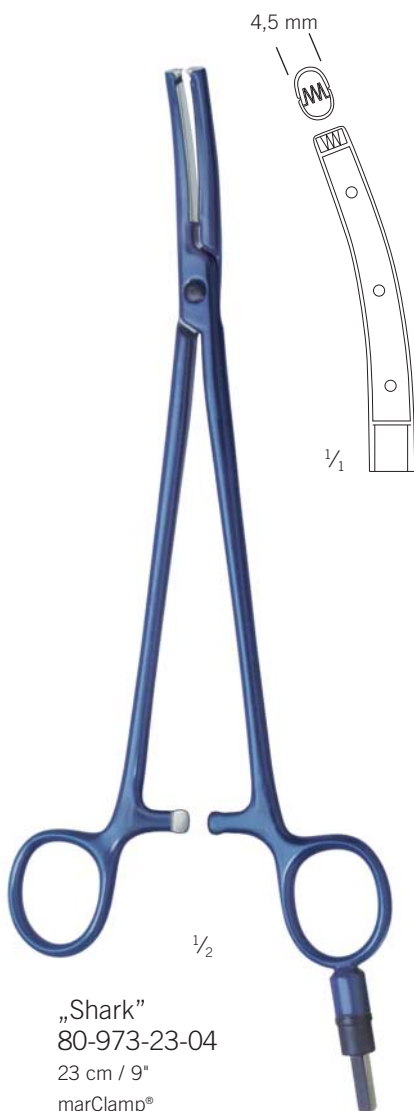

„Shark“  
 80-973-23-04  
 23 cm / 9"  
 marClamp®

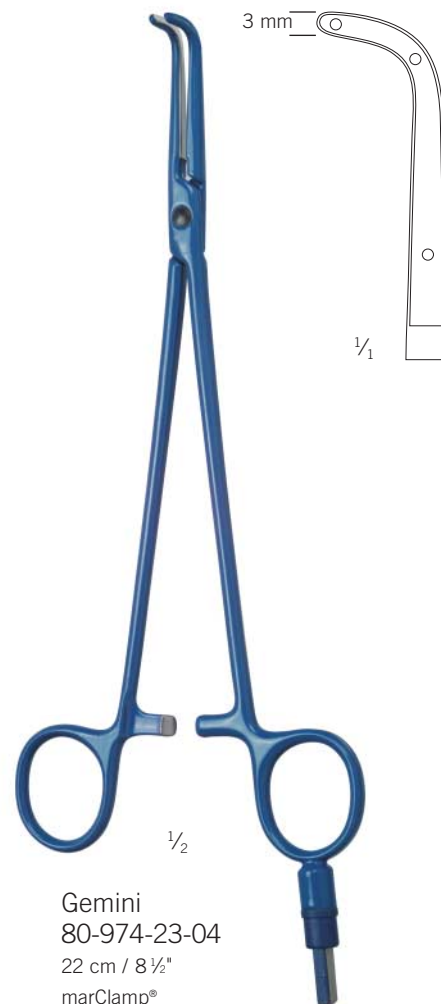

Gemini  
 80-974-23-04  
 22 cm / 8½"  
 marClamp®



maxium®



80-287-72-04  
 5 m/16 ft.

Codman- und Valleylab-Geräte  
 → bipolare Instrumente

Codman and Valleylab units  
 → bipolar instruments

aparatos Codman y Valleylab  
 → instrumentos bipolares

appareils Codman et Valleylab  
 → instruments bipolaires

apparecchi Codman e Valleylab  
 → strumenti bipolari

Weitere Informationen entnehmen Sie bitte der separaten Broschüre.

For further information please refer to our separate product brochure.

Encontrará informaciones adicionales en el folleto individual.

Vous trouverez des informations supplémentaires dans la brochure.

Per ulteriori informazioni vedasi il prospetto separato.



maxium®



**Bitte beachten Sie, dass die marClamp®-Modelle ausschließlich mit dem HF-Generator maxium® sowie der Stromart SealSafe eingesetzt werden dürfen.**

**Please note that the marClamp® models are intended for exclusive use with the maxium® HF generator and its SealSafe current.**

**Rogamos que observe que los modelos marClamp® únicamente pueden utilizarse con el generador de AF maxium® y el tipo de corriente SealSafe.**

**Veillez noter que les modèles marClamp® sont à employer exclusivement avec le générateur HF maxium® ainsi qu'avec le type de courant SealSafe.**

**Si prega di osservare che i modelli marClamp® possono essere utilizzati unicamente con il generatore AF maxium® e con il tipo di corrente SealSafe.**



Bipolare Klemmen für die Gefäßversiegelung  
 Bipolar forceps for vessel sealing  
 Pinzas bipolares para el sellado vascular  
 Pincas bipolaires pour le clamage vasculaire  
 Pinze bipolari per clampaggio vascolare

**marClamp® IQ**

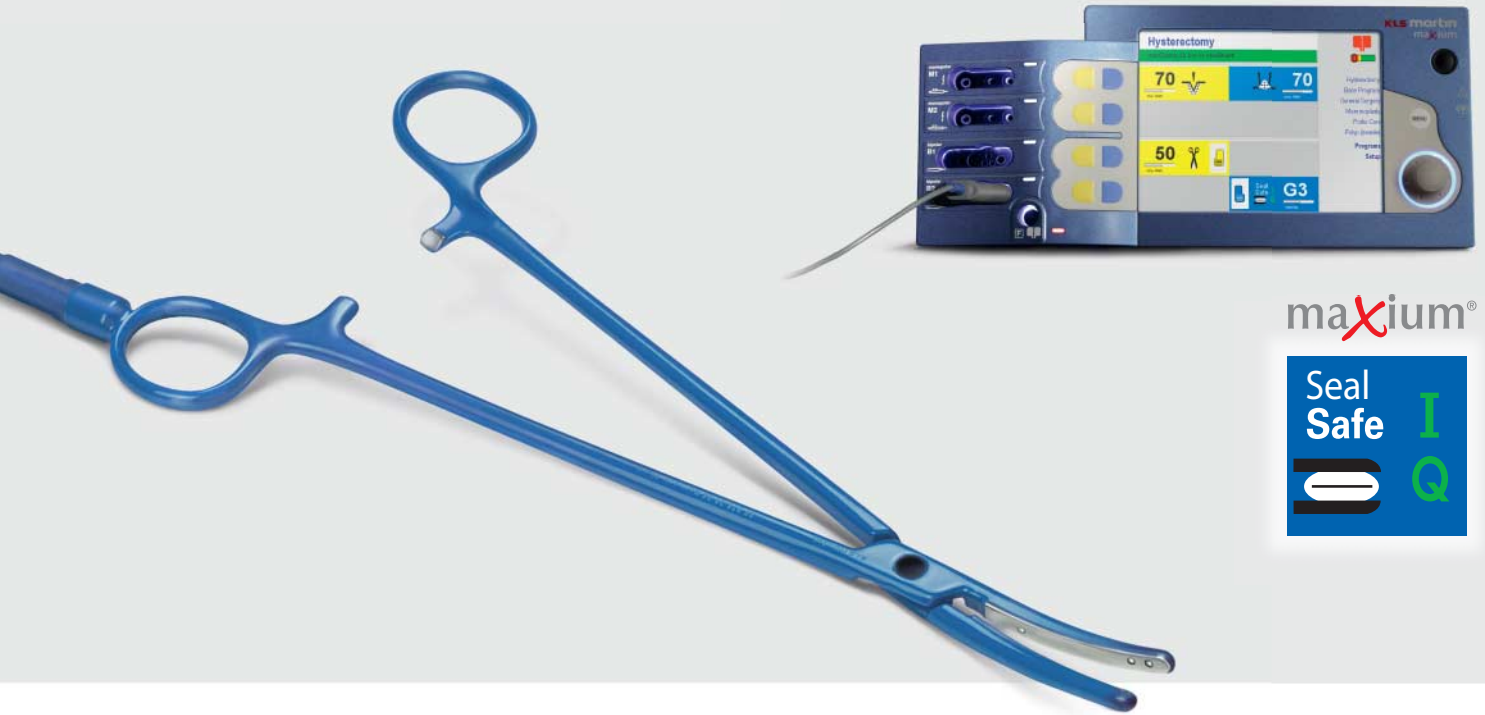

maxium®



marClamp®, gebogene Version  
 marClamp®, curved version  
 marClamp®, versión curva  
 marClamp®, version courbe  
 marClamp®, versione curva

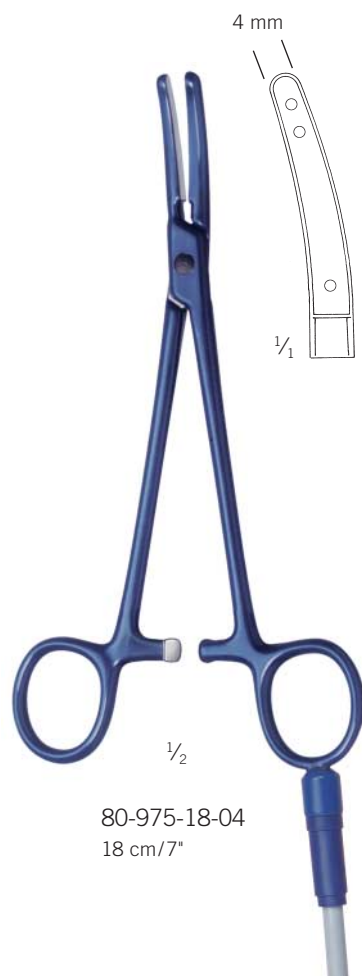



Bipolare Gefäßversiegelung  
 Bipolar vessel sealing  
 Sellado vascular bipolar  
 Clampage vasculaire bipolaire  
 Sigillatura vascolare bipolare



- Präparieren
- Versiegeln
- Plug & Play**
- Wiederverwendbar

- Dissect
- Seal
- Plug & Play**
- Reusable

- Diseccionar
- Sellar
- Plug & Play**
- Reutilizable

- Disséquer
- Clamper
- Plug & Play**
- Réutilisable

- Sezionare
- Sigillare
- Plug & Play**
- Riutilizzabile

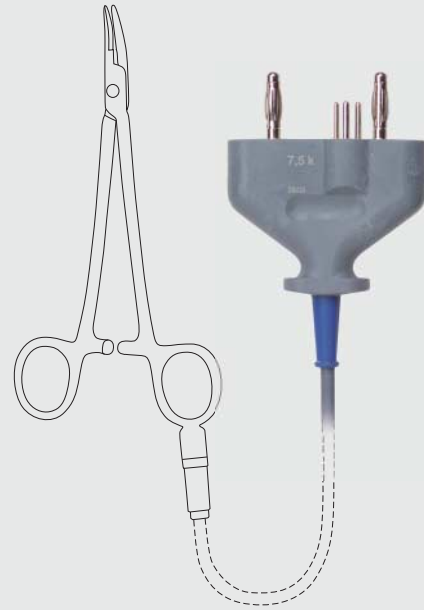

80-975-28-04  
 28 cm / 11"



Weitere Informationen finden Sie im separaten Prospekt marClamp® sowie im Prospekt „Wirkungsprinzip und Technische Grundlagen“.

For further information, please refer to the separate marClamp® brochure and our brochure on “Working Principle and Technical Foundations”.

Encontrará informaciones adicionales en el folleto individual marClamp®, así como en el folleto “Working Principle and Technical Foundations” (Principio funcional y fundamentos técnicos).

Vous trouverez des informations supplémentaires dans la brochure marClamp® ainsi que dans le prospectus «Working Principle and Technical Foundations» (Principe d'action et bases techniques).

Per ulteriori informazioni vedasi il prospetto separato marClamp® e l'opuscolo “Working Principle and Technical Foundations” (Principio di funzionamento e fondamenti tecnici).



Bipolare Klemmen für die Gefäßversiegelung  
 Bipolar forceps for vessel sealing  
 Pinzas bipolares para el sellado vascular  
 Pinces bipolaires pour le clamage vasculaire  
 Pinze bipolari per clampaggio vascolare

**marClamp® IQ**

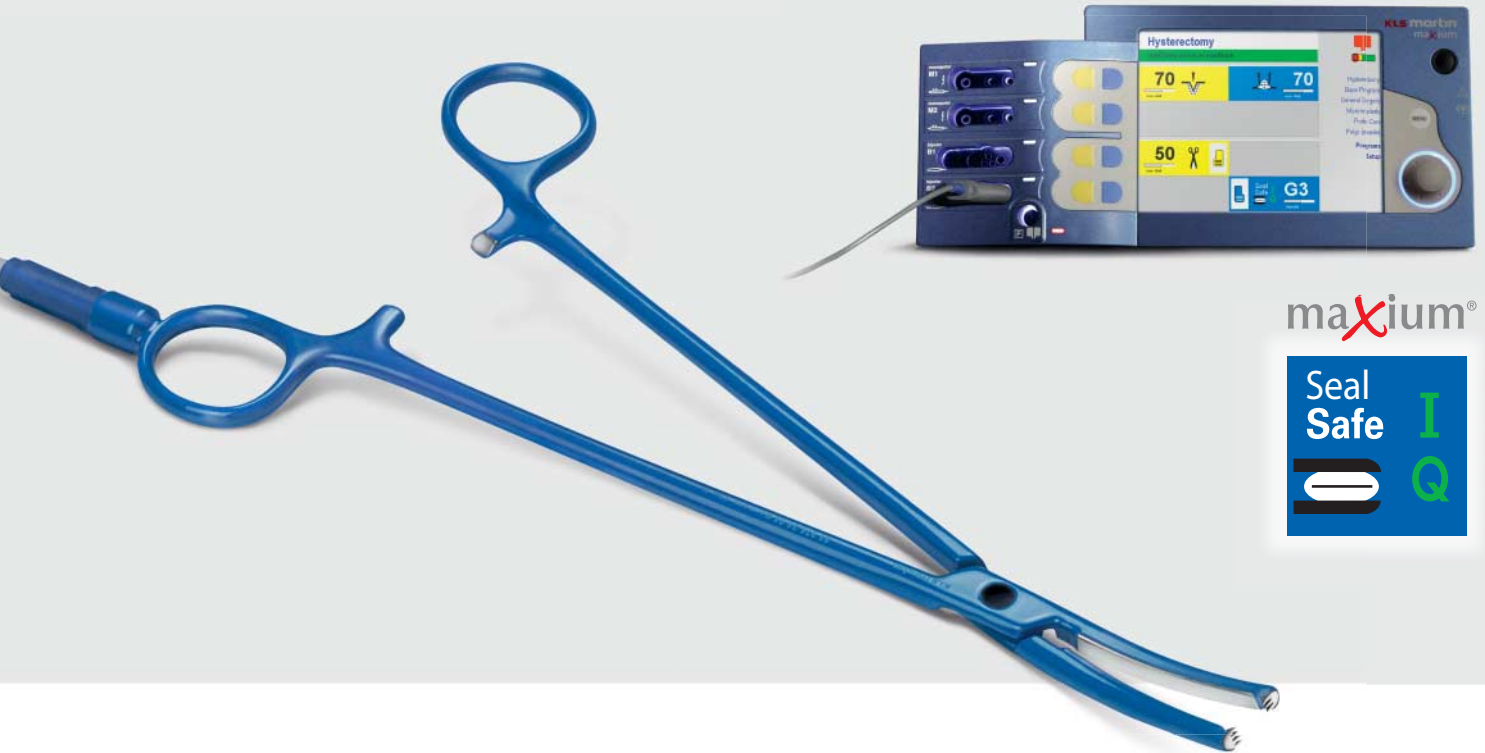

maxium®



„Shark”  
 80-976-23-04  
 23 cm / 9"  
 marClamp®



Gemini  
 80-978-23-04  
 22 cm / 8½"  
 marClamp®

Bipolare Gefäßversiegelung  
 Bipolar vessel sealing  
 Sellado vascular bipolar  
 Clampage vasculaire bipolaire  
 Sigillatura vascolare bipolare



- Präparieren
- Versiegeln
- Plug & Play**
- Wiederverwendbar

- Dissect
- Seal
- Plug & Play**
- Reusable

- Diseccionar
- Sellar
- Plug & Play**
- Reutilizable

- Disséquer
- Clamper
- Plug & Play**
- Réutilisable

- Sezionare
- Sigillare
- Plug & Play**
- Riutilizzabile

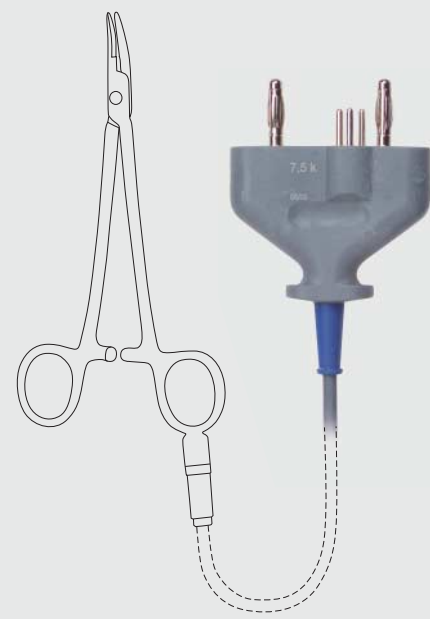

Kalem  
 80-977-23-04  
 23 cm / 9"  
 marClamp® Uro



Weitere Informationen entnehmen Sie bitte der separaten Broschüre.  
 For further information please refer to our separate product brochure.  
 Encontrará informaciones adicionales en el folleto individual.  
 Vous trouverez des informations supplémentaires dans la brochure.  
 Per ulteriori informazioni vedasi il prospetto separato.



Kombi-Instrument für die offenchirurgische Gefäßversiegelung  
 Combination instrument for open surgical vessel sealing  
 Instrumento combinado para el sellado vascular en cirugía abierta  
 Instrument combiné de scellement de vaisseaux sanguins pour la chirurgie ouverte  
 Strumento combinato per la sigillatura vascolare nella chirurgia a cielo aperto



## marClamp® CUT IQ



- |  |   |  |  |
|--|---|--|--|
| <input checked="" type="checkbox"/> Präparieren  | <input checked="" type="checkbox"/> Dissect   | <input checked="" type="checkbox"/> Diseccionar  | <input checked="" type="checkbox"/> Disséquer  |
| <input checked="" type="checkbox"/> Versiegeln   | <input checked="" type="checkbox"/> Seal  | <input checked="" type="checkbox"/> Sellar   | <input checked="" type="checkbox"/> Clamper  |
| <input checked="" type="checkbox"/> Trennen  | <input checked="" type="checkbox"/> Cut   | <input checked="" type="checkbox"/> Cortar   | <input checked="" type="checkbox"/> Couper   |
| <input checked="" type="checkbox"/> <b>Plug &amp; Play</b><br>(mit integriertem Schalter für maxium® Hardware 06, Software ab V 3.412) | <input checked="" type="checkbox"/> <b>Plug &amp; Play</b><br>(with integrated switch for maxium® hardware 06, software from V 3.412) | <input checked="" type="checkbox"/> <b>Plug &amp; Play</b><br>(con interruptor integrado para hardware maxium® 06, software a partir de V 3.412) | <input checked="" type="checkbox"/> <b>Plug &amp; Play</b><br>(avec interrupteur intégré pour hardware maxium® 06, logiciel à partir de V 3.412) |
| <input checked="" type="checkbox"/> Kein Instrumentenwechsel   | <input checked="" type="checkbox"/> No need to exchange instruments   | <input checked="" type="checkbox"/> No es necesario cambiar de instrumento   | <input checked="" type="checkbox"/> Il n'est pas nécessaire de changer d'instruments   |
| <input checked="" type="checkbox"/> Wiederverwendbar   | <input checked="" type="checkbox"/> Reusable  | <input checked="" type="checkbox"/> Reutilizable   | <input checked="" type="checkbox"/> Réutilisable   |

	marClamp®-CUT-IQ-System Instrument, komplett incl. Reinigungswerkzeug und 3 Reinigungsbürsten	marClamp® CUT IQ System Instrument, complete incl. cleaning tool and 3 cleaning brushes	Sistema marClamp® CUT IQ Instrumento, completo incl. herramienta de limpieza y 3 cepillos de limpieza
80-632-18-04	marClamp® CUT IQ, 18 cm	marClamp® CUT IQ, 18 cm	marClamp® CUT IQ, 18 cm
	Komponenten	Components	Componentes
80-632-00-04	Klinge für marClamp® CUT IQ, steril, VE=10	Blade for marClamp® CUT IQ, sterile, pack of 10	Cuchilla para marClamp® CUT IQ, estéril, UE=10
80-630-58-04	Reinigungswerkzeug	Cleaning tool	Herramienta de limpieza
80-632-01-04	Set Reinigungsbürsten, 3 Stück	Set of cleaning brushes, 3 pcs.	Juego de cepillos de limpieza, 3 unidades

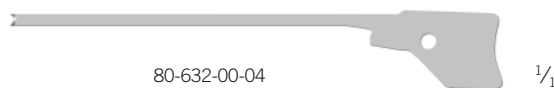
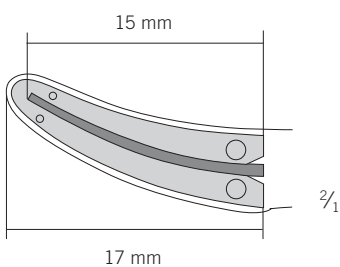
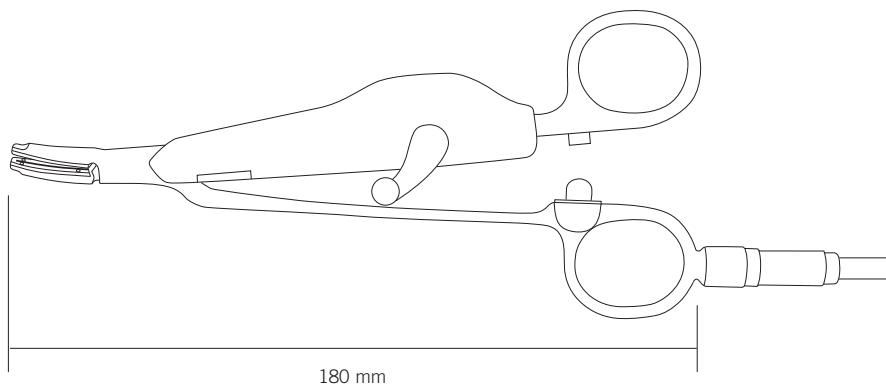



Integrierter Schalter zur Handaktivierung  
 Integrated switch for manual activation  
 Interruptor integrado para la activación manual  
 Interrupteur intégré pour l'activation manuelle  
 Interruttore integrato per l'attivazione manuale



- Sezionare
- Sigillare
- Separare
- Plug & Play**  
 (con interruttore integrato per hardware maximum® 06, software a partire di V 3.412)
- Senza necessità di cambiare strumento
- Riutilizzabile

maximum®



	Système marClamp® CUT IQ Instrument, complet incl. outil de nettoyage et 3 brosses de nettoyage	Sistema marClamp® CUT IQ Strumento, completo incl. strumento di pulizia e 3 spazzolini di pulizia
80-632-18-04	marClamp® CUT IQ, 18 cm	marClamp® CUT IQ, 18 cm
	Composants	Componenti
80-632-00-04	Lame pour instrument marClamp® CUT IQ, stérile, UC=10	Lama per marClamp® CUT IQ, sterile, confezione=10 unità
80-630-58-04	Outil de nettoyage	Strumento di pulizia
80-632-01-04	Jeu de brosses de nettoyage, 3 unités	Set di spazzolini di pulizia, 3 pezzi

„IQ“

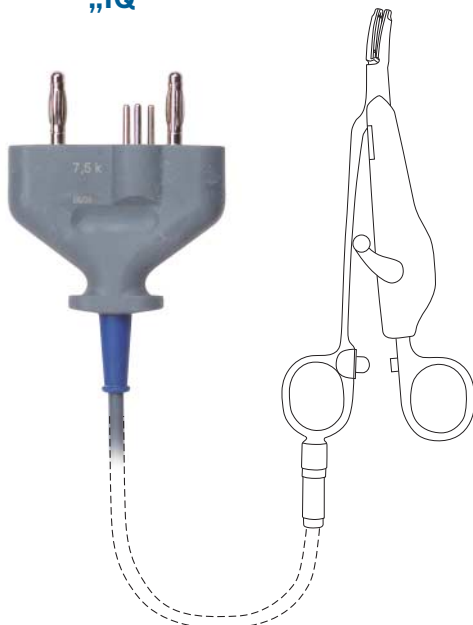

Weitere Informationen entnehmen Sie bitte der separaten Broschüre.

For further information please refer to our separate product brochure.

Encontrará informaciones adicionales en el folleto individual.

Vous trouverez des informations supplémentaires dans la brochure.

Per ulteriori informazioni vedasi il prospetto separato.

marSeal – bipolares Gefäßversiegelungssystem  
 marSeal – bipolar vessel sealing system  
 marSeal – sistema de sellado vascular bipolar  
 marSeal – système bipolaire de clamage de vaisseaux  
 marSeal – sistema bipolare di sigillatura dei vasi

**marSeal IQ**



**Convincing Precision!**

- |  |   |  |  |
|--|---|--|--|
| <input checked="" type="checkbox"/> Präparieren  | <input checked="" type="checkbox"/> Dissect   | <input checked="" type="checkbox"/> Diseccionar  | <input checked="" type="checkbox"/> Disséquer  |
| <input checked="" type="checkbox"/> Versiegeln   | <input checked="" type="checkbox"/> Seal  | <input checked="" type="checkbox"/> Sellar   | <input checked="" type="checkbox"/> Clamper  |
| <input checked="" type="checkbox"/> Trennen  | <input checked="" type="checkbox"/> Cut   | <input checked="" type="checkbox"/> Cortar   | <input checked="" type="checkbox"/> Couper   |
| <input checked="" type="checkbox"/> <b>Plug &amp; Play</b><br>(mit Fingerschaltung nur bei IQ und für maxium® Hardware 06) | <input checked="" type="checkbox"/> <b>Plug &amp; Play</b><br>(with finger switch operation only with IQ and for maxium® hardware 06) | <input checked="" type="checkbox"/> <b>Plug &amp; Play</b><br>(con control a través de interruptor manual sólo con IQ y para el hardware 06 del maxium®) | <input checked="" type="checkbox"/> <b>Plug &amp; Play</b><br>(avec commande manuelle uniquement sur IQ et pour version matérielle maxium® HW06) |
| <input checked="" type="checkbox"/> Kein Instrumentenwechsel   | <input checked="" type="checkbox"/> No need to exchange instruments   | <input checked="" type="checkbox"/> No es necesario cambiar de instrumento   | <input checked="" type="checkbox"/> Il n'est pas nécessaire de changer d'instruments   |
| <input checked="" type="checkbox"/> Wiederverwendbar   | <input checked="" type="checkbox"/> Reusable  | <input checked="" type="checkbox"/> Reutilizable   | <input checked="" type="checkbox"/> Réutilisable   |

	marSeal-System Instrument, komplett incl. 6 Klingen, Reinigungswerkzeug und Spüladapter	marSeal System Instrument, complete incl. 6 blades, cleaning tool and flushing adapter	Sistema marSeal Instrumento, completo incl. 6 hojas, herramienta de limpieza y adaptador de enjuague
80-630-41-04	„IQ“-Version	Version „IQ“	Versión „IQ“
80-630-01-04	„m“-Version	Version „m“	Versión „m“
80-630-03-04	„i“-/„e“-Version	Version „i“/„e“	Versión „i“/ „e“
	Komponenten	Components	Componentes
80-630-45-04	Handgriff „IQ“	Handle „IQ“	Mango „IQ“
80-630-08-04	Handgriff „m“-Version	Handle „m“	Mango „m“
80-630-09-04	Handgriff „i“-/„e“-Version	Handle „i“/„e“	Mango „i“/ „e“
80-630-12-04	Rohrschaft *	Tubular shaft *	Vástago de tubo *
80-630-15-04	Klinge zum Einmalgebrauch, VE = 6 Stck.	Disposable blade, SU = 6/pack	Hoja desechable, UV = 6 piezas
80-630-17-04	Reinigungswerkzeug	Cleaning tool	Herramienta de limpieza
80-630-18-04	Spüladapter	Flushing adapter	Adaptador de enjuague

\* incl. 80-630-17-04, 80-630-18-04

\* incl. 80-630-17-04, 80-630-18-04

\* incl. 80-630-17-04, 80-630-18-04

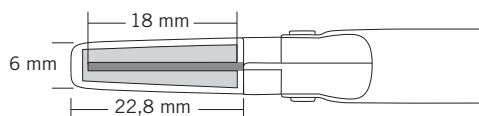

Über Fingerschaltung aktivierbar  
 Can be activated via finger switch operation  
 Puede activarse a través de interruptor manual  
 Activable par commande manuelle  
 Attivazione tramite l'interruttore manuale



- Sezionare
- Sigillare
- Separare
- Plug & Play**  
 (con interruttore manuale solo per IQ e per maxium® con versione hardware 06)
- Senza necessità di cambiare strumento
- Riutilizzabile

maxium®



	Système marSeal Instrument, complet incl. 6 lames, outil de nettoyage et adaptateur de rinçage	Sistema marSeal Strumento, completo incl. 6 lame, strumenti di pulizia e adattatore di lavaggio
80-630-41-04	Version «IQ»	Versione "IQ"
80-630-01-04	Version «m»	Versione "m"
80-630-03-04	Version «i» / «e»	Versione "i" / "e"
	Composants	Componenti
80-630-45-04	Manche «IQ»	Impugnatura "IQ"
80-630-08-04	Manche «m»	Impugnatura "m"
80-630-09-04	Manche «i» / «e»	Impugnatura versione "i" / "e"
80-630-12-04	Tige tubulaire *	Guaina tubo *
80-630-15-04	Lame à usage unique, UC = 6 unités	Lama monouso, UV = 6 pezzi
80-630-17-04	Outil de nettoyage	Strumenti di pulizia
80-630-18-04	Adaptateur de rinçage	Adattatore di lavaggio

\* incl. 80-630-17-04, 80-630-18-04

\* incl. 80-630-17-04, 80-630-18-04

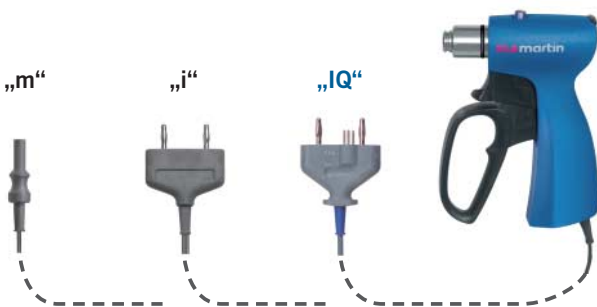

4 m/13 ft.



Weitere Informationen entnehmen Sie bitte der separaten Broschüre.

For further information please refer to our separate product brochure.

Encontrará informaciones adicionales en el folleto individual.

Vous trouverez des informations supplémentaires dans la brochure.

Per ulteriori informazioni vedasi il prospetto separato.

marSeal Slim – bipolares Gefäßversiegelungssystem  
 marSeal Slim – bipolar vessel sealing system  
 marSeal Slim – sistema de sellado vascular bipolar  
 marSeal Slim – système bipolaire de clampage de vaisseaux  
 marSeal Slim – sistema bipolare di sigillatura dei vasi

**marSeal Slim IQ**



**Convincing Precision!**

- |  |   |  |  |
|--|---|--|--|
| <input checked="" type="checkbox"/> Präparieren  | <input checked="" type="checkbox"/> Dissect   | <input checked="" type="checkbox"/> Diseccionar  | <input checked="" type="checkbox"/> Disséquer  |
| <input checked="" type="checkbox"/> Versiegeln   | <input checked="" type="checkbox"/> Seal  | <input checked="" type="checkbox"/> Sellar   | <input checked="" type="checkbox"/> Clamper  |
| <input checked="" type="checkbox"/> Trennen  | <input checked="" type="checkbox"/> Cut   | <input checked="" type="checkbox"/> Cortar   | <input checked="" type="checkbox"/> Couper   |
| <input checked="" type="checkbox"/> <b>Plug &amp; Play</b><br>(mit Fingerschaltung<br>nur bei IQ und für<br>maxium® Hardware 06) | <input checked="" type="checkbox"/> <b>Plug &amp; Play</b><br>(with finger switch operation<br>only with IQ and for maxium®<br>hardware 06) | <input checked="" type="checkbox"/> <b>Plug &amp; Play</b><br>(con control a través de interruptor<br>manual sólo con IQ y para el<br>hardware 06 del maxium®) | <input checked="" type="checkbox"/> <b>Plug &amp; Play</b><br>(avec commande manuelle<br>uniquement sur IQ et pour version<br>matérielle maxium® HW06) |
| <input checked="" type="checkbox"/> Kein Instrumenten-<br>wechsel  | <input checked="" type="checkbox"/> No need to exchange<br>instruments  | <input checked="" type="checkbox"/> No es necesario cambiar<br>de instrumento  | <input checked="" type="checkbox"/> Il n'est pas nécessaire de<br>changer d'instruments  |
| <input checked="" type="checkbox"/> Wiederverwendbar   | <input checked="" type="checkbox"/> Reusable  | <input checked="" type="checkbox"/> Reutilizable   | <input checked="" type="checkbox"/> Réutilisable   |

	marSeal-Slim-System Instrument, komplett incl. 6 Klengen, Reinigungswerkzeug und Spüladapter	marSeal Slim System Instrument, complete incl. 6 blades, cleaning tool and flushing adapter	Sistema marSeal Slim Instrumento, completo incl. 6 hojas, herramienta de limpieza y adaptador de enjuague
80-630-42-04	„IQ“-Version, Schaftlänge 370 mm	Version “IQ”, shaft length 370 mm	Versión “IQ”, longitud de vástago 370 mm
80-630-43-04	„IQ“-Version, Schaftlänge 200 mm	Version “IQ”, shaft length 200 mm	Versión “IQ”, longitud de vástago 200 mm
80-630-30-04	„m“-Version, Schaftlänge 370 mm	Version “m”, shaft length 370 mm	Versión “m”, longitud de vástago 370 mm
80-630-32-04	„m“-Version, Schaftlänge 200 mm	Version “m”, shaft length 200 mm	Versión “m”, longitud de vástago 200 mm
80-630-31-04	„i“-/„e“-Version, Schaftlänge 370 mm	Version “i”/“e”, shaft length 370 mm	Versión “i”/ “e”, longitud de vástago 370 mm
80-630-33-04	„i“-/„e“-Version, Schaftlänge 200 mm	Version “i”/“e”, shaft length 200 mm	Versión “i”/ “e”, longitud de vástago 200 mm
	Komponenten	Components	Componentes
80-630-45-04	Handgriff „IQ“	Handle “IQ”	Mango “IQ”
80-630-08-04	Handgriff „m“-Version	Handle “m”	Mango “m”
80-630-09-04	Handgriff „i“-/„e“-Version	Handle “i”/“e”	Mango “i”/ “e”
80-630-34-04	Rohrschaft, Länge 370 mm *	Tubular shaft, 370 mm long*	Vástago de tubo, longitud 370 mm *
80-630-35-04	Rohrschaft, Länge 200 mm *	Tubular shaft, 200 mm long*	Vástago de tubo, longitud 200 mm *
80-630-15-04	Klinge zum Einmalgebrauch, VE=6 Stck.	Disposable blade, SU=6/pack	Hoja desechable, UV = 6 piezas
80-630-17-04	Reinigungswerkzeug	Cleaning tool	Herramienta de limpieza
80-630-18-04	Spüladapter	Flushing adapter	Adaptador de enjuague

\* inkl. 80-630-17-04, 80-630-18-04

\* incl. 80-630-17-04, 80-630-18-04

\* incl. 80-630-17-04, 80-630-18-04

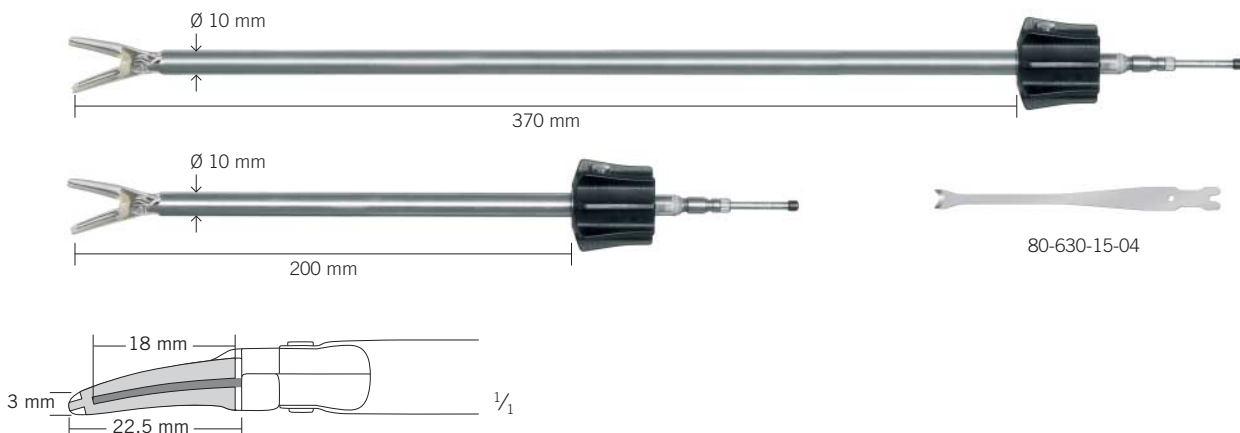



Über Fingerschaltung aktivierbar  
 Can be activated via finger switch operation  
 Puede activarse a través de interruptor manual  
 Activable par commande manuelle  
 Attivazione tramite l'interruttore manuale



maxium®



- Sezionare
- Sigillare
- Separare
- Plug & Play**  
 (con interruttore manuale solo per IQ e per maxium® con versione hardware 06)
- Senza necessità di cambiare strumento
- Riutilizzabile

	Système marSeal Slim Instrument, complet incl. 6 lames, outil de nettoyage et adaptateur de rinçage	Sistema marSeal Slim Strumento, completo incl. 6 lame, strumenti di pulizia e adattatore di lavaggio
80-630-42-04	Version «IQ», longueur de tige 370 mm	Versione "IQ", lunghezza guaina 370 mm
80-630-43-04	Version «IQ», longueur de tige 200 mm	Versione "IQ", lunghezza guaina 200 mm
80-630-30-04	Version «m», longueur de tige 370 mm	Versione "m", lunghezza guaina 370 mm
80-630-32-04	Version «m», longueur de tige 200 mm	Versione "m", lunghezza guaina 200 mm
80-630-31-04	Version «i» / «e», longueur de tige 370 mm	Versione "i" / "e", lunghezza guaina 370 mm
80-630-33-04	Version «i» / «e», longueur de tige 200 mm	Versione "i" / "e", lunghezza guaina 200 mm
	Composants	Componenti
80-630-45-04	Manche «IQ»	Impugnatura "IQ"
80-630-08-04	Manche «m»	Impugnatura "m"
80-630-09-04	Manche «i» / «e»	Impugnatura versione "i" / "e"
80-630-34-04	Tige tubulaire, longueur 370 mm *	Lunghezza guaina tubo 370 mm *
80-630-35-04	Tige tubulaire, longueur 200 mm *	Lunghezza guaina tubo 200 mm *
80-630-15-04	Lame à usage unique, UC = 6 unités	Lama monouso, UV = 6 pezzi
80-630-17-04	Outil de nettoyage	Strumenti di pulizia
80-630-18-04	Adaptateur de rinçage	Adattatore di lavaggio

\* incl. 80-630-17-04, 80-630-18-04

\* incl. 80-630-17-04, 80-630-18-04

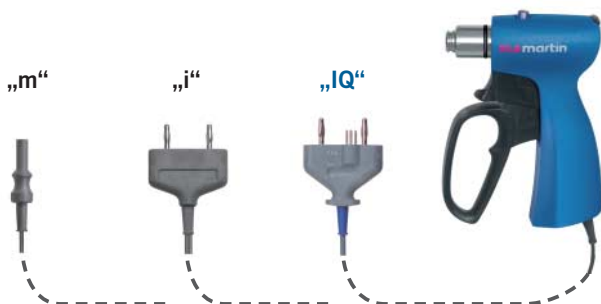

4 m/13 ft.



Weitere Informationen entnehmen Sie bitte der separaten Broschüre.

For further information please refer to our separate product brochure.

Encontrará informaciones adicionales en el folleto individual.

Vous trouverez des informations supplémentaires dans la brochure.

Per ulteriori informazioni vedasi il prospetto separato.

marSeal 5 – bipolares Gefäßversiegelungssystem  
 marSeal 5 – bipolar vessel sealing system  
 marSeal 5 – sistema de sellado vascular bipolar  
 marSeal 5 – système bipolaire de clampage de vaisseaux  
 marSeal 5 – sistema bipolare di sigillatura dei vasi



## marSeal 5 IQ & marSeal 5 IQ short



### Convincing Precision!

- |  |   |  |  |
|--|---|--|--|
| <input checked="" type="checkbox"/> Präparieren  | <input checked="" type="checkbox"/> Dissect   | <input checked="" type="checkbox"/> Diseccionar  | <input checked="" type="checkbox"/> Disséquer  |
| <input checked="" type="checkbox"/> Versiegeln   | <input checked="" type="checkbox"/> Seal  | <input checked="" type="checkbox"/> Sellar   | <input checked="" type="checkbox"/> Clamper  |
| <input checked="" type="checkbox"/> Trennen  | <input checked="" type="checkbox"/> Cut   | <input checked="" type="checkbox"/> Cortar   | <input checked="" type="checkbox"/> Couper   |
| <input checked="" type="checkbox"/> <b>Plug &amp; Play</b><br>(mit Fingerschaltung<br>nur bei IQ und für<br>maxium® Hardware 06) | <input checked="" type="checkbox"/> <b>Plug &amp; Play</b><br>(with finger switch operation<br>only with IQ and for maxium®<br>hardware 06) | <input checked="" type="checkbox"/> <b>Plug &amp; Play</b><br>(con control a través de interruptor<br>manual sólo con IQ y para el<br>hardware 06 del maxium®) | <input checked="" type="checkbox"/> <b>Plug &amp; Play</b><br>(avec commande manuelle<br>uniquement sur IQ et pour version<br>matérielle maxium® HW06) |
| <input checked="" type="checkbox"/> Kein Instrumenten-<br>wechsel  | <input checked="" type="checkbox"/> No need to exchange<br>instruments  | <input checked="" type="checkbox"/> No es necesario cambiar<br>de instrumento  | <input checked="" type="checkbox"/> Il n'est pas nécessaire de<br>changer d'instruments  |
| <input checked="" type="checkbox"/> Wiederverwendbar   | <input checked="" type="checkbox"/> Reusable  | <input checked="" type="checkbox"/> Reutilizable   | <input checked="" type="checkbox"/> Réutilisable   |

	marSeal-5-System Instrument, komplett incl. Klingenträger, Reinigungswerkzeug und Spüladapter	marSeal 5 System Instrument, complete incl. blade rod, cleaning tool and flushing adapter	Sistema marSeal 5 Instrumento, completo incl. soporte, herramienta de limpieza y adaptador de enjuague
80-630-50-04	„IQ“-Version, Schaftlänge 370 mm	Version „IQ“, shaft length 370 mm	Versión „IQ“, longitud de vástago 370 mm
80-630-90-04	„IQ“-Version short, Schaftlänge 200 mm	Version „IQ“ short, shaft length 200 mm	Versión „IQ“ short, longitud de vástago 200 mm
80-630-54-04	„m“-Version, Schaftlänge 370 mm	Version „m“, shaft length 370 mm	Versión „m“, longitud de vástago 370 mm
80-630-55-04	„i“/„e“-Version, Schaftlänge 370 mm	Version „i“/„e“, shaft length 370 mm	Versión „i“/ „e“, longitud de vástago 370 mm
	Komponenten	Components	Componentes
80-630-52-04	Handgriff „IQ“	Handle „IQ“	Mango „IQ“
80-630-56-04	Handgriff „m“-Version	Handle „m“ version	Mango „m“
80-630-57-04	Handgriff „i“/„e“-Version	Handle „i“/„e“ version	Mango „i“/ „e“
80-630-51-04	Rohrschaft, Länge 370 mm*	Tubular shaft, 370 mm long*	Vástago tubular, longitud 370 mm*
80-630-92-04	Rohrschaft für marSeal 5 IQ short, Länge 200 mm*	Tubular shaft for marSeal 5 IQ short, 200 mm*	Vástago tubular para marSeal 5 IQ short, longitud 200 mm*
80-630-53-04	Klingenträger, Länge 370 mm, zum Einmalgebrauch, VE = 6 Stck.	Disposable blade rod, 370 mm long, SU = 6/pack	Soporte desechable, longitud 370 mm, UE = 6 unidades
80-630-91-04	Klingenträger für marSeal 5 IQ short, Länge 200 mm, zum Einmalgebrauch, VE = 6 Stck.	Disposable blade rod for marSeal 5 IQ short, 200 mm long, U = 6/pack	Soporte desechable para marSeal 5 IQ short, longitud 200 mm, UE = 6 unidades
80-630-83-04	Klingenträger zum Einmalgebrauch, steril, Länge 370 mm, VE = 10 Stck.	Disposable blade rod, sterile, 370 mm long, SU = 10/pack	Soporte desechable, estéril longitud 370 mm, UE = 10 unidades
80-630-58-04	Reinigungswerkzeug	Cleaning tool	Herramienta de limpieza
80-630-59-04	Spüladapter	Flushing adapter	Adaptador de enjuague

\* inkl. 80-630-58-04, 80-630-59-04

\* incl. 80-630-58-04, 80-630-59-04

\* incl. 80-630-58-04, 80-630-59-04



Über Fingerschaltung aktivierbar  
 Can be activated via finger switch operation  
 Puede activarse a través de interruptor manual  
 Activable par commande manuelle  
 Attivazione tramite l'interruttore manuale



- Sezionare
- Sigillare
- Separare
- Plug & Play**  
 (con interruttore manuale solo per IQ e per maxium® con versione hardware 06)
- Senza necessità di cambiare strumento
- Riutilizzabile

maxium®



	<b>Système marSeal 5</b> Instrument, complet incl. Porte-lame, outil de nettoyage et adaptateur de rinçage	<b>Sistema marSeal 5</b> Strumento, completo incl. portalama, strumenti di pulizia e adattatore di lavaggio
80-630-50-04	Version «IQ», longueur de tige 370 mm	Versione "IQ", lunghezza guaina 370 mm
80-630-90-04	Version «IQ» short, longueur de tige 200 mm	Versione "IQ" short, lunghezza guaina 200 mm
80-630-54-04	Version «m», longueur de tige 370 mm	Versione "m", lunghezza guaina 370 mm
80-630-55-04	Version «i»/«e», longueur de tige 370 mm	Versione "i"/"e", lunghezza guaina 370 mm
	<b>Composants</b>	<b>Componenti</b>
80-630-52-04	Poignée «IQ»	Impugnatura "IQ"
80-630-56-04	Poignée «m»	Impugnatura "m"
80-630-57-04	Poignée «i»/«e»	Impugnatura "i"/"e"
80-630-51-04	Tige tubulaire marSeal 5, longueur 370 mm*	Lunghezza guaina tubo 370 mm*
80-630-92-04	Tige tubulaire pour marSeal 5 IQ short, longueur 200 mm*	Lunghezza guaina tubo 200 mm per marSeal 5 IQ short *
80-630-53-04	Porte-lame à usage unique, longueur 370 mm, UE = 6 pièces	Portalama monouso, lunghezza 370 mm, UV = 6 pezzi
80-630-91-04	Porte-lame à usage unique pour marSeal 5 IQ short, longueur 200 mm, UE = 6 pièces	Portalama monouso per marSeal 5 IQ short, lunghezza 200 mm, UV = 6 pezzi
80-630-83-04	Porte-lame à usage unique, stérile longueur 370 mm, UE = 10 pièces	Portalama monouso, stérilmente lunghezza 370 mm, UV = 10 pezzi
80-630-58-04	Outil de nettoyage	Strumento di pulizia
80-630-59-04	Adaptateur de rinçage	Adattatore di lavaggio

\* incl. 80-630-58-04, 80-630-59-04

\* incl. 80-630-58-04, 80-630-59-04

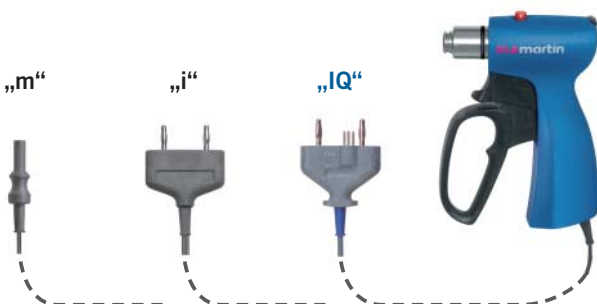

4 m/13 ft.



Weitere Informationen entnehmen Sie bitte der separaten Broschüre.

For further information please refer to our separate product brochure.

Encontrará informaciones adicionales en el folleto individual.

Vous trouverez des informations supplémentaires dans la brochure.

Per ulteriori informazioni vedasi il prospetto separato.





MONOPOLARE ANSCHLUSSKABEL UND ADAPTER  
MONOPOLAR CONNECTION CABLES AND ADAPTER  
CABLES DE CONEXIÓN MONOPOLARES Y ADAPTADORES  
CÂBLES DE RACCORDEMENT MONOPOLAIRES ET ADAPTATEURS  
CAVI DI CONNESSIONE MONOPOLARI E ADATTATORI

91-107

BIPOLARE ANSCHLUSSKABEL UND ADAPTER  
BIPOLAR CONNECTION CABLES AND ADAPTER  
CABLES DE CONEXIÓN BIPOLARES Y ADAPTADORES  
CÂBLES DE RACCORDEMENT BIPOLAIRES ET ADAPTATEURS  
CAVI DI CONNESSIONE BIPOLARI E ADATTATORI

Monopolare Anschlusskabel  
 Monopolar connection cables  
 Cables de conexión monopolares  
 Câbles de raccordement monopolaires  
 Cavi di connessione monopolari

max. 4000 V<sub>p</sub>



80-289-40-04  
 4 m/13 ft.  
 KLS-Martin-Geräte  
 → Instrumente mit 3-mm-Stecker (Olympus)  
 KLS Martin units  
 → instruments with 3-mm plug (Olympus)  
 equipos de KLS Martin  
 → instrumentos con clavija de 3 mm (Olympus)  
 appareils KLS Martin  
 → instruments avec fiche de 3 mm (Olympus)  
 apparecchi di KLS Martin  
 → strumenti con spina da 3 mm (Olympus)



83-120-50-04  
 5 m/16 ft.  
 KLS-Martin-Geräte  
 → Instrumente mit 4-mm-Stecker  
 KLS Martin units  
 → instruments with 4-mm plug  
 equipos de KLS Martin  
 → instrumentos con clavija de 4 mm  
 appareils KLS Martin  
 → instruments avec fiche de 4 mm  
 apparecchi di KLS Martin  
 → strumenti con spina da 4 mm

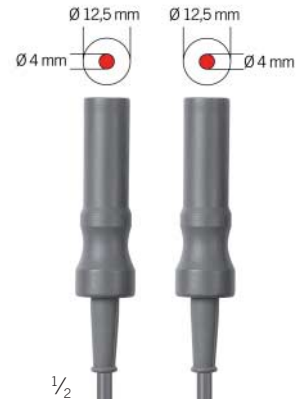

80-285-40-04    80-285-50-04  
 4 m/13 ft.        5 m/16 ft.  
 KLS-Martin-Geräte  
 → für Isolit-Pinzetten  
 KLS Martin units  
 → for Isolit forceps  
 aparatos KLS Martin  
 → para pinzas Isolit  
 appareils KLS Martin  
 → pour des pinces Isolit  
 apparecchi KLS Martin  
 → per pinze Isolit



80-289-42-04  
 4 m/13 ft.  
 maxium® „e“-Version und Erbe-, ICC-, ACC- und VIO-Geräte  
 → Instrumente mit 3-mm-Anschluss (Olympus)  
 maxium® “e”-version and Erbe, ICC, ACC and VIO units  
 → Instruments with 3-mm socket (Olympus)  
 maxium® versión “e” y Erbe, ICC, ACC y VIO  
 → Instrumentos con conexión de Ø 3 mm (Olympus)  
 maxium® version «e» et Erbe, ICC, ACC et VIO  
 → Instruments avec prise de Ø 3 mm (Olympus)  
 maxium® versione “e” e Erbe, ICC, ACC e VIO  
 → Strumenti con presa da Ø 3 mm (Olympus)



83-122-60-04  
 6 m/20 ft.  
 maxium® „e“-Version und Erbe-, ICC-, ACC- und VIO-Geräte  
 → Instrumente mit 4-mm-Anschluss  
 maxium® “e”-version and Erbe, ICC, ACC and VIO units  
 → Instruments with 4-mm socket  
 maxium® versión “e” y Erbe, ICC, ACC y VIO  
 → Instrumentos con conexión de Ø 4 mm  
 maxium® version «e» et Erbe, ICC, ACC et VIO  
 → Instruments avec prise de Ø 4 mm  
 maxium® versione “e” e Erbe, ICC, ACC e VIO  
 → Strumenti con presa da Ø 4 mm



83-122-50-04  
 5 m/16 ft.  
 Erbotom-Geräte  
 → Instrumente mit 4-mm-Anschluss  
 Erbotom electrosurgical units  
 → Instruments with 4-mm socket  
 aparatos Erbotom  
 → instrumentos con conexión de Ø 4 mm  
 appareils Erbotom  
 → instruments avec prise de Ø 4 mm  
 apparecchi Erbotom  
 → strumenti con presa da Ø 4 mm



max. 4000 V<sub>p</sub>



80-285-55-04

4 m/13 ft.

mit 3-Pin-Stecker  
 → für Isolit-Pinzetten

cable with 3-pin plug  
 → for Isolit forceps

con clavija de 3 patillas  
 → para pinzas Isolit

avec fiche à 3-broches  
 → pour des pinces Isolit

monopolare con spina a 3-spire  
 → per pinze Isolit

Olympus



80-289-41-04

4 m/13 ft.

mit 3-Pin-Stecker → Instrumente  
 mit 3-mm-Stecker (Olympus)

cable with 3-pin plug → Instruments  
 with 3-mm plug (Olympus)

con clavija de 3 patillas → Instrumentos  
 con clavija de Ø 3 mm (Olympus)

avec fiche à 3-broches → Instruments  
 avec fiche de Ø 3 mm (Olympus)

monopolare con spina a 3-spire →  
 Strumenti con spina da Ø 3 mm (Olympus)



80-290-40-04

4 m/13 ft.

KLS-Martin-Geräte  
 → Instrumente mit 3,2-mm-Stecker

KLS Martin units  
 → Instruments with 3.2-mm plug

aparatos KLS Martin  
 → Instrumentos con clavija de Ø 3,2 mm

appareils KLS Martin  
 → Instruments avec fiche de Ø 3,2 mm

apparecchi KLS Martin  
 → Strumenti con spina da Ø 3,2 mm



83-120-51-04

5 m/16 ft.

3-Pin-Stecker  
 → Instrumente mit 4-mm-Stecker

3-pin plug  
 → Instruments with 4-mm plug

clavija de 3 patillas  
 → Instrumentos con clavija de Ø 4 mm

fiche à 3-broches  
 → Instruments avec fiche de Ø 4 mm

spina a 3-spire  
 → Strumenti con spina da Ø 4 mm



83-124-50-04

5 m/16 ft.

maxium® „i“-Version, ME MB 3 „i“, ME MB 2 „i“ und  
 Valleylab-Geräte → MIC-Instrumente mit 4-mm-Anschluss

maxium® „i“-version, ME MB 3 „i“, ME MB 2 „i“ and  
 Valleylab units → MIS Instruments with 4-mm socket

maxium® versión „i“, ME MB 3 „i“, ME MB 2 „i“ y  
 aparatos Valleylab → Instrumentos para la cirugía  
 mínima invasiva con conexión de Ø 4 mm

maxium® version «i», ME MB 3 «i», ME MB 2 «i» et  
 appareils Valleylab → Instruments pour la chirurgie  
 non-invasive avec prise de Ø 4 mm

maxium® versione „i“, ME MB 2 „i“, ME MB 2 „i“ e  
 apparecchi Valleylab → Strumenti per la chirurgia  
 mininvasiva con presa da Ø 4 mm



83-124-52-04

4 m/13 ft.

maxium® „i“-Version, ME MB 3 „i“, ME MB 2 „i“ und  
 Valleylab-Geräte → für Isolit-Pinzetten

maxium® „i“-version, ME MB 3 „i“, ME MB 2 „i“ and  
 Valleylab units → for Isolit forceps

maxium® versión „i“, ME MB 3 „i“, ME MB 2 „i“ y  
 aparatos Valleylab → para pinzas Isolit

maxium® version «i», ME MB 3 «i», ME MB 2 «i» et  
 appareils Valleylab → pour des pinces Isolit

maxium® versione „i“, ME MB 2 „i“, ME MB 2 „i“ e  
 apparecchi Valleylab → per pinze Isolit

NON-CE



80-280-30-04

3 m/10 ft.

Anschlusskabel, einpolig,  
 für Griff 80-213-01-04

Connection cable, monopolar,  
 for handle 80-213-01-04

Cable de conexión, monopolar,  
 para mango 80-213-01-04

Câble de raccordement, monopolaire,  
 pour manche 80-213-01-04

Cavo di connessione, monopolare,  
 per manico 80-213-01-04

Anschlusskabel für monopolare Resektoskope  
 Connecting cables for monopolar resectoscopes  
 Cables de conexión para resectoscopios monopolares  
 Câbles de raccordement pour résectoscopes monopolaires  
 Cavi di collegamento per resettoscopi monopolari

max. 4000 V<sub>p</sub>



80-286-94-04  
 4 m/13 ft.  
 3-Pin-Stecker  
 → Olympus-Resektoskope  
 3-pin plug  
 → Olympus resectoscopes  
 clavija de 3 patillas  
 → resectoscopios Olympus  
 fiche à 3-broches  
 → résectoscopes Olympus  
 con spina a 3-spire  
 → resettoscopi Olympus



80-286-95-04  
 4 m/13 ft.  
 3-Pin-Stecker  
 → Richard-Wolf-Resektoskope  
 3-pin plug  
 → Richard Wolf resectoscopes  
 clavija de 3 patillas  
 → resectoscopios Richard Wolf  
 fiche à 3-broches  
 → résectoscopes Richard Wolf  
 spina a 3-spire  
 → resettoscopi Richard Wolf



80-286-96-04  
 4 m/13 ft.  
 3-Pin-Stecker  
 → Karl-Storz-Resektoskope  
 3-pin plug  
 → Karl Storz resectoscopes  
 clavija de 3 patillas  
 → resectoscopios Karl Storz  
 fiche à 3-broches  
 → résectoscopes Karl Storz  
 spina a 3-spire  
 → resettoscopi Karl Storz





80-287-33-04 80-287-53-04 **max. 600 V<sub>p</sub>**  
 3 m/10 ft. 5 m/16 ft.

KLS-Martin-, Berchtold- und Aesculap-Geräte  
 → bipolare Instrumente

KLS Martin, Berchtold and Aesculap units  
 → bipolar instruments

Aparatos KLS Martin, Berchtold y Aesculap  
 → instrumentos bipolares

Câble de raccordement pour instruments bipolaires  
 → instruments bipolaires

Apparecchi KLS Martin, Berchtold e Aesculap  
 → strumenti bipolari



80-287-60-04 **max. 600 V<sub>p</sub>**  
 4 m/13 ft.

KLS-Martin-, Berchtold- und Aesculap-Geräte  
 → bipolare Instrumente

KLS Martin, Berchtold and Aesculap units  
 → bipolar instruments

Aparatos KLS Martin, Berchtold y Aesculap  
 → instrumentos bipolares

Câble de raccordement pour instruments bipolaires  
 → instruments bipolaires

Apparecchi KLS Martin, Berchtold e Aesculap  
 → strumenti bipolari



80-287-42-04 **max. 600 V<sub>p</sub>**  
 5 m/16 ft.

KLS-Martin-Geräte  
 → Storz bipolare Instrumente

KLS Martin units  
 → Storz bipolar instruments

KLS Martin  
 → Instrumentos bipolares Storz

appareils KLS Martin  
 → Instruments bipolaires Storz

apparecchi KLS Martin  
 → Strumenti bipolari Storz



80-285-51-04 **max. 500 V<sub>p</sub>**  
 4 m/13 ft.

KLS-Martin-Geräte  
 → Storz-Endoskope

KLS Martin units  
 → Storz endoscopes

Aparatos KLS Martin/  
 → Endoscopios Storz

Appareils KLS Martin/  
 → Endoscopes Storz

Apparecchi KLS Martin/  
 → Endoscopi Storz



80-288-53-04 **max. 600 V<sub>p</sub>**  
 5 m/16 ft.

KLS-Martin-Geräte  
 → Valleylab bipolare Pinzetten

KLS Martin units  
 → Valleylab bipolar forceps

KLS Martin  
 → Pinzas bipolares Valleylab

appareils KLS Martin  
 → Pincas bipolaires Valleylab

apparecchi KLS Martin  
 → Pinze bipolari Valleylab



80-288-55-04 **max. 600 V<sub>p</sub>**  
 5 m/16 ft.

KLS-Martin-Geräte  
 → bipolare Scheren von Ethicon (PowerStar)

KLS Martin units  
 → bipolar scissors made by Ethicon (PowerStar)

Equipos KLS Martin  
 → tijeras bipolares de Ethicon (PowerStar)

Appareils KLS Martin  
 → ciseaux bipolaires de Ethicon (PowerStar)

Apparecchi KLS Martin,  
 → forbici bipolari di marca Ethicon (PowerStar)

Bipolare Anschlusskabel  
 Bipolar connection cables  
 Cables de conexión bipolares  
 Câbles de raccordement bipolaires  
 Cavi di connessione bipolari

max. 600 V<sub>p</sub>



80-286-30-04 3 m/10 ft.  
 maxium® „e“-Version/Erbe-Geräte ICC und ACC/VIO  
 → bipolare Instrumente  
 maxium® "e"-version/ICC and ACC/VIO Erbe units  
 → bipolar instruments  
 maxium® versión "e"/aparatos Erbe ICC e ACC/VIO  
 → instrumentos bipolares  
 maxium® version «e»/appareils Erbe ICC et ACC/VIO  
 → instruments bipolaires  
 maxium® versione "e"/apparecchi Erbe ICC e ACC/VIO  
 → strumenti bipolari



80-286-60-04 4 m/13 ft.  
 maxium® „e“-Version/Erbe-Geräte ICC und ACC/VIO  
 → bipolare Instrumente  
 maxium® "e"-version/ICC and ACC/VIO Erbe units  
 → bipolar instruments  
 maxium® versión "e"/aparatos Erbe ICC e ACC/VIO  
 → instrumentos bipolares  
 maxium® version «e»/appareils Erbe ICC et ACC/VIO  
 → instruments bipolaires  
 maxium® versione "e"/apparecchi Erbe ICC e ACC/VIO  
 → strumenti bipolari

NON-CE



80-287-70-04 5 m/16 ft.  
 Codman- und Valleylab-Geräte  
 → bipolare Instrumente  
 Codman and Valleylab units  
 → bipolar instruments  
 aparatos Codman y Valleylab  
 → instrumentos bipolares  
 appareils Codman et Valleylab  
 → instruments bipolaires  
 apparecchi Codman e Valleylab  
 → strumenti bipolari



80-287-72-04 5 m/16 ft.  
 Codman- und Valleylab-Geräte  
 → bipolare Instrumente  
 Codman and Valleylab units  
 → bipolar instruments  
 aparatos Codman y Valleylab  
 → instrumentos bipolares  
 appareils Codman et Valleylab  
 → instruments bipolaires  
 apparecchi Codman e Valleylab  
 → strumenti bipolari



80-287-44-04 5 m/16 ft.  
 Geräte mit 2-Pin-International  
 → Storz bipolare Instrumente  
 units with 2-pin international  
 → Storz bipolar instruments  
 Equipos internacional con 2 alfileres,  
 → Instrumentos bipolares Storz  
 Appareils international à 2 broches  
 → Instruments bipolaires Storz  
 apparecchi internazionale a 2 pin  
 → Strumenti bipolari Storz



80-288-57-04 5 m/16 ft.  
 Geräte mit 2-Pin-International  
 → bipolare Scheren von Ethicon (PowerStar)  
 units with 2-pin international  
 → bipolar scissors made by Ethicon (PowerStar)  
 Equipos internacional con 2 alfileres,  
 → tijeras bipolares de Ethicon (PowerStar)  
 Appareils international à 2 broches  
 → ciseaux bipolaires de Ethicon (PowerStar)  
 apparecchi internazionale a 2 pin  
 → forbici bipolari di marca Ethicon (PowerStar)



max. 600 V<sub>p</sub>



80-287-80-04

4 m/13 ft.

KLS-Martin-, Berchtold- und Aesculap-Geräte  
 → Aesculap bipolare Instrumente

KLS Martin, Berchtold and Aesculap units  
 → Aesculap bipolar instruments

Aparatos KLS Martin, Berchtold y Aesculap  
 → instrumentos bipolares Aesculap

Câble de raccordement pour instruments bipolaires  
 → instruments bipolaires Aesculap

Apparecchi KLS Martin, Berchtold e Aesculap  
 → strumenti bipolari Aesculap



80-286-80-04

4 m/13 ft.

maxium® „e“-Version/Erbe-Geräte ICC und ACC/VIO  
 → Aesculap bipolare Instrumente

maxium® "e"-version/ICC and ACC/VIO Erbe units  
 → Aesculap bipolar instruments

maxium® versión "e"/aparatos Erbe ICC e ACC/VIO  
 → instrumentos bipolares Aesculap

maxium® version «e»/appareils Erbe ICC et ACC/VIO  
 → instruments bipolaires Aesculap

maxium® versione "e"/apparecchi Erbe ICC e ACC/VIO  
 → strumenti bipolari Aesculap



80-288-80-04

4 m/13 ft.

Geräte mit 2-Pin-International  
 → Aesculap bipolare Instrumente

units with 2-pin international  
 → Aesculap bipolar instruments

Equipos internacional con 2 alfileres,  
 → instrumentos bipolares Aesculap

Appareils international à 2 broches  
 → instruments bipolaires Aesculap

apparecchi internazionale a 2 pin  
 → strumenti bipolari Aesculap



80-287-89-04

3 m/10 ft.

maxium® „i“-Version, ME MB 3 „i“-Version, ME MB 2 „i“-Version/  
 Valleylab-Geräte → bipolare Instrumente

maxium® "i"-version, ME MB 3 „i“-Version, ME MB 2 „i“-Version/  
 Valleylab units → bipolare Instrumente

maxium® versión "i", ME MB 3 versión "i", ME MB 2 versión "i"/  
 aparatos Valleylab → bipolare Instrumente

maxium® version «i», ME MB 3 version «i», ME MB 2 version «i»/  
 appareils Valleylab → bipolare Instrumente

maxium® versione "i", ME MB 3 versione "i", ME MB 2 versione "i"/  
 apparecchi Valleylab → bipolare Instrumente



80-288-60-04

4 m/13 ft.

maxium® „i“-Version, ME MB 3 „i“-Version, ME MB 2 „i“-Version/  
 Valleylab-Geräte → bipolare Instrumente

maxium® "i"-version, ME MB 3 „i“-Version, ME MB 2 „i“-Version/  
 Valleylab units → bipolare Instrumente

maxium® versión "i", ME MB 3 versión "i", ME MB 2 versión "i"/  
 aparatos Valleylab → bipolare Instrumente

maxium® version «i», ME MB 3 version «i», ME MB 2 version «i»/  
 appareils Valleylab → bipolare Instrumente

maxium® versione "i", ME MB 3 versione "i", ME MB 2 versione "i"/  
 apparecchi Valleylab → bipolare Instrumente

Anschlusskabel für bipolare Resektoskope  
 Connecting cables for bipolar resectoscopes  
 Cables de conexión para resectoscopios bipolares  
 Câbles de raccordement pour résectoscopes bipolaires  
 Cavi di collegamento per resettoscopi bipolari

maxium®



Nur verwendbar mit maxium® (ab HW06), sowie Option „Bipolare Resektion“ Art-Nr. 80-093-00-04

Can be used only with maxium® units (HW06 or higher) and “Bipolar Resection” option, item no. 80-093-00-04

Sólo puede utilizarse con equipos maxium® (a partir del hardware 06 o superior) y la opción “Resección bipolar”, n.º ref. 80-093-00-04

Utilisable uniquement avec maxium® (à partir de la version matérielle 06) et avec l'option « Résection bipolaire » réf. 80-093-00-04

Utilizzabile solo con l'apparecchio maxium® (versione HW06 o superiore) e con l'opzione “Resezione bipolare”, codice art. 80-093-00-04

max. 600 V<sub>p</sub>



80-287-91-04

4 m/13 ft.

- maxium®, „m“-Version  
→ bipolares Resektoskop Olympus
- maxium®, „m“-version  
→ bipolar Olympus resectoscope
- maxium®, versión “m”  
→ resectoscopio bipolar Olympus
- maxium®, version «m»  
→ résectoscope bipolaire Olympus
- maxium®, versione “m”  
→ resettoscopio bipolare Olympus

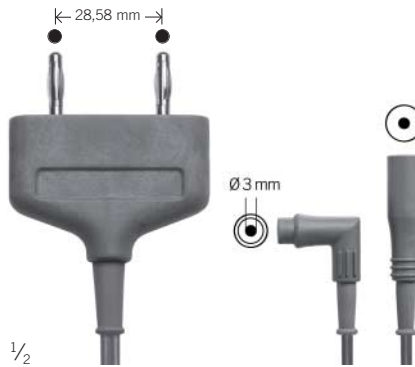

80-287-94-04

4 m/13 ft.

- maxium®, „m/i/e“-Versionen  
→ bipolares Resektoskop Olympus
- maxium®, „m/i/e“-versions  
→ bipolar Olympus resectoscope
- maxium®, versiones “m/i/e”  
→ resectoscopio bipolar Olympus
- maxium®, versions «m/i/e»  
→ résectoscope bipolaire Olympus
- maxium®, versioni “m/i/e”  
→ resettoscopio bipolare Olympus



80-287-93-04

4 m/13 ft.

- maxium®, „m“-Version  
→ bipolares Resektoskop Richard Wolf
- maxium®, „m“-version  
→ bipolar Richard Wolf resectoscope
- maxium®, versión “m”  
→ resectoscopio bipolar Richard Wolf
- maxium®, version «m»  
→ résectoscope bipolaire Richard Wolf
- maxium®, versione “m”  
→ resettoscopio bipolare Richard Wolf



80-287-96-04

4 m/13 ft.

- maxium®, „m/i/e“-Versionen  
→ bipolares Resektoskop Karl Storz
- maxium®, „m/i/e“-versions  
→ bipolar Karl Storz resectoscope
- maxium®, versiones “m/i/e”  
→ resectoscopio bipolar Karl Storz
- maxium®, versions «m/i/e»  
→ résectoscope bipolaire Karl Storz
- maxium®, versioni “m/i/e”  
→ resettoscopio bipolare Karl Storz



80-287-95-04

4 m/13 ft.

- maxium®, „m/i/e“-Versionen  
→ bipolares Resektoskop Richard Wolf
- maxium®, „m/i/e“-versions  
→ bipolar Richard Wolf resectoscope
- maxium®, versiones “m/i/e”  
→ resectoscopio bipolar Richard Wolf
- maxium®, versions «m/i/e»  
→ résectoscope bipolaire Richard Wolf
- maxium®, versioni “m/i/e”  
→ resettoscopio bipolare Richard Wolf

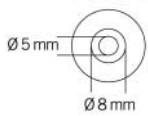
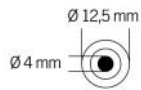

94-810-28-04 **max. 700 V<sub>p</sub>**  
Monopolarer Adapter für KLS-Martin-Geräte  
und Erbe-Zubehör

Monopolar adapter for KLS Martin units  
and Erbe accessories

Adaptador monopolar para aparatos  
KLS Martin y accesorios Erbe

Adaptateur monopolaire pour appareils  
KLS Martin et accessoires Erbe

Adattatore monopolare per apparecchi  
KLS Martin ed accessori Erbe

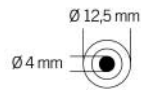

80-795-05-04 **max. 700 V<sub>p</sub>**  
Monopolarer Adapter für KLS-Martin-Geräte  
und Internationales Zubehör (3-Pin)

Monopolar adapter for KLS Martin units  
and international accessories (3-pin)

Adaptador monopolar para aparatos  
KLS Martin y accesorios internacional (3 pin)

Adaptateur monopolaire pour appareils  
KLS Martin et accessoires international (3 pin)

Adattatore monopolare per apparecchi  
KLS Martin ed accessori internazionale (3- pin)

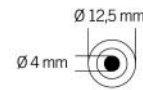

80-251-00-04 **max. 700 V<sub>p</sub>**  
Monopolarer Adapter für KLS-Martin-  
Geräte und Bovie-Zubehör

Monopolar adapter for KLS Martin units  
and Bovie accessories

Adaptador monopolar para aparatos  
KLS Martin y accesorios Bovie

Adaptateur monopolaire pour appareils  
KLS Martin et accessoires Bovie

Adattatore monopolare per apparecchi  
KLS Martin ed accessori Bovie

## NON-CE



80-795-04-04 **max. 4000 V<sub>p</sub>**  
Monopolarer Adapter mit Bovie-Stecker  
Für Anschlussstecker 2-4 mm (1-polig)  
Monopolar adapter with Bovie connector  
For 2-4 mm cable connectors (1-pole)  
Adaptador monopolar con clavija Bovie  
Para clavijas de conexión de 2-4 mm (1 polo)  
Adaptateur monopolaire avec connecteur Bovie  
Pour connecteur 2-4 mm (1 pôle)  
Adattatore monopolare con connettore Bovie  
Per connettore 2-4 mm (1 polo)



80-795-03-04 **max. 4000 V<sub>p</sub>**  
Monopolares Adapterkabel für Erbe-Geräte (ICC, ACC, VIO)  
und KLS-Martin-Zubehör  
Monopolar adapter cable for Erbe units (ICC, ACC, VIO)  
and KLS Martin accessories  
Cable adaptador monopolar para equipos Erbe (ICC, ACC, VIO)  
y accesorios de KLS Martin  
Câble d'adaptateur monopolaire pour appareils Erbe (ICC, ACC, VIO)  
et accessoires KLS Martin  
Cavo adattatore monopolare per apparecchi Erbe (ICC, ACC, VIO)  
e accessori KLS Martin



80-795-02-04 **max. 700 V<sub>p</sub>**

Bipolarer Adapter für KLS-Martin-Geräte und Erbe-Zubehör

Bipolar adapter for KLS Martin units and Erbe accessories

Adaptador bipolar para aparatos KLS Martin y accesorios Erbe

Adaptateur bipolaire pour appareils KLS Martin et accessoires Erbe

Adattatore bipolare per apparecchi KLS Martin ed accessori Erbe

## NON-CE



80-250-00-04 **max. 4000 V<sub>p</sub>**

Adapter von Koax-Buchse auf 3-Pin-System

Adapter, coaxial socket/3-pin system

Adaptador de enchufe coaxial para clavijero a sistema de 3 patillas

Adaptateur pour système à 3 fiches sur prise coax

Adattatore per collegamento manipoli con attacco a 3-spine



80-796-02-04 **max. 700 V<sub>p</sub>**

Bipolares Adapterkabel für KLS-Martin-Geräte  
→ Erbe-Zubehör

Bipolar adapter cable for KLS Martin units  
→ Erbe accessories

Cable adaptador bipolar para aparatos KLS Martin  
→ Accesorios Erbe

Câble adaptateur bipolaire pour appareils KLS Martin  
→ Accessoires Erbe

Cavo adattatore bipolare per apparecchi KLS Martin  
→ Accessori Erbe



80-793-02-04 **max. 700 V<sub>p</sub>**

25 cm/10"

Bipolares Adapterkabel für KLS-Martin-Geräte  
→ Codman-/Valleylab-Instrumente

Bipolar adapter cable for KLS Martin units  
→ Codman/Valleylab instruments

Cable adaptador bipolar para aparatos KLS Martin  
→ Instrumentos Codman/Valleylab

Câble adaptateur bipolaire pour appareils KLS Martin  
→ Instruments Codman/Valleylab

Cavo adattatore bipolare per apparecchi KLS Martin  
→ Strumenti Codman/Valleylab



1/2

**80-797-02-04 max. 700 V<sub>p</sub>**

Bipolares Adapterkabel für Erbe-Geräte (ICC, ACC, VIO) und KLS-Martin-Zubehör

Bipolar adapter cable for Erbe units (ICC, ACC, VIO) and KLS Martin accessories

Cable adaptador bipolar para equipos Erbe (ICC, ACC, VIO) y accesorios de KLS Martin

Câble d'adaptateur bipolaire pour appareils Erbe (ICC, ACC, VIO) et accessoires KLS Martin

Cavo adattatore bipolare per apparecchi Erbe (ICC, ACC, VIO) e accessori KLS Martin



1/2

**80-794-02-04 max. 700 V<sub>p</sub>**

Bipolarer Adapter für KLS-Martin-Geräte („i“-Version) und Valleylab-Zubehör

Bipolar adapter for KLS Martin units (“i“-version) and Valleylab accessories

Adaptador bipolar para aparatos KLS Martin (versión “i”) y accesorios Valleylab

Adaptateur bipolaire pour appareils KLS Martin (version «i») et accessoires Valleylab

Adattatore bipolare per apparecchi KLS Martin (versione “i”) ed accessori Valleylab



1/2

**80-796-03-04 max. 700 V<sub>p</sub>**

Adapter für Neutralelektrode mit I-Stecker 6,3 mm-NE-Buchse

Adapter for neutral electrode with I-plug, for 6,3-mm NE socket

Adaptador para placa neutra con clavija I, para hembra de PN de 6,3 mm

Adaptateur pour électrode neutre avec connecteur I, pour fiche EN 6,3 mm

Adattatore per elettrodo neutro con spina I, per presa EN da 6,3 mm



**08-003-00-50 max. 700 V<sub>p</sub>**

Bipolarer Port-Expander für maxium® „m“-Version (bis HW05)

Bipolar port expander for maxium® “m“-version (up to HW05)

Extensor de puerto bipolar para maxium® versión “m” (hasta HW05)

Expansor de port bipolaire pour maxium® version «m» (jusqu'à HW05)

Espansore di porta bipolare per maxium® versione “e” (fino a HW05)

Bipolarer Port-Expander für maxium®  
 Bipolar port expander for maxium®  
 Expansor de puerto bipolar para maxium®  
 Expenseur de port bipolaire pour maxium®  
 Espansore di porta bipolare per maxium®

Ab Hardware 06 und Software V 3.394  
 From hardware 06 and software V3.394  
 A partir del hardware 06 y del software V3.394  
 À partir de la version matérielle 06 et de la version logicielle V3.394  
 A partire dalla versione hardware 06 e dalla versione software V3.394

maxium®

max. 2500 V<sub>p</sub>

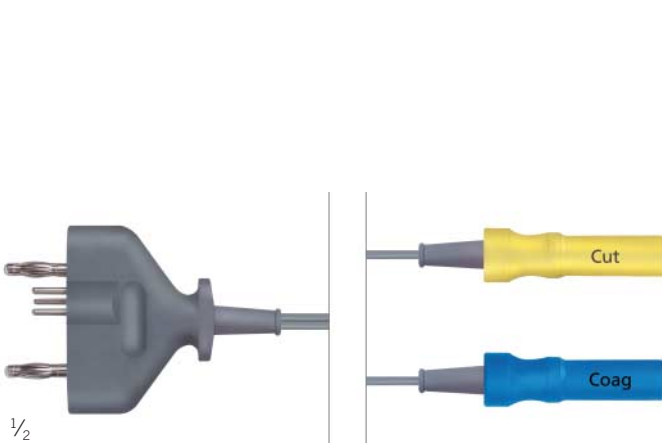

80-790-00-04

Bipolarer Port-Expander für maxium®, Version KLS Martin  
 (ab Hardware 06 und Software V3.394), zum Anschluss  
 von zwei Instrumentenkabeln mit 8-mm-Koaxstecker

Bipolar port expander for maxium®, KLS Martin version  
 (hardware 06 and software V3.394, or higher), for connecting  
 two bipolar instrument cables with 8-mm coaxial plugs

Expansor de puerto bipolar para maxium®, versión “KLS Martin”  
 (a partir del hardware 06 y del software V3.394, o superior),  
 para la conexión de dos cables de instrumento con clavija  
 coaxial de 8 mm

Expenseur de port bipolaire pour maxium® version «KLS Martin»  
 (à partir de la version matérielle 06 et de la version logicielle  
 V3.394), pour le raccordement de deux câbles d’instruments  
 bipolaires avec fiches coaxiales de 8 mm

Espansore di porta bipolare per maxium® versione “KLS Martin”  
 (a partire dalla versione hardware 06 e dalla versione  
 software V3.394), per il collegamento di due cavi per strumenti  
 bipolari con spine coassiali da 8 mm

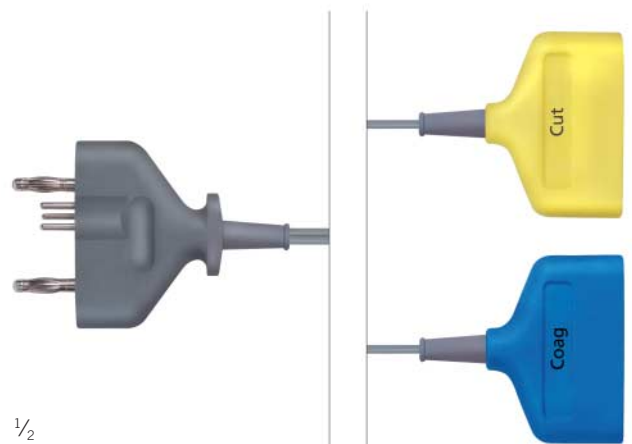

80-790-01-04

Bipolarer Port-Expander für maxium®, Version „international”  
 (ab Hardware 06 und Software V3.394), zum Anschluss von  
 zwei bipolaren Instrumentenkabeln mit 4-mm-Steckern

Bipolar port expander for maxium®, international version  
 (hardware 06 and software V3.394, or higher), for connecting  
 two bipolar instrument cables with 4-mm plugs

Expansor de puerto bipolar para maxium®, versión “internacional”  
 (a partir del hardware 06 y del software V3.394, o superior),  
 para la conexión de dos cables de instrumento bipolares con  
 clavijas de 4 mm

Expenseur de port bipolaire pour maxium®, version «international»  
 (à partir de la version matérielle 06 et de la version logicielle  
 V3.394), pour le raccordement de deux câbles d’instruments  
 bipolaires avec fiches de 4 mm

Espansore di porta bipolare per maxium®, versione “internazionale”  
 (a partire dalla versione hardware 06 e dalla versione software V3.394),  
 per il collegamento di due cavi per strumenti bipolari con spine  
 da 4 mm



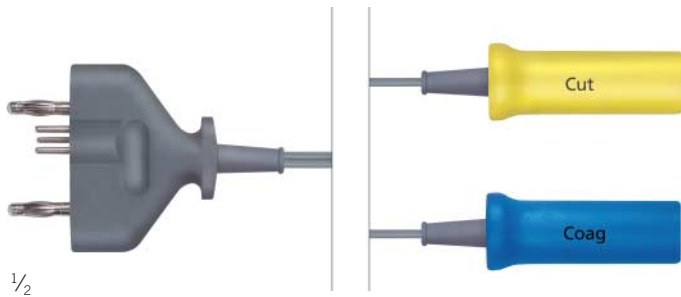

80-790-02-04

Bipolarer Port-Expander für maxium®, Version Erbe (ab Hardware 06 und Software V3.394), zum Anschluss von zwei bipolaren Instrumentenkabeln mit 12-mm-Koaxstecker

Bipolar port expander for maxium®, Erbe version (hardware 06 and software V3.394, or higher), for connecting two bipolar instrument cables with 12-mm coaxial plugs

Expansor de puerto bipolar para maxium®, versión "Erbe" (a partir del hardware 06 y del software V3.394, o superior), para la conexión de dos cables de instrumento bipolares con clavijas coaxiales de 12 mm

Expanseur de port bipolaire pour maxium®, version «Erbe» (à partir de la version matérielle 06 et de la version logicielle V3.394), pour le raccordement de deux câbles d'instruments bipolaires avec fiches coaxiales de 12 mm

Espansore di porta bipolare per maxium®, versione "Erbe" (a partire dalla versione hardware 06 e dalla versione software V3.394), per il collegamento di due cavi per strumenti bipolari con spine coassiali da 12 mm



80-800-00-04

Kabelmarkierung autoklavierbar, Set bestehend aus drei Farben (gelb, grün, rot)





















Cable markers, autoclavable, set including three colors (yellow, green, red)

Marca de cable, autoclavable, juego compuesto de tres colores diferentes (amarillo, verde, rojo)

Marquage pour câbles, autoclavable, set comprenant trois couleurs (jaune, vert, rouge)

Contrassegno per cavo, autoclavabile, set costituito da tre colori diversi (giallo, verde, rosso)











Übersicht monopolare Anschlusskabel  
 Reference table monopolar connection cables  
 Sinopsis de asignación cables de conexión monopolares  
 Classification sommaire câbles de raccordement monopolaires  
 Schema delle corrispondenze cavi di connessione monopolari

<p>Geräte Units Equipos Appareils Apparecchi</p>	<p>Instrumente Instruments Instrumentos Instruments Strumenti</p>	<p>Olympus</p>			<p>einpolig monopole unipolar monopolaire monopolare</p>
<p>KLS Martin Berchtold Aesculap</p>  		  <p>1/3</p>	 	 	 
<p>maxium® „e“ Erbe ICC Erbe ACC Erbe VIO</p>  		<p>80-289-40-04 4 m/13 ft. <i>max. 4000 V<sub>p</sub></i></p>	<p>83-120-50-04 5 m/16 ft. <i>max. 4000 V<sub>p</sub></i></p>		
<p>Erbotom</p>  			<p>83-122-50-04 5 m/16 ft. <i>max. 4000 V<sub>p</sub></i></p>		
<p>3-Pin maxium® ME MB 3 „i“ ME MB 2 „i“</p> 		<p>80-289-41-04 4 m/13 ft. <i>max. 4000 V<sub>p</sub></i></p>	<p>83-120-51-04 5 m/16 ft. <i>max. 4000 V<sub>p</sub></i></p>	<p>80-290-40-04 4 m/13 ft. <i>max. 4000 V<sub>p</sub></i></p>	
<p>maxium® ME MB 3 „i“ ME MB 2 „i“ Valleylab</p>  			<p>83-124-50-04 5 m/16 ft. <i>max. 4000 V<sub>p</sub></i></p>		
<p>einpolig monopole unipolar monopolaire monopolare <b>NON-CE</b></p>  					<p>80-280-30-04 3 m/10 ft. <i>max. 4000 V<sub>p</sub></i></p>
<p>KLS Martin Isolit-Pinzetten Isolit forceps Pinzas Isolit Pinces Isolit Pinze Isolit</p>  					









KLS Martin Isolit-Pinzetten Isolit forceps Pinzas Isolit Pincze Isolit Pinze Isolit	Olympus Monopolares Resektoskop Monopolar resectoscope Resectoscopio monopolar Résectoscope monopolaire Resettoscopio monpolare	Richard Wolf Monopolares Resektoskop Monopolar resectoscope Resectoscopio monopolar Résectoscope monopolaire Resettoscopio monpolare	Karl Storz Monopolares Resektoskop Monopolar resectoscope Resectoscopio monopolar Résectoscope monopolaire Resettoscopio monpolare
			
80-285-55-04 4 m/13 ft. <i>max. 4000 V<sub>p</sub></i>	80-286-94-04 4 m/13 ft. <i>max. 4000 V<sub>p</sub></i>	80-286-95-04 4 m/13 ft. <i>max. 4000 V<sub>p</sub></i>	80-286-96-04 4 m/13 ft. <i>max. 4000 V<sub>p</sub></i>
83-124-52-04 4 m/13 ft. <i>max. 4000 V<sub>p</sub></i>			
80-285-40-04 4 m/13 ft. <i>max. 4000 V<sub>p</sub></i>  80-285-50-04 5 m/16 ft. <i>max. 4000 V<sub>p</sub></i>			

Übersicht bipolare Anschlusskabel  
 Reference table bipolar connection cables  
 Sinopsis de asignación cables de conexión bipolares  
 Classification sommaire câbles de raccordement bipolaires  
 Schema delle corrispondenze cavi di connessione bipolari

<p>Geräte Units Equipos Appareils Apparecchi</p>	<p>Instrumente Instruments Instrumentos Instruments Strumenti</p>	<p>Europäischer Flachstecker European flat plug Enchufe plano para Europa Fiche plate européenne Spina piatta Europea</p>	<p>Europäischer Flachstecker European flat plug Enchufe plano para Europa Fiche plate européenne Spina piatta Europea</p>	<p>Karl Storz</p>
<p>KLS Martin Berchtold Aesculap</p>  	<p>80-287-33-04 3 m/10 ft. <b>max. 600 V<sub>p</sub></b></p> <p>80-287-53-04 5 m/16 ft. <b>max. 600 V<sub>p</sub></b></p>	<p>80-291-40-04 4 m/13 ft. <b>max. 850 V<sub>p</sub></b></p>	<p>80-287-60-04 4 m/13 ft. <b>max. 600 V<sub>p</sub></b></p>	<p>80-287-42-04 4 m/13 ft. <b>max. 600 V<sub>p</sub></b></p>
<p>maxium® „e“ Erbe ICC Erbe ACC Erbe VIO</p>  	<p>80-286-30-04 3 m/10 ft. <b>max. 600 V<sub>p</sub></b></p> <p>80-286-50-04 5 m/16 ft. <b>max. 600 V<sub>p</sub></b></p>	<p>80-286-40-04 4 m/13 ft. <b>max. 850 V<sub>p</sub></b></p>	<p>80-286-60-04 4 m/13 ft. <b>max. 600 V<sub>p</sub></b></p>	
<p>maxium® „i“ maxium® „e“ ME MB 2 „i“ ME MB 3 „i“ Valleylab</p>  	<p>80-287-89-04 3 m/10 ft. <b>max. 600 V<sub>p</sub></b></p> <p>80-287-90-04 5 m/16 ft. <b>max. 600 V<sub>p</sub></b></p>	<p>80-293-40-04 4 m/13 ft. <b>max. 850 V<sub>p</sub></b></p>	<p>80-288-60-04 4 m/13 ft. <b>max. 600 V<sub>p</sub></b></p>	<p>80-287-44-04 4 m/13 ft. <b>max. 600 V<sub>p</sub></b></p>
<p>Codman Valleylab</p>  	<p>80-287-72-04 5 m/16 ft. <b>max. 600 V<sub>p</sub></b></p>			
<p>Codman Valleylab <b>NON-CE</b></p>   	<p>80-287-70-04 5 m/16 ft. <b>max. 600 V<sub>p</sub></b></p>			



<p>Karl Storz                      Endoskope                      Endoscopes                      Endoscopios                      Endoscopes                      Endoscopi</p> 	<p>Aesculap                      Flachstecker/tab connector                      Tab connector                      Conector plano/tab connector                      Connecteur plat/tab connector                      Connettore piatto/tab connecto</p> 	<p>Valleylab                      Pinzetten                      Forceps                      Pinzas                      Pincas                      Pinze</p> 	<p>Ethicon (PowerStar)                      Scheren                      Scissors                      Tijeras                      Ciseaux                      Forbici</p> 	<p>Olympus                      Bipolares Resektoskop                      Bipolar resectoscope                      Resectoscopio bipolar                      Résectoscope bipolaire                      Resetoscopio bipolare</p> 	<p>Karl Storz                      Bipolares Resektoskop                      Bipolar resectoscope                      Resectoscopio bipolar                      Résectoscope bipolaire                      Resetoscopio bipolare</p> 	<p>Richard Wolf                      Bipolares Resektoskop                      Bipolar resectoscope                      Resectoscopio bipolar                      Résectoscope bipolaire                      Resetoscopio bipolare</p> 
<p>80-285-51-04                      4 m/13 ft.                      max. 600 V<sub>p</sub></p>	<p>80-287-80-04                      4 m/13 ft.                      max. 600 V<sub>p</sub></p>	<p>80-288-53-04                      4 m/13 ft.                      max. 600 V<sub>p</sub></p>	<p>80-288-55-04                      5 m/16 ft.                      max. 600 V<sub>p</sub></p>	<p>80-287-91-04                      4 m/13 ft.                      max. 600 V<sub>p</sub></p>		<p>80-287-93-04                      4 m/13 ft.                      max. 600 V<sub>p</sub></p>
	<p>80-286-80-04                      4 m/13 ft.                      max. 600 V<sub>p</sub></p>					
	<p>80-288-80-04                      4 m/13 ft.                      max. 600 V<sub>p</sub></p>		<p>80-288-57-04                      5 m/16 ft.                      max. 600 V<sub>p</sub></p>	<p>80-287-94-04                      4 m/13 ft.                      max. 600 V<sub>p</sub></p>	<p>80-287-96-04                      4 m/13 ft.                      max. 600 V<sub>p</sub></p>	<p>80-287-95-04                      4 m/13 ft.                      max. 600 V<sub>p</sub></p>





KLS-MARTIN-ARGON-BEAMER-SYSTEM (MABS)  
KLS MARTIN ARGON BEAMER SYSTEM (MABS)  
SISTEMA KLS MARTIN ARGON BEAMER (MABS)  
SYSTEME KLS MARTIN ARGON BEAMER (MABS)  
SISTEMA KLS MARTIN ARGON BEAMER (MABS)

109-123



MABS-Handgriff für starre Applikatoren  
MABS handle for rigid applicators  
Mango MABS para aplicadores rígidos  
Manche MABS pour applicateurs rigides  
Manipolo MABS per applicatori rigidi

*MABS – Das KLS-Martin-Argon-Beamer-System*  
*MABS – The KLS Martin Argon Beamer System*  
*MABS – El sistema KLS Martin Argon Beamer*  
*MABS – Le système KLS Martin Argon Beamer*  
*MABS – Il sistema KLS Martin Argon Beamer*



80-181-02-04

MABS-Handgriff für starre Applikatoren  
Zwei Tasten für Koagulation und Schneiden  
Anschlusskabel 4,5 m/15 ft. für HF-Strom und Argon-Gas  
Autoklavierbar bei 134 °C

MABS handle for rigid applicators  
Two pushbuttons for coagulating and cutting  
Connection cable 4.5 m/15 ft. in length, for HF current and argon gas  
Autoclavable at 134°C

Mango MABS para aplicadores rígidos  
Dos teclas para la coagulación y el corte  
Cable de conexión de 4,5 m/15 pies para la corriente AF y el gas argón  
Autoclavable a 134 °C

Manche MABS pour applicateurs rigides  
Deux touches pour coagulation et coupe  
Câble de raccordement 4,5 m/15 ft. pour courant HF et gaz d'argon  
Peut passer à l'autoclave à 134 °C

Manipolo MABS per applicatori rigidi  
Due pulsanti per taglio e coagulazione  
Cavo di collegamento di 4,5 m/15 ft. per corrente AF e gas argon  
Autoclavabile a 134 °C



80-181-90-04

MABS-Sterilfilter, VE = 50 Stück  
MABS sterile filter, SU = 50/pack  
Filtro estéril MABS, UV = 50 piezas  
Filtre stérile MABS, UC = 50 unités  
Filtro sterile MABS, UV = 50 pezzi





Die MABS-Elektroden haben folgende gemeinsame Eigenschaften:

- Isolierter, starrer Schaft mit einem Durchmesser von 5 mm
- Distale Keramikdüse
- Autoklavierbar bei 134 °C
- Hochtemperaturfeste Zündspitze

Les électrodes MABS présentent les performances communes suivantes:

- Tige rigide, isolée, d'un diamètre de 5 mm
- Buse distale en céramique
- Pouvant passer en autoclave à 134 °C
- Pointe de contact résistant aux températures élevées

All MABS electrodes share the following features:

- Insulated, rigid shaft with a diameter of 5 mm
- Distal ceramic nozzle
- Autoclavable at 134°C
- High-temperature-resistant ignition tip

Gli elettrodi MABS possiedono le seguenti caratteristiche comuni:

- Asta isolato e rigido con un diametro di 5 mm
- Ugello distale di ceramica
- Autoclavabile a 134 °C
- Punta resistente alle elevate temperature

Los electrodos del MABS cuentan con las siguientes características funcionales:

- Varilla aislada y rígida con un diámetro de 5 mm
- Inyector de cerámica distal
- Autoclavable a 134 °C
- Punta de ignición resistente a las altas temperaturas



1/2

#### 80-181-05-04

Fixierkappe, passend für alle starren Elektroden  
 Fixing cap, suitable for all rigid electrodes  
 Capuchón de fijación, adecuado para todos los electrodos rígidos  
 Capuchon de fixation, pour toutes les électrodes rigides  
 Cappuccio di fissaggio, per tutti gli elettrodi rigidi



1/2

#### 80-181-10-04

MABS-Beam-Elektrode für die offene Chirurgie  
 Hochtemperaturfeste Zündspitze  
 MABS beam electrode for open surgery  
 High-temperature-resistant ignition tip  
 Electrodo MABS Beam para la cirugía abierta  
 Punta de ignición resistente a las altas temperaturas  
 Electrode MABS Beam pour la chirurgie ouverte  
 Pointe de contact résistant aux températures élevées  
 Elettrodo MABS Beam per la chirurgia aperta  
 Punta resistente alle elevate temperature



1/2

#### 80-181-11-04

MABS-Beam-Elektrode für die offene Chirurgie  
 Hochtemperaturfeste Zündspitze  
 MABS beam electrode for open surgery  
 High-temperature-resistant ignition tip  
 Electrodo MABS Beam para la cirugía abierta  
 Punta de ignición resistente a las altas temperaturas  
 Electrode MABS Beam pour la chirurgie ouverte  
 Pointe de contact résistant aux températures élevées  
 Elettrodo MABS Beam per la chirurgia aperta  
 Punta resistente alle elevate temperature



80-181-12-04

MABS-Beam-Elektrode für die Laparoskopie und Pelviskopie, hochtemperaturfeste Zündspitze, inkl. Fixierkappe

MABS beam electrode for laparoscopy and pelviscopy, high-temperature-resistant ignition tip, incl. fixing cap

Electrodo MABS beam para la laparoscopia y pelviscopia, punta de ignición resistente a las altas temperaturas, incl. capuchón de fijación

Electrode MABS beam pour la laparoscopie et la pelviscopia, pointe de contact résistante aux températures élevées, capuchon de fixation compris

Elettrodo MABS beam per laparoscopia e pelviscopia, punta resistente alle elevate temperature, compreso cappuccio di fissaggio

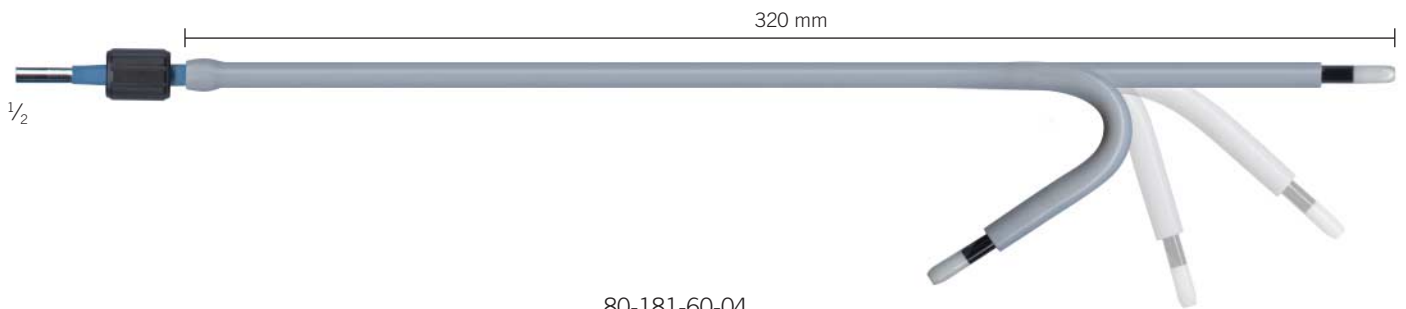

80-181-60-04

MABS-Beam-Elektrode, 320 mm, biegsam

MABS beam electrode, 320 mm, flexible

Electrodo MABS beam, 320 mm, flexible

Electrode MABS beam, 320 mm, flexible

Elettrodo MABS beam, 320 mm, flessibile



80-181-62-04

MABS-Beam-Elektrode, 115 mm, biegsam

MABS beam electrode, 115 mm, flexible

Electrodo MABS beam, 115 mm, flexible

Electrode MABS beam, 115 mm, flexible

Elettrodo MABS beam, 115 mm, flessibile



80-181-13-04

MABS-Lanzetten-Elektrode für die offene Chirurgie  
 MABS lancet electrode for open surgery  
 Electrodo de lanceta MABS para la cirugía abierta  
 Electrode couteaux MABS pour la chirurgie ouverte  
 Elettrodo a lancetta MABS per la chirurgia aperta



80-181-14-04

MABS-Lanzetten-Elektrode für die offene Chirurgie  
 MABS lancet electrode for open surgery  
 Electrodo de lanceta MABS para la cirugía abierta  
 Electrode couteaux MABS pour la chirurgie ouverte  
 Elettrodo a lancetta MABS per la chirurgia aperta

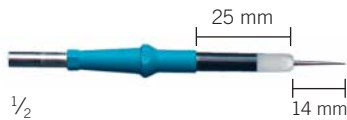

80-181-15-04

MABS-Nadel-Elektrode für die offene Chirurgie  
 MABS needle electrode for open surgery  
 Electrodo de aguja MABS para la cirugía abierta  
 Electrode aiguille MABS pour la chirurgie ouverte  
 Elettrodo ad ago MABS per la chirurgia aperta

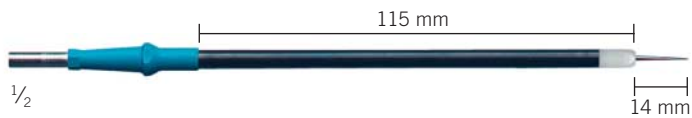

80-181-16-04

MABS-Nadel-Elektrode für die offene Chirurgie  
 MABS needle electrode for open surgery  
 Electrodo de aguja MABS para la cirugía abierta  
 Electrode aiguille MABS pour la chirurgie ouverte  
 Elettrodo ad ago MABS per la chirurgia aperta



80-181-07-04

MABS-Nadel-Elektrode für die offene Chirurgie, verschiebbar  
 MABS needle electrode for open surgery, adjustable  
 Electrodo de aguja MABS para la cirugía abierta, regulable  
 Electrode aiguille MABS pour la chirurgie ouverte, réglable  
 Elettrodo ad ago MABS per la chirurgia aperta, regolabile

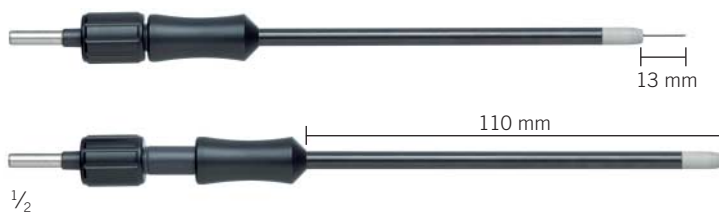

80-181-08-04

MABS-Nadel-Elektrode für die offene Chirurgie, verschiebbar  
 MABS needle electrode for open surgery, adjustable  
 Electrodo de aguja MABS para la cirugía abierta, regulable  
 Electrode aiguille MABS pour la chirurgie ouverte, réglable  
 Elettrodo ad ago MABS per la chirurgia aperta, regolabile

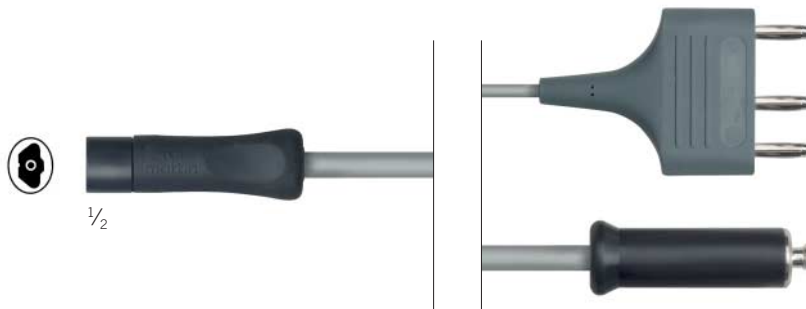

#### 80-181-30-04

MABS-Anschlussleitung für flexible Sonden (disposable und wiederverwendbar)  
 Anschlusskabel 2,5 m, für HF-Strom und Argongas  
 HF- und Gas-Aktivierung über Fußschalter  
 Autoklavierbar bei 134 °C

MABS connection cable for flexible probes (disposable and reusable)  
 Connection cable, 2.5 m, for HF current and argon gas  
 HF-current and gas-flow activation via foot switch  
 Autoclavable at 134°C

Línea de conexión MABS para sondas flexibles (desechables y reutilizables)  
 Cable de conexión de 2,5 m, para corriente AF y gas argón  
 Activación AF y del gas por medio del interruptor de pedal  
 Autoclavable a 134 °C

Conduite raccord MABS pour sondes flexibles (à usage unique et réutilisables)  
 Câble de raccordement, 2,5 m, pour courant HF et gaz d'argon  
 Activation HF et gaz par l'intermédiaire d'un interrupteur à pied  
 Peut passer à l'autoclave à 134 °C

Cavo di collegamento MABS per sonde flessibili (monouso e riutilizzabili)  
 Cavo di collegamento, 2,5 m, per corrente AF e gas argon  
 Attivazione AF e gas mediante interruttore a pedale  
 Autoclavabile a 134 °C



#### 80-181-90-04

MABS-Sterilfilter, VE = 50 Stück  
 MABS sterile filter, SU = 50/pack  
 Filtro estéril MABS, UV = 50 piezas  
 Filtre stérile MABS, UC = 50 unités  
 Filtro sterile MABS, UV = 50 pezzi



#### 80-181-31-04

MABS-Spüladapter für wiederverwendbare Argon-Sonden, VE = 5 Stück  
 MABS rinsing adapter for reusable argon probes, SU = 5/pack  
 Adaptador de enjuague MABS para sondas argon reutilizables, UV = 5 piezas  
 Adaptateur de rinçage MABS pour sondes argon réutilisables, UC = 5 unités  
 Adattatore di lavaggio MABS per sonde riutilizzabili, UV = 5 pezzi



**MABS flexible Sonden haben folgende gemeinsame Eigenschaften:**

- Distale Keramikdüse
- Skaliertes Sondenende
- Autoklavierbar bei 134 °C (nur wiederverwendbare Sonden)
- Um 50 % reduzierter Gasverbrauch (im Vergleich zu bisherigen Sonden)

**Les sondes MABS flexibles présentent les caractéristiques communes suivantes:**

- Buse distale en céramique
- Extrémité de la sonde graduée
- Peut passer à l'autoclave à 134 °C (seules les sondes sont réutilisables)
- Consommation de gaz réduite de 50 % (par rapport aux anciennes sondes)

**All MABS flexible probes have the following features in common:**

- Distal ceramic nozzle
- Scaled probe tip
- Autoclavable at 134°C (only reusable probes)
- Reduced gas consumption (50% lower than previous probes)

**Le sonde flessibili MABS hanno le seguenti caratteristiche comuni:**

- Ugello distale di ceramica
- Estremità della sonda graduata
- Autoclavabile a 134 °C (solo le sonde riutilizzabili)
- Consumo di gas ridotto del 50 % (nei confronti delle sonde avute sinora)

**Las sondas flexibles MABS tienen las siguientes características técnicas comunes:**

- Inyector de cerámica distal
- Terminación de la sonda escalada
- Autoclavable a 134 °C (sólo las sondas reutilizables)
- Consumo de gas reducido en un 50 % (en comparación con las sondas anteriores)

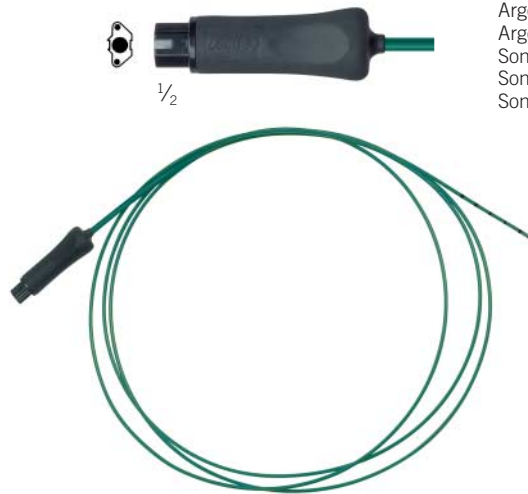



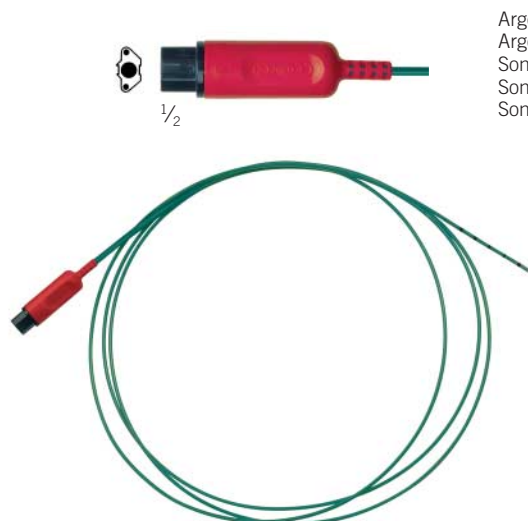



Argon-Sonde (wiederverwendbar)  
 Argon probe (reusable)  
 Sonda Argon (reutilizable)  
 Sonde Argon (réutilisable)  
 Sonda Argon (riutilizzabile)



Argon-Sonde (Einweg)  
 Argon probe (disposable)  
 Sonda Argon (desechable)  
 Sonde Argon (à usage unique)  
 Sonda Argon (monouso)

Flexible MABS-Sonden  
MABS flexible probes  
Sondas flexibles MABS  
Sondes MABS flexibles  
Sonde flessibili MABS

80-181-23-04					
MABS-GIT-Sonde	Ø 2,3 mm, Länge 2,3 m	wiederverwendbar	(VE 1 Stk.)		
MABS GIT Probe	Ø 2,3 mm, Length 2,3 m	reusable	(1/pack)		
Sonda MABS GIT	Ø 2,3 mm, Largo 2,3 m	reutilizable	(1/unidad)		
Sonde MABS GIT	Ø 2,3 mm, Longueur 2,3 m	réutilisable	(1/unité)		
Sonda MABS GIT	Ø 2,3 mm, Lunghezza 2,3 m	riutilizzabile	(1/unità)		
80-181-24-04					
MABS-GIT-Sonde	Ø 3,2 mm, Länge 2,3 m	wiederverwendbar	(VE 1 Stk.)		
MABS GIT Probe	Ø 3,2 mm, Length 2,3 m	reusable	(1/pack)		
Sonda MABS GIT	Ø 3,2 mm, Largo 2,3 m	reutilizable	(1/unidad)		
Sonde MABS GIT	Ø 3,2 mm, Longueur 2,3 m	réutilisable	(1/unité)		
Sonda MABS GIT	Ø 3,2 mm, Lunghezza 2,3 m	riutilizzabile	(1/unità)		
80-181-25-04					
MABS-TBS-Sonde	Ø 1,8 mm, Länge 1,6 m	Einweg	(VE 10 Stk.)		
MABS TBS Probe	Ø 1,8 mm, Length 1,6 m	disposable	(10/pack)		
Sonda MABS TBS	Ø 1,8 mm, Largo 1,6 m	desechable	(10/unidad)		
Sonde MABS TBS	Ø 1,8 mm, Longueur 1,6 m	à usage unique	(10/unité)		
Sonda MABS TBS	Ø 1,8 mm, Lunghezza 1,6 m	monouso	(10/unità)		
80-181-26-04					 Double balloon enteroscopy
MABS-GIT-Sonde	Ø 1,8 mm, Länge 3,2 m	Einweg	(VE 10 Stk.)		
MABS GIT Probe	Ø 1,8 mm, Length 3,2 m	disposable	(10/pack)		
Sonda MABS GIT	Ø 1,8 mm, Largo 3,2 m	desechable	(10/unidad)		
Sonde MABS GIT	Ø 1,8 mm, Longueur 3,2 m	usage unique	(10/unité)		
Sonda MABS GIT	Ø 1,8 mm, Lunghezza 3,2 m	monouso	(10/unità)		
80-181-27-04					
MABS-GIT-Sonde	Ø 2,3 mm, Länge 2,3 m	Einweg	(VE 10 Stk.)		
MABS GIT Probe	Ø 2,3 mm, Length 2,3 m	disposable	(10/pack)		
Sonda MABS GIT	Ø 2,3 mm, Largo 2,3 m	desechable	(10/unidad)		
Sonde MABS GIT	Ø 2,3 mm, Longueur 2,3 m	usage unique	(10/unité)		
Sonda MABS GIT	Ø 2,3 mm, Lunghezza 2,3 m	monouso	(10/unità)		
80-181-28-04					
MABS-GIT-Sonde	Ø 3,2 mm, Länge 2,3 m	Einweg	(VE 10 Stk.)		
MABS GIT Probe	Ø 3,2 mm, Length 2,3 m	disposable	(10/pack)		
Sonda MABS GIT	Ø 3,2 mm, Largo 2,3 m	desechable	(10/unidad)		
Sonde MABS GIT	Ø 3,2 mm, Longueur 2,3 m	usage unique	(10/unité)		
Sonda MABS GIT	Ø 3,2 mm, Lunghezza 2,3 m	monouso	(10/unità)		
80-181-29-04					 Double balloon enteroscopy
MABS-GIT-Sonde	Ø 2,3 mm, Länge 3,4 m	Einweg	(VE 10 Stk.)		
MABS GIT Probe	Ø 2,3 mm, Length 3,4 m	disposable	(10/pack)		
Sonda MABS GIT	Ø 2,3 mm, Largo 3,4 m	desechable	(10/unidad)		
Sonde MABS GIT	Ø 2,3 mm, Longueur 3,4 m	usage unique	(10/unité)		
Sonda MABS GIT	Ø 2,3 mm, Lunghezza 3,4 m	monouso	(10/unità)		
80-181-32-04					 Side Fire
MABS-GIT-Sonde	Ø 2,3 mm, Länge 2,3 m	Einweg	(VE 10 Stk.)		
MABS GIT Probe	Ø 2,3 mm, Length 2,3 m	disposable	(10/pack)		
Sonda MABS GIT	Ø 2,3 mm, Largo 2,3 m	desechable	(10/unidad)		
Sonde MABS GIT	Ø 2,3 mm, Longueur 2,3 m	usage unique	(10/unité)		
Sonda MABS GIT	Ø 2,3 mm, Lunghezza 2,3 m	monouso	(10/unità)		

Weitere Informationen entnehmen Sie bitte der separaten Broschüre.

For further information please refer to our separate product brochure.

Encontrará informaciones adicionales en el folleto individual.

Vous trouverez des informations supplémentaires dans la brochure.

Per ulteriori informazioni vedasi il prospetto separato.



MABS-Snare-Sonden „aus ZWEI mach EINS“  
 MABS Snare probes – “TWO in ONE”  
 Sondas MABS Snare – “DOS en UNA”  
 Sondes MABS Snare – «DEUX en UNE»  
 Sonde MABS Snare – “DUE in UNA”

Argon-Beamer-System  
 Argon Beamer System  
 Sistema Argon Beamer  
 Systeme Argon Beamer  
 Sistema Argon Beamer

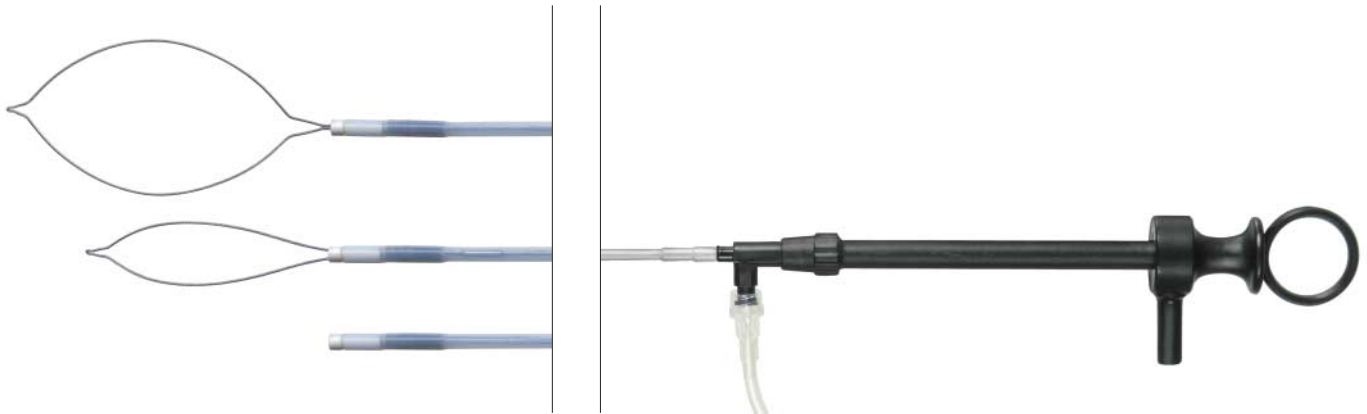

MABS-Snare-Sonden  
 MABS Snare Probes  
 Sondas MABS Snare  
 Sondes MABS Snare  
 Sonde MABS Snare

Art.-Nr. Item No N.º ref. Réf. Codice art.	Bezeichnung Designation Designación Designation Designazione	Ø Ø Ø Ø Ø	Länge Length Longitud Longueur Lunghezza	VE Items/pack UE UE UV
80-181-40-04	MABS TBS Snare	15 mm, multifil., disposable	2.5 mm 1.6 m	5
80-181-41-04	MABS GIT Snare	15 mm, multifil., disposable	2.5 mm 2.3 m	5
80-181-42-04	MABS GIT Snare	30 mm, multifil., disposable	2.5 mm 2.3 m	5
80-181-43-04	MABS GIT Snare	15 mm, monofil., disposable	2.5 mm 2.3 m	5
80-181-44-04	MABS GIT Snare	30 mm, monofil., disposable	2.5 mm 2.3 m	5

Die MABS-Snare-Sonden sind Kombinationssonden, die für die Abtragung von Polypen und eine anschließende Koagulation mittels Argonbeam verwendet werden können.

MABS Snare probes are combination probes allowing you to remove polyps with subsequent argon coagulation of the site.

Las sondas MABS Snare son sondas combinadas, que pueden utilizarse para la remoción de pólipos y una coagulación posterior mediante plasma de gas argón.

Les sondes MABS Snare sont des sondes combinées qui peuvent être utilisées pour l'ablation de polypes suivie d'une coagulation moyennant un faisceau d'argon.

Le sonde MABS Snare sono sonde combinate che consentono la rimozione di polipi con successiva coagulazione ad argon del sito.

Weitere Informationen entnehmen Sie bitte der separaten Broschüre.

For further information please refer to our separate product brochure.

Encontrará informaciones adicionales en el folleto individual.

Vous trouverez des informations supplémentaires dans la brochure.

Per ulteriori informazioni vedasi il prospetto separato.



80-289-40-04 max. 4000 V<sub>p</sub>

4 m/13 ft.

Monopolar Anschlusskabel für KLS-Martin-HF-Geräte  
 Monopolar connecting cable for KLS Martin HF units  
 Cable de conexión monopolar para equipos de AF de KLS Martin  
 Câble de raccordement monopolaire pour appareils HF KLS Martin  
 Cavo di collegamento monopolare per apparecchi AF di KLS Martin



80-289-41-04 max. 4000 V<sub>p</sub>

4 m/13 ft.

Monopolar Anschlusskabel für HF-Geräte mit 3-Pin-Stecker  
 Monopolar connecting cable for HF units with 3-pin plugs  
 Cable de conexión monopolar para equipos de AF con clavija de 3 patillas  
 Câble de raccordement monopolaire pour appareils HF avec fiche à 3 spires  
 Cavo di collegamento monopolare per apparecchi AF con spina a 3-spire

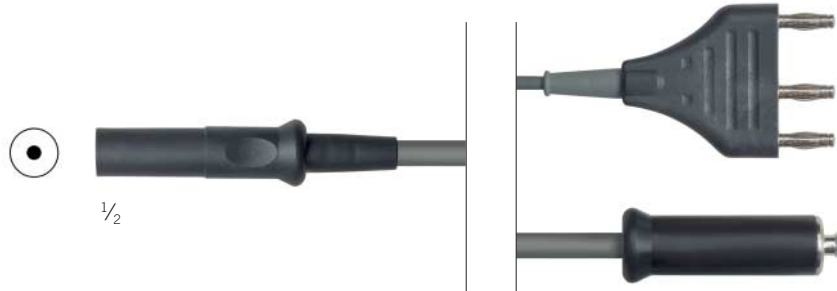

80-181-17-04

MABS-Anschlussleitung für Erbe-Sonden, mit Rundstecker  
 MABS connection cable for Erbe probes, with circular connector  
 Cable de conexión MABS para sondas Erbe, con clavija redonda  
 Câble de connexion MABS pour sondes Erbe, avec connecteur rond  
 Cavo di collegamento MABS per sonda Erbe, con spina tonda



80-181-90-04

MABS-Sterifilter, VE = 50 Stück  
 MABS sterile filter, SU = 50/pack  
 Filtro estéril MABS, UV = 50 piezas  
 Filtre stérile MABS, UC = 50 unités  
 Filtro sterile MABS, UV = 50 pezzi

maxium®



maxium®, maxium® Beamer,  
 maxium® Cart II



KLS Martin ME 411,  
 KLS Martin Beamer MB 181,  
 maxium® Cart II





MABS-Druckminderer mit Schlauch und Schnellkupplung  
2,5 bis 4,5 bar, Schlauchlänge 1 m/3 ft.

MABS pressure reducer with flexible tube and quick-action  
coupling 2.5 to 4.5 bar, tube length: 1 m/3 ft.

Manorreductor MABS con tubo y acoplamiento rápido  
2,5 a 4,5 bar, longitud del tubo: 1 m/3 pies

Décompresseur MABS avec tuyau et raccord pompier  
2,5 à 4,5 bar, longueur de tuyau 1 m/3 ft.

Riduttore di pressione MABS con tubo flessibile e attacco  
rapido da 2,5 a 4,5 bar, lunghezza tubo 1 m/3 ft.

Artikel Item no. Artículo Article Articolo	Norm Standard Norma Norme Norma	Länder Countries Países Pays Paesi
80-181-52-04	DIN 477, Nr. 6	D, A, CH, F, P, E, GR
80-181-53-04	DIN 477, Nr. 10	NL, DK, S, NOR, B
80-181-54-04	UNI 4412	I
80-181-55-04	BS 341, Nr. 3	UK, AUS, MY, IN, TR, former Commonwealth
80-181-56-04	CGA, Nr. 580	USA, MX, TH, South America
80-181-57-04		China

#### 94-179-58-04

Gasflasche mit Füllung Argongas 4.8, 5 ltr.  
Gas bottle with "4.8 quality" argon gas filling, 5 ltr.  
Bombona de gas con relleno de gas argón 4.8, 5 ltr.  
Bouteille de gaz avec remplissage de gaz d'argon 4.8, 5 ltr.  
Bombola di gas con riempimento di gas argon 4.8, 5 ltr.

oder über den örtlichen Lieferanten erhältlich  
or available through your local supplier  
o pueden obtenerse a través del proveedor local  
ou disponibles auprès des fournisseurs locaux  
o disponibili presso il fornitore locale

Bitte besondere Versandvorschriften beachten!  
Please note special shipping regulations!  
¡Rogamos tengan en cuenta las disposiciones especiales de envío!  
Expédition soumise à des dispositions réglementaires particulières!  
Si prega di osservare le particolari prescrizioni per la spedizione!



#### 94-179-59-04

Argon-Gasflasche, ohne Füllung, 5 ltr.  
Argon gas cylinder, empty, 5 ltr.  
Bombona de gas argón, vacía, 5 ltr.  
Bouteille de gaz d'argon, vide, 5 ltr.  
Bombola di gas argon, vuota, 5 ltr.

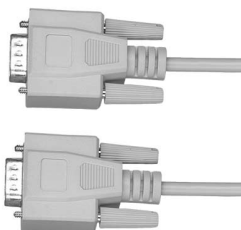

ME 411  
ME CD1

80-181-50-04  
1 m/3 ft.

MABS-Schnittstellenkabel  
MABS interface cable  
Cable de interfaz MABS  
Câble interface MABS  
Cavo interfaccia MABS



80-181-51-04

MABS-Verbindungskabel  
MABS connecting cable  
Cable de conexión MABS  
Câble de connexion MABS  
Cavo di collegamento MABS

#### ME MB 3/ME MB 2/ME MB 1

Fremdgeräte mit dieser  
Steckerverbindung

Third-party devices with this type  
of connector

Aparatos de otros fabricantes con  
esta conexión de enchufe

Appareils externes avec cette  
connexion des prises

Apparecchi di altri produttori con  
questa connessione della spina

Übersicht der MABS-Grundausrüstung  
 Overview of MABS basic equipment  
 Vista general del equipo básico del MABS  
 Vue d'ensemble de l'équipement de base MABS  
 Schema della dotazione di base MABS

Technisches Zubehör		Technical accessories	Accesorios técnicos
<b>Kombinationsmöglichkeit 1:</b>		<b>Combination 1:</b>	<b>Combinación 1:</b>
80-047-00-04	Gerätewagen maxium® Cart II	maxium® Cart II	maxium® Cart II
80-081-00-04	Argon-Beamer-Gerät MB 181 Elektrochirurgie-Gerät ME 411 oder ME MB 3/ME MB 2/ME MB 1	Argon Beamer unit MB 181 Electrosurgical unit ME 411 or ME MB 3/ME MB 2/ME MB 1	Aparato Argon Beamer MB 181 Aparato electroquirúrgico ME MB 3/ME MB 2/ME MB 1
80-181-51-04	MABS-Fußschaltersignalkabel (bei ME MB 3/ME MB 2/ME MB 1)	MABS foot switch signal cable (for ME MB 3/ME MB 2/ME MB 1)	Cable MABS de señal para el interruptor de pie (en ME MB 3/ME MB 2/ME MB 1)
80-181-50-04	MABS-Schnittstellenkabel (bei ME 411)	MABS foot switch signal cable (for ME 411)	Cable de interfaz MABS (en ME 411)
<b>Kombinationsmöglichkeit 2:</b>		<b>Combination 2:</b>	<b>Combinación 2:</b>
80-047-00-04	Gerätewagen maxium® Cart II	maxium® Cart II	maxium® Cart II
80-044-00-04	maxium® Beamer	maxium® Beamer	maxium® Beamer
80-042-00-04	maxium® mit Modul für KLS-Martin- Zubehör, „m“-Version	maxium® with socket module for KLS Martin accessories, “m“-version	maxium® con módulo para accesorios KLS Martin, versión “m“
	alternativ: maxium® „i“-Version oder „e“-Version	alternatively: maxium® “i“- or “e“-version	alternativa: maxium® versión “i” o versión “e”

Druckmindererauswahl (nach Länderstandard)		Selection of pressure reducers (acc. to national standards)	Selección de manorreductores (según los estándares de países)
80-181-52-04	MABS-Druckminderer, DIN 477 Nr. 6, für D, A, CH, F, P, E, GR	MABS pressure reducer, DIN 477 No. 6, for D, A, CH, F, P, E, GR	Manorreductor MABS, DIN 477 Nº. 6, para D, A, CH, F, P, E, GR
80-181-53-04	MABS-Druckminderer, DIN 477 Nr. 10, für NL, DK, S, NOR, B	MABS pressure reducer, DIN 477 No. 10, for NL, DK, S, NOR, B	Manorreductor MABS, DIN 477 Nº. 10, para NL, DK, S, NOR, B
80-181-54-04	MABS-Druckminderer, UNI 4412, für I	MABS pressure reducer, UNI 4412, for I	Manorreductor MABS, UNI 4412, para I
80-181-55-04	MABS-Druckminderer, BS 341 Nr. 3, für GB, AUS, Malaysia, Indien, ehem. Commonwealth, Türkei	MABS pressure reducer, BS 341 No. 3, for GB, AUS, Malaysia, India, former Commonwealth, Turkey	Manorreductor MABS, BS 341 Nº. 3, para GB, AUS, Malasia, India, ex-Comunidad Británica de Naciones, Turquía
80-181-56-04	MABS-Druckminderer, CGA Nr. 580, für USA, Südamerika, Mexiko, Thailand	MABS pressure reducer, CGA No. 580, for USA, South America, Mexico, Thailand	Manorreductor MABS, CGA Nr. 580, para EE.UU., Sudamérica, México, Tailandia
80-181-57-04	MABS-Druckminderer, China	MABS pressure reducer, China	Manorreductor MABS, China

Klinisches Zubehör (starr) für die offene Chirurgie (Ø 5 mm)		Clinical accessories (rigid) for open surgery (Ø 5 mm)	Accesorios clínicos (rígidos) para la cirugía abierta (Ø 5 mm)
80-181-02-04	MABS-Handgriff, für starre Elektroden	MABS handle, for rigid electrodes	Interruptor de mango MABS, para electrodos rígidos
80-181-10-04	MABS-Beam-Elektrode, Arbeitslänge 25 mm	MABS beam electrode, working length 25 mm	Electrodo MABS Beam, longitud de trabajo: 25 mm
80-181-11-04	MABS-Beam-Elektrode, Arbeitslänge 100 mm	MABS beam electrode, working length 100 mm	Electrodo MABS Beam, longitud de trabajo: 100 mm
80-181-13-04	MABS-Lanzetten-Elektrode, Arbeitslänge 25 mm	MABS lancet electrode, working length 25 mm	Electrodo MABS de lanceta, longitud de trabajo: 25 mm
80-181-14-04	MABS-Lanzetten-Elektrode, Arbeitslänge 115 mm	MABS lancet electrode, working length 115 mm	Electrodo MABS de lanceta, longitud de trabajo: 115 mm
80-181-15-04	MABS-Nadel-Elektrode, Arbeitslänge 40 mm	MABS needle electrode, working length 40 mm	Electrodo MABS de aguja, longitud de trabajo: 40 mm
80-181-16-04	MABS-Nadel-Elektrode, Arbeitslänge 115 mm	MABS needle electrode, working length 115 mm	Electrodo MABS de aguja, longitud de trabajo: 115 mm



Accessoires techniques		Accessori tecnici	
<b>Combinaison 1:</b>		<b>Combinazione 1:</b>	
80-047-00-04	maxium® Cart II	80-047-00-04	maxium® Cart II
80-081-00-04	Appareil diffuseur à argon MB 181 Appareil électrochirurgical ME 411 ou ME MB 3/ME MB 2/ME MB 1	80-081-00-04	Apparecchio Argon Beamer MB 181 Apparecchio elettrochirurgico ME 411 o ME MB 3/ME MB 2/ME MB 1
80-181-51-04	Câble signal MABS pour interrupteur à pied (pour ME MB 3/ME MB 2/ME MB 1)	80-181-51-04	Cavo MABS di segnale dell'interruttore a pedale (per ME MB 3/ME MB 2/ME MB 1)
80-181-50-04	Câble interface MABS (pour ME 411)	80-181-50-04	Cavo interfaccia MABS (per ME 411)
<b>Combinaison 2:</b>		<b>Combinazione 2:</b>	
80-047-00-04	maxium® Cart II	80-047-00-04	maxium® Cart II
80-044-00-04	maxium® Beamer	80-044-00-04	maxium® Beamer
80-042-00-04	maxium® avec module de connexion pour accessoires KLS Martin, version «m»	80-042-00-04	maxium® con modulo per accessori KLS Martin, versione "m"
	ou bien: maxium® version « i » ou « e »		come alternativa: maxium® versione "i" o versione "e"

Choix de décompresseurs (selon les standards nationaux)		Selezione dei riduttori di pressione (in base agli standard nazionali)	
80-181-52-04	Décompresseur MABS, DIN 477 n° 6, pour D, A, CH, F, P, E, GR	80-181-52-04	Riduttore di pressione MABS, DIN 477 N. 6, per D, A, CH, F, P, E, GR
80-181-53-04	Décompresseur MABS, DIN 477 n° 10, pour NL, DK, S, NOR, B	80-181-53-04	Riduttore di pressione MABS, DIN 477 N. 10, per NL, DK, S, NOR, B
80-181-54-04	Décompresseur MABS, UNI 4412, pour I	80-181-54-04	Riduttore di pressione MABS, UNI 4412, per I
80-181-55-04	Décompresseur MABS, BS 341 n° 3, pour GB, AUS, Malaisie, Inde, ancien Commonwealth, Turquie	80-181-55-04	Riduttore di pressione MABS, BS 341 N. 3, per GB, AUS, Malesia, India, ex. Commonwealth, Turchia
80-181-56-04	Décompresseur MABS, CGA n° 580, pour USA, Amérique du sud, Mexique, Thaïlande	80-181-56-04	Riduttore di pressione MABS, CGA N. 580, per USA, Sudamerica, Messico, Thailandia
80-181-57-04	Décompresseur MABS, Chine	80-181-57-04	Riduttore di pressione MABS, China

Accessoires cliniques (rigides) pour la chirurgie ouverte (Ø 5 mm)		Accessori clinici (rigidi) per la chirurgia aperta (Ø 5 mm)	
80-181-02-04	Poignée MABS, pour électrodes rigides	80-181-02-04	Impugnatura MABS, per elettrodi rigidi
80-181-10-04	Electrode du diffuseur MABS, longueur de travail 25 mm	80-181-10-04	Elettrodo MABS Beam, lunghezza di lavoro 25 mm
80-181-11-04	Electrode du diffuseur MABS, longueur du travail 100 mm	80-181-11-04	Elettrodo MABS Beam, lunghezza di lavoro 100 mm
80-181-13-04	Electrode à couteau MABS, longueur de travail 25 mm	80-181-13-04	Elettrodo a lancetta MABS, lunghezza di lavoro 25 mm
80-181-14-04	Electrode à couteau MABS, longueur de travail 115 mm	80-181-14-04	Elettrodo a lancetta MABS, lunghezza di lavoro 115 mm
80-181-15-04	Electrode à aiguille MABS, longueur de travail 40 mm	80-181-15-04	Elettrodo ad ago MABS, lunghezza di lavoro 40 mm
80-181-16-04	Electrode à aiguille MABS, longueur de travail 115 mm	80-181-16-04	Elettrodo ad ago MABS, lunghezza di lavoro 115 mm

Übersicht der MABS-Grundausrüstung  
 Overview of MABS basic equipment  
 Vista general del equipo básico del MABS  
 Vue d'ensemble de l'équipement de base MABS  
 Schema della dotazione di base MABS

	Klinisches Zubehör (starr) für die laparoskopische Chirurgie (Ø 5 mm)	Clinical accessories (rigid) for laparoscopic surgery	Accesorios clínicos (rígidos) para la cirugía laparoscópica
80-181-02-04	MABS-Handgriff, für starre Elektroden	MABS handle, for rigid electrodes	Interruptor de mango MABS, para electrodos rígidos
80-181-12-04	MABS-Beam-Elektrode, Arbeitslänge 320 mm	MABS beam electrode, working length 320 mm	Electrodo MABS Beam, longitud de trabajo: 320 mm

	Klinisches Zubehör (flexibel) für die endoskopische Chirurgie	Clinical accessories (flexible) for endoscopic surgery	Accesorios clínicos (flexibles) para la cirugía endoscópica
80-181-30-04	MABS-Anschlussleitung	MABS connection cable	Cable de conexión MABS
80-181-25-04	MABS-TBS-Sonde, flexibel, Einweg (Ø 1,8 mm/Länge 1,6 m)	MABS TBS probe, flexible, disposable, Ø 1.8 mm, working length 1.6 m	Sonda MABS TBS, flexible, desechable, Ø 1,8 mm / longitud de trabajo: 1,6 m
80-181-23-04	MABS-GIT-Sonde, flexibel, wiederverwendbar (Ø 2,3 mm/Länge 2,3 m)	MABS GIT probe, flexible, reusable, Ø 2.3 mm, working length 2.3 m	Sonda MABS GIT, flexible, reutilizable, Ø 2,3 mm / longitud de trabajo: 2,3 m
80-181-24-04	MABS-GIT-Sonde, flexibel, wiederverwendbar (Ø 3,2 mm/Länge 2,3 m)	MABS GIT probe, flexible, reusable, Ø 3.2 mm, working length 2.3 m	Sonda MABS GIT, flexible, reutilizable, Ø 3,2 mm / longitud de trabajo: 2,3 m
	alternativ: Einwegsonden, flexibel, siehe Seite 110	alternatively: Disposable probes, flexible, see page 110	alternativa: Sondas desechables, flexibles, véase página 110

	Optional	Optional	Accesorios opcionales
80-181-51-04	MABS-Fußschaltersignalkabel	MABS foot switch signal cable	Cable de señalización para el interruptor de pedal MABS
80-181-50-04	MABS-Schnittstellenkabel (nur für ME 411)	MABS interface cable (for ME 411 only)	Cable de interfaz serial MABS (sólo para ME 411)
80-821-02-04	MABS-Fußschalter (monopolar), schwere Ausführung	MABS foot switch (monopolar), heavy-duty design	Interruptor de pedal MABS (monopolar), modelo pesado
80-811-30-04	MABS-Fußschalter (monopolar), leichte Ausführung	MABS foot switch (monopolar), light-duty design	Interruptor de pedal MABS (monopolar), modelo ligero
80-294-40-04	Anschlusskabel für Einmal-Neutralelektroden	Connection cable for disposable neutral electrodes	Cable de conexión para electrodos neutros de uso único
80-181-90-04	Sterilfilter, VE = 50 Stck.	Sterile filter, SU = 50/pack	Filtro estéril, UV = 50 piezas

**Hinweise:**

1. Für die Gewährleistung eines kontinuierlichen OP-Ablaus sind die klinikinternen Aufbereitungszyklen zu berücksichtigen. Das Zubehör ist vor diesem Hintergrund entsprechend zu quantifizieren.

2. Argongas 4.8 in handelsüblicher Flaschenform (5 l oder 10 l) ist bei den örtlichen Lieferanten erhältlich.

**Notes:**

1. Smooth OR processes require the seamless integration of the hospital's instrument processing cycles and, consequently, the availability of a sufficient quantity of accessories.

2. "4.8 quality" argon gas may be obtained from local suppliers (to be delivered in commonly used 5-l or 10-l cylinders).

**Indicaciones:**

1. Para garantizar el desarrollo continuado de las secuencias en el quirófano, deberán tenerse en cuenta los ciclos de procesamiento internos de la clínica. Las cantidades de accesorios deberán planificarse en consecuencia.

2. El gas argón 4.8 se obtiene de los proveedores locales en las bombonas de gas usuales (de 5 ó 10 litros).



Accessoires cliniques (rigides) pour la chirurgie laparoscopique		Accessori clinici (rigidi) per la chirurgia laparoscopica	
80-181-02-04	Poignée MABS, pour électrodes rigides	Impugnatura MABS, per elettrodi rigidi	
80-181-12-04	Électrode du diffuseur MABS, longueur de travail 320 mm	Elettrodo MABS Beam, lunghezza di lavoro 320 mm	

Accessoires cliniques (flexibles) pour la chirurgie endoscopique		Accessori clinici (flessibili) per la chirurgia endoscopica	
80-181-30-04	Conduite de raccord MABS	Cavo di collegamento MABS	
80-181-25-04	Sonde MABS TBS, flexible, à usage unique , Ø 1,8 mm/longueur de travail 1,6 m	Sonda MABS TBS, flessibile, monouso Ø 1,8 mm/lunghezza di lavoro 1,6 m	
80-181-23-04	Sonde MABS GIT, flexible, réutilisable Ø 2,3 mm/longueur de travail 2,3 m	Sonda MABS GIT, flessibile, riutilizzabile Ø 2,3 mm/lunghezza di lavoro 2,3 m	
80-181-24-04	Sonde MABS GIT, flexible, réutilisable Ø 3,2 mm/longueur de travail 2,3 m	Sonda MABS GIT, flessibile, riutilizzabile Ø 3,2 mm/lunghezza di lavoro 2,3 m	
	ou bien: Sondes à usage unique, flexibles, voir page 110	come alternativa: Sonde monouso, flessibili, vedi pagina 110	

En option		Opzioni	
80-181-51-04	Câble signal pour interrupteur à pedal MABS	Cavo di segnale per l'interruttore a pedale MABS	
80-181-50-04	Câble interface MABS (uniquement pour ME 411)	Cavo interfaccia MABS (solo per ME 411)	
80-821-02-04	Interrupteur à pied MABS (monopolaire), modèle lourd	Interruttore a pedale MABS (monopolare), esecuzione pesante	
80-811-30-04	Interrupteur à pied MABS (monopolaire), modèle léger	Interruttore a pedale MABS (monopolare), esecuzione leggera	
80-294-40-04	Câble raccord pour des électrodes neutres à usage unique	Cavo di collegamento per elettrodi neutri monouso	
80-181-90-04	Filtre stérile, UC = 50 pièces	Filtro sterile, UV = 50 pezzi	

#### Indications:

- Il convient de tenir compte des cycles de traitement cliniques internes pour assurer la continuité des processus en salle d'opération. Par conséquent, il faudra veiller à toujours disposer d'accessoires en nombre suffisant.
- Le gaz d'argon 4.8 est disponible dans des bouteilles à gaz usuelles dans le commerce (5 l ou 10 l) auprès des fournisseurs locaux.

#### Avvertenze

- Per garantire un intervento operatorio continuato, devono essere considerati i cicli di preparazione interni. Gli accessori devono essere quantificati in base a queste esigenze.
- Il gas argon 4.8 in bombole comuni (da 5 o 10 litri) può essere acquistato presso i fornitori locali.



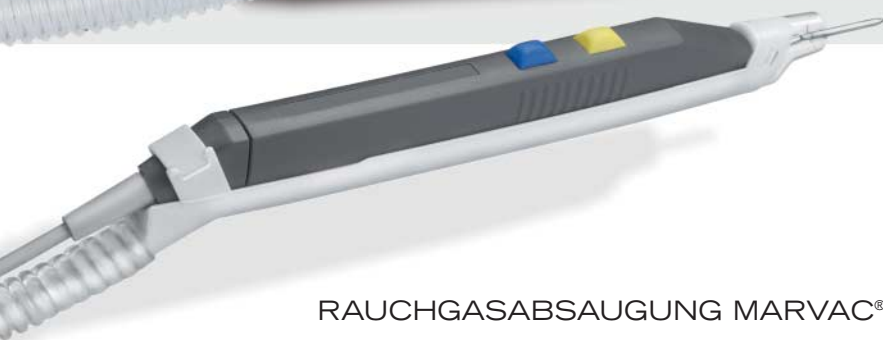

RAUCHGASABSAUGUNG MARVAC®  
UND ZUBEHÖR

MARVAC® SMOKE EVACUATOR  
AND ACCESSORIES

EVACUACIÓN DE GASES DE COMBUSTIÓN MARVAC®  
Y ACCESORIOS

EVACUATEUR DE FUMÉE MARVAC®  
ET ACCESSOIRES

ASPIRATORE DI FUMO MARVAC®  
E ACCESSORI

125-130

# marVAC®



- |   |   |  |   |
|---|---|--|---|
| <input checked="" type="checkbox"/> Effektiv    | <input checked="" type="checkbox"/> Effective | <input checked="" type="checkbox"/> Efectivo   | <input checked="" type="checkbox"/> Performant  |
| <input checked="" type="checkbox"/> Ergonomisch | <input checked="" type="checkbox"/> Ergonomic | <input checked="" type="checkbox"/> Ergonómico | <input checked="" type="checkbox"/> Ergonomique |
| <input checked="" type="checkbox"/> Sicher      | <input checked="" type="checkbox"/> Safe      | <input checked="" type="checkbox"/> Seguro     | <input checked="" type="checkbox"/> Sûr         |

marVAC® – das innovative System zur effizienten Absaugung von Rauchgasen

marVAC® – the innovative system for efficient removal of surgical plume

marVAC® – el sistema innovador para la evacuación eficiente de gases de combustión

marVAC® – le système innovatif pour l'évacuation efficace des fumées

Freie Sicht und maximale Sicherheit am OP-Feld – Rauch gehört der Vergangenheit an

Unobstructed view and maximum safety at the surgical site – smoke is a thing of the past

Visibilidad total y seguridad máxima campo operatorio – los humos son cosa del pasado

Visibilité et sécurité maximales au champ opératoire – la fumée fait partie du passé !

marVAC®		marVAC®		marVAC®	
Produktbeschreibung		Product Description		Descripción de producto	
80-060-00-04	Rauchgasabsaugung marVAC® 220-240 V inkl. Hauptfilter (Art.-Nr. 80-060-01-04) und Verbindungssatz für HF-Grossgeräte	marVAC® smoke evacuator, 220-240 V, incl. main filter (item no. 80-060-01-04) and connection kit for major electrosurgical units	marVAC® smoke evacuator, 220-240 V, incl. main filter (item no. 80-060-01-04) and connection kit for major electrosurgical units	Evacuación de gases de combustión marVAC®, 220 – 240 V, incl. filtro principal (n.º ref. 80-060-01-04) y juego de conexión para gran aparatos	Evacuación de gases de combustión marVAC®, 220 – 240 V, incl. filtro principal (n.º ref. 80-060-01-04) y juego de conexión para gran aparatos
80-060-00-10	Rauchgasabsaugung marVAC® 100-127 V inkl. Hauptfilter (Art.-Nr. 80-060-01-04) und Verbindungssatz für HF-Grossgeräte	marVAC® smoke evacuator, 100-127 V, incl. main filter (item no. 80-060-01-04) and connection kit for major electrosurgical units	marVAC® smoke evacuator, 100-127 V, incl. main filter (item no. 80-060-01-04) and connection kit for major electrosurgical units	Evacuación de gases de combustión marVAC®, 100 – 127 V, incl. filtro principal (n.º ref. 80-060-01-04) y juego de conexión para gran aparatos	Evacuación de gases de combustión marVAC®, 100 – 127 V, incl. filtro principal (n.º ref. 80-060-01-04) y juego de conexión para gran aparatos
80-061-00-04	Rauchgasabsaugung marVAC® mit <b>LAP-Modus</b> , 220-240 V inkl. Hauptfilter (Art.-Nr. 80-060-01-04) und Verbindungssatz für HF-Grossgeräte	marVAC® smoke evacuator with <b>LAP mode</b> , 220-240 V, incl. main filter (item no. 80-060-01-04) and connection kit for major electrosurgical units	marVAC® smoke evacuator with <b>LAP mode</b> , 220-240 V, incl. main filter (item no. 80-060-01-04) and connection kit for major electrosurgical units	Evacuación de gases de combustión marVAC® con <b>modo LAP</b> , 220 – 240 V, incl. filtro principal (n.º ref. 80-060-01-04) y juego de conexión para gran aparatos	Evacuación de gases de combustión marVAC® con <b>modo LAP</b> , 220 – 240 V, incl. filtro principal (n.º ref. 80-060-01-04) y juego de conexión para gran aparatos
80-061-00-10	Rauchgasabsaugung marVAC® mit <b>LAP-Modus</b> , 100-127 V inkl. Hauptfilter (Art.-Nr. 80-060-01-04) und Verbindungssatz für HF-Grossgeräte	marVAC® smoke evacuator with <b>LAP mode</b> , 100-127 V, incl. main filter (item no. 80-060-01-04) and connection kit for major electrosurgical units	marVAC® smoke evacuator with <b>LAP mode</b> , 100-127 V, incl. main filter (item no. 80-060-01-04) and connection kit for major electrosurgical units	Evacuación de gases de combustión marVAC® con <b>modo LAP</b> , 100 – 127 V, incl. filtro principal (n.º ref. 80-060-01-04) y juego de conexión para gran aparatos	Evacuación de gases de combustión marVAC® con <b>modo LAP</b> , 100 – 127 V, incl. filtro principal (n.º ref. 80-060-01-04) y juego de conexión para gran aparatos



Rauchgasabsaugung marVAC®  
 Smoke evacuator marVAC®  
 Evacuación de gases de combustión marVAC®  
 Evacuateur de fumée marVAC®  
 Aspiratore di fumo marVAC®



maxium®  
 &  
 marVAC®  
 &  
 maxium® Cart II

- ✓ Effettivo
- ✓ Ergonomico
- ✓ Sicuro

marVAC® – il sistema innovativo per l'aspirazione efficace di gas di combustione

Visibilità totale e massima sicurezza al campo operatorio – il fumo è cosa passata

Weitere Informationen entnehmen Sie bitte der separaten Broschüre.

For further information please refer to our separate product brochure.

Encontrará informaciones adicionales en el folleto individual.

Vous trouverez des informations supplémentaires dans la brochure.

Per ulteriori informazioni vedasi il prospetto separato.



marVAC®		marVAC®	
	Description du produit		Descrizione del prodotto
80-060-00-04	Evacuateur de fumée marVAC®, 220 – 240 V, y compris filtre principal (réf. 80-060-01-04) et set de connexion pour grands appareils		Aspiratore di fumo marVAC®, 220 – 240 V, incl. filtro principale (codice art. 80-060-01-04) e set di collegamento per apparecchi grandi
80-060-00-10	Evacuateur de fumée marVAC®, 100 – 127 V, y compris filtre principal (réf. 80-060-01-04) et set de connexion pour grands appareils		Aspiratore di fumo marVAC®, 100 – 127 V, incl. filtro principale (codice art. 80-060-01-04) e set di collegamento per apparecchi grandi
80-061-00-04	Evacuateur de fumée marVAC® avec <b>mode LAP</b> , 220 – 240 V, y compris filtre principal (réf. 80-060-01-04) et set de connexion pour grands appareils		Aspiratore di fumo marVAC®, 220 – 240 V, con <b>modalità LAP</b> , incl. filtro principale (codice art. 80-060-01-04) e set di collegamento per apparecchi grandi
80-061-00-10	Evacuateur de fumée marVAC® avec <b>mode LAP</b> , 100 – 127 V, y compris filtre principal (réf. 80-060-01-04) et set de connexion pour grands appareils		Aspiratore di fumo marVAC®, 100 – 127 V, con <b>modalità LAP</b> , incl. filtro principale (codice art. 80-060-01-04) e set di collegamento per apparecchi grandi

Rauchgasabsaugung marVAC® und Zubehör  
 marVAC® smoke evacuator and accessories  
 Evacuación de gases de combustión marVAC® y accesorios  
 Evacuateur de fumée marVAC® et accessoires  
 Aspiratore di fumo marVAC® e accessori

Zubehör		Accessories	Accesorios
Individuelle Zubehörteile		Optional accessories	Accesorios opcionales
80-060-01-04	Hauptfilter für Rauchgasabsaugung marVAC® (ULPA-Standard)	Main filter for marVAC® smoke evacuator (ULPA standard)	Filtro principal para la evacuación de gases de combustión marVAC® (estándar ULPA)
80-811-50-04	Einpedalfußschalter zur manuellen Aktivierung	Single-pedal foot switch for foot activation	Interruptor de pie de pedal simple para la activación con el pie
80-060-06-04	Adapter zum Anschluss an eine zentrale OP-Absaugung (Ø 22 mm)	Adapter for connection to central evacuation system (Ø 22 mm)	Adaptador para la conexión al sistema de evacuación central del quirófano (Ø 22 mm)
Verbindungsoptionen zur automatischen Aktivierung (HF-Generator oder Laser)		Connection options for automatic activation (via HF generator or laser)	Opciones de conexión para la activación automática (a través del generador de AF o de un equipo láser)
80-091-01-04	MCB-Verbindungskabel (maxium® und marVAC®)	MCB connecting cable (maxium® and marVAC®)	Cable de conexión MCB (maxium® y marVAC®)
80-060-05-04	Adapter zur Netzstromerkennung (ISA-Verbindung), inkl. Verbindungskabel	Adapter for mains current detection (ISA connection), incl. connecting cable	Adaptador para la detección de la corriente de red (conexión ISA), incl. capuchón de fijación
76-100-60-04	Verlängerungskabel marVAC®, MCO-Laser	Extension cable for marVAC®, MCO laser	Cable de prolongación para marVAC®, láser MCO
80-091-02-04	Verbindungskabel ME MB 2/3 mit marVAC®	Connection cable ME MB 2/3 with marVAC®	Cable de conexión ME MB 2/3 con marVAC®
Weiteres Zubehör für die Rauchgasabsaugung		Additional accessories for marVAC® smoke evacuator	Accesorios adicionales para el evacuador de gases de combustión marVAC®
79-225-02-04	Trichter, abgeflacht, Verbindung Ø 22 mm, 50 Mal autoklavierbar bei max. 134 °C	Funnel, flattened, connector Ø 22 mm, 50 times autoclavable at max. 134°C (273.2°F)	Embudo, aplanado, conexión Ø 22 mm, autoclavable 50 veces a máx. 134 °C
79-225-03-04	Absaugrohr für Absaugschlauch Ø 22 mm, 50 Mal autoklavierbar bei max. 134 °C	Suction tube for suction hose, Ø 22 mm, 50 times autoclavable at max. 134°C (273.2°F)	Tubo de aspiración para la manguera de aspiración de Ø 22 mm, autoclavable 50 veces a máx. 134 °C
79-225-06-04	Schlauchverbinder Ø 22 mm auf Ø 10 mm (m), 50 Mal autoklavierbar bei max. 134 °C	Hose coupling, Ø 22 mm (f) and Ø 10 mm, 50 times autoclavable at max. 134°C (273.2°F)	Pieza de unión para mangueras, Ø 22 mm a Ø 10 mm, autoclavable 50 veces a máx. 134 °C
79-225-07-04	Schlauchverbinder Ø 22 mm auf Ø 22 mm (m), 50 mal autoklavierbar bei max. 134 °C	Hose coupling, Ø 22 mm (f) and Ø 22 mm, (50 times autoclavable at max. 134°C (273.2°F)	Pieza de unión para mangueras, Ø 22 mm a Ø 22 mm, autoclavable 50 veces a máx. 134 °C
79-225-08-04	Absaugschlauch Ø 22 mm, Länge = 3 m, 50 Mal autoklavierbar bei max. 134 °C	Suction hose, Ø 22 mm, length = 3 m, 50 times autoclavable at max. 134°C (273.2°F)	Manguera de aspiración, Ø 22 mm, longitud = 3 m, autoclavable 50 veces a máx. 134 °C
79-225-09-04	Absaugschlauch Ø 10 mm, Länge = 2 m, 50 Mal autoklavierbar bei max. 134 °C	Suction hose, Ø 10 mm, length = 2 m, 50 times autoclavable at max. 134°C (273.2°F)	Manguera de aspiración, Ø 10 mm, longitud = 2 m, autoclavable 50 veces a máx. 134 °C
79-225-10-04	Steriler Absaugschlauch Ø 22 mm, zur Einmalverwendung (Verpackungseinheit = 25 Stück)	Suction hose, sterile, Ø 22 mm, single-use (pack of 25 items)	Manguera de aspiración, estéril, Ø 22 mm, de un solo uso (unidad de embalaje = 25 unidades)
79-225-11-04	Vorfilter (HEPA-Standard), Ø 22 mm, steril, zum Einmalgebrauch (Verpackungseinheit = 20 Stück)	Prefilter (HEPA standard), Ø 22 mm, sterile, single-use (pack of 20 items)	Filtro previo (estándar HEPA), Ø 22 mm, estéril, de un solo uso (unidad de embalaje = 20 unidades)

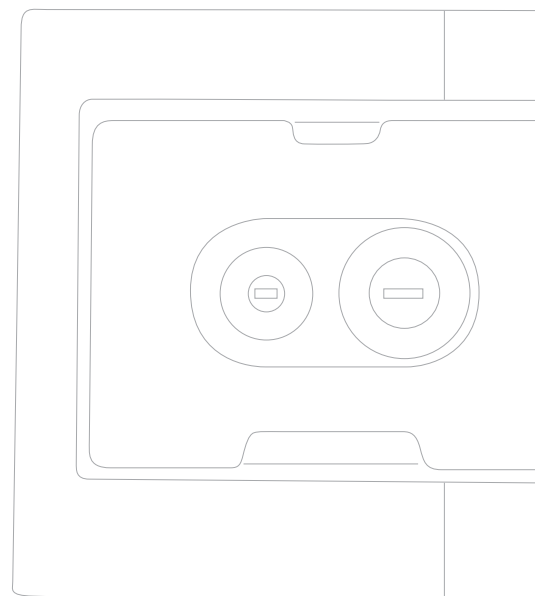



Accessoires		Accessori	
Accessoires en option		Accessori individuali	
80-060-01-04	Filtre principal pour évacuateur de fumée (norme ULPA)	Filtro principale per l'aspiratore di fumo marVAC® (standard ULPA)	
80-811-50-04	Interrupteur à une pédale pour activation à l'aide d'une pédale	Interruttore monopedale per l'attivazione a pedale	
80-060-06-04	Adaptateur de raccordement à un système central d'évacuation (Ø 22 mm)	Collegamento all'aspirazione centralizzata della sala operatoria (Ø 22 mm)	
Options de connexion pour activation automatique (via générateur HF ou laser)		Opzioni di collegamento per l'attivazione automatica (tramite generatore AF o apparecchio laser)	
80-091-01-04	Câble de connexion MCB (maxium® et marVAC®)	Cavo di collegamento MCB (maxium® e marVAC®)	
80-060-05-04	Adaptateur de détection de courant secteur (connexion ISA), câble de connexion compris	Adattatore di rilevamento della corrente di rete (collegamento ISA), compreso cavo di collegamento	
76-100-60-04	Rallonge marVAC®, laser MCO	Cavo di prolunga per marVAC®, laser MCO	
80-091-02-04	Câble de connexion ME MB 2/3 avec marVAC®	Cavo di collegamento ME MB 2/3 con marVAC®	
Autres accessoires pour évacuateur de fumée marVAC®		Ulteriori accessori per l'aspirazione di fumo marVAC®	
79-225-02-04	Entonnoir, aplati, raccord Ø 22 mm, 50 x autoclavable à max. 134 °C	Imbuto, spianato, collegamento di Ø 22 mm, autoclavabile per 50 volte ad una temperatura di max. 134 °C	
79-225-03-04	Tube d'aspiration pour tuyau d'aspiration Ø 22 mm, 50 x autoclavable à max. 134 °C	Tubo di aspirazione per tubo flessibile di aspirazione di Ø 22 mm, autoclavabile per 50 volte ad una temperatura di max. 134 °C	
79-225-06-04	Raccord de tuyau Ø 22 mm sur Ø 10 mm, 50 x autoclavable à max. 134 °C	Raccordo per tubo flessibile di Ø 22 mm su Ø 10 mm, autoclavabile per 50 volte ad una temperatura di max. 134 °C	
79-225-07-04	Raccord de tuyau Ø 22 mm sur Ø 22 mm, 50 x autoclavable à max. 134 °C	Raccordo per tubo flessibile di Ø 22 mm su Ø 22 mm, autoclavabile per 50 volte ad una temperatura di max. 134 °C	
79-225-08-04	Tuyau d'aspiration Ø 22 mm, longueur = 3 m, 50 x autoclavable à max. 134 °C	Tubo flessibile di aspirazione di Ø 22 mm, lunghezza = 3 m, autoclavabile per 50 volte ad una temperatura di max. 134 °C	
79-225-09-04	Tuyau d'aspiration Ø 10 mm, longueur = 2 m, 50 x autoclavable à max. 134 °C	Tubo flessibile di aspirazione di Ø 10 mm, lunghezza = 2 m, autoclavabile per 50 volte ad una temperatura di max. 134 °C	
79-225-10-04	Tuyau d'aspiration, stérile, Ø 22 mm, à usage unique (UE = 25 pièces)	Tubo flessibile di aspirazione, sterile, Ø 22 mm, monouso (unità di imballaggio = 25 unità)	
79-225-11-04	Préfiltre (norme HEPA), Ø 22 mm, stérile, à usage unique (UE = 20 pièces)	Prefiltro (standard HEPA), Ø 22 mm, sterile, monouso (unità di imballaggio = 20 unità)	

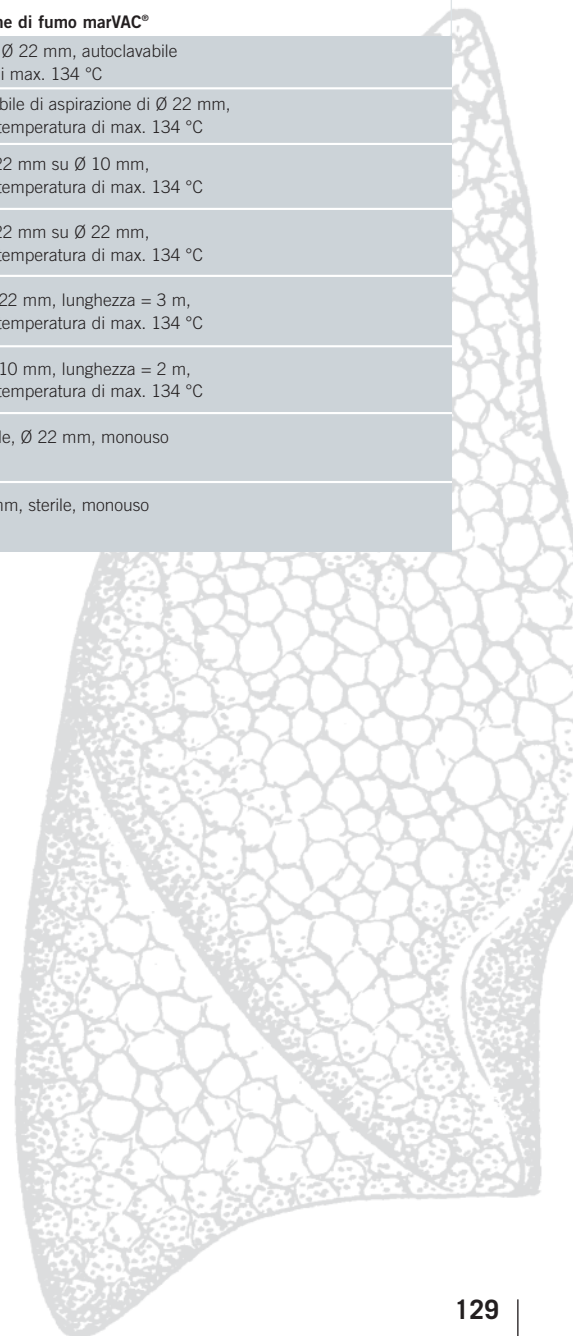
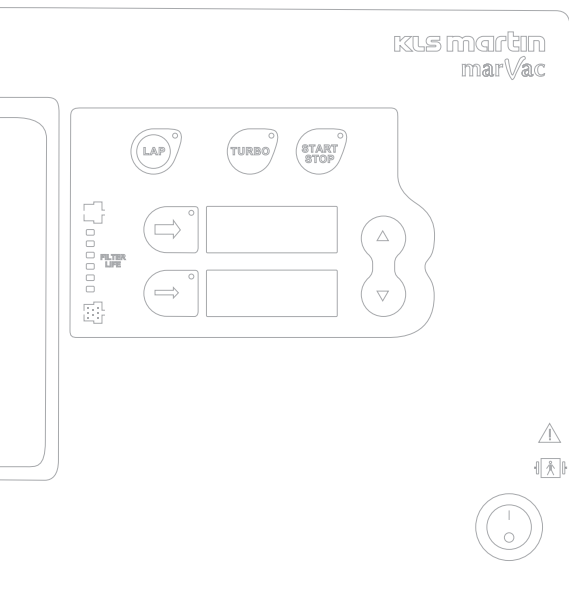



80-060-03-04 *max. 4100 V<sub>p</sub>* **STERILE|EO**

Elektrodenhandgriff mit Elektrode Ø 2,4 mm und 3-Pin-Stecker mit aufgesetztem Clip-on-Applikator, steril, zum Einmalgebrauch, Schlauchlänge = 3 m, Schlauchdurchmesser 22 mm (Verpackungseinheit = 12 Stück)

Electrode handle with electrode Ø 2.4 mm and 3-pin plug, with attached clip-on applicator, sterile, for single use only, hose length 3 m, hose diameter 22 mm (12 items/pack)

Mango portaelectrodos con electrodo de Ø 2,4 mm y clavija de tres alfileres, con aplicador clip-on colocado, estéril, de un solo uso, longitud de la manguera = 3 m, diámetro de la manguera 22 mm (12 unidades/envase)

Manche porte-électrode avec électrode Ø 2,4 mm et fiche à 3 broches, avec applicateur « clip-on » sur le dessus, stérile, à usage unique, longueur du tuyau = 3 m, diamètre du tuyau 22 mm (unité d'emballage = 12 pièces)

Impugnatura per elettrodi con elettrodo Ø 2,4 mm e spina a 3 pin, con applicatore clip-on applicato, sterile, monouso, lunghezza tubo flessibile 3 m, diametro tubo flessibile 22 mm (unità di imballaggio = 12 pezzi)



80-060-02-04 *max. 4000 V<sub>p</sub>* **STERILE|EO**

Clip-on-Applikator, steril, zum Einmalgebrauch, Schlauchlänge = 3 m, Ø 22 mm zur Verwendung mit den wiederverwendbaren Elektrodenhandgriffen KLS Martin 80-217-XX und 80-210-12-04 (Verpackungseinheit = 12 Stück)\*

Clip-on applicator, sterile, single-use, tubing length 3 m, Ø 22 mm, for use with the reusable KLS Martin electrode handles 80-217-XX and 80-210-12-04 (12 items/pack)\*

Aplicador "clip-on", estéril, de un solo uso, longitud de manguera 3 m, Ø 22 mm, a utilizar con los mangos portaelectrodos reutilizables de KLS Martin 80-217-XX y 80-210-12-04 (UE = 12 unidades)\*

Applicateur « clip-on », stérile, à usage unique, longueur du tuyau 3 m, Ø 22 mm, pour utilisation avec porte-électrode à usage multiple KLS Martin 80-217-XX et 80-210-12-04 (UE = 12 pièces)\*

Applicatore "clip-on", sterile, monouso, lunghezza tubo flessibile 3 m, Ø 22 mm, da usare con le impugnature riutilizzabili per elettrodi KLS Martin 80-217-XX e 80-210-12-04 (UV = 12 unità)\*

\* Die Elektrodenhandgriffe sind nicht im Lieferumfang enthalten und müssen separat bestellt werden.

The electrode handles are not included in the scope of supply and therefore must be ordered separately.

Los mangos portaelectrodos no forman parte de las prestaciones del suministro, debiéndolos encargar por separado.

Les manches porte-électrode ne sont pas comprises dans la livraison et doivent être commandées séparément.

Le impugnatura per elettrodi non sono comprese nella fornitura e devono essere ordinate separatamente.



NERVSTIMULATOR NERVSCOUT  
NERVSCOUT NERVE STIMULATOR  
ESTIMULADOR DE NERVIOS NERVSCOUT  
NEUROSTIMULATEUR NERVSCOUT  
NEUROSTIMOLATORE NERVSCOUT

131-133



Der Nervstimulator dient der intraoperativen Differenzierung von Nerven und Muskeln in elektrisch stimulierbaren neuromuskulären Gewebestrukturen.

- Verringerung des Verletzungsrisikos
- Optimierung des Operationsergebnisses

Das Gerät kann als reiner **Stand-alone-Nervstimulator** oder in Kombination mit einem HF-Chirurgiegerät als z.B. **Sphinktertester** verwendet werden.

The nerve stimulator lets you easily differentiate between nerves and muscles in neuromuscular tissue structures that can be stimulated with electric current.

- Reduction of the risk of injury
- Optimization of the surgical outcome

The device can be used either as a **stand-alone nerve stimulator** or in conjunction with a high-frequency surgical unit, e.g. as a **sphincter tester**.

El estimulador de nervios sirve para la diferenciación intraoperativa de nervios y músculos en estructuras de tejidos neuromusculares eléctricamente estimulables.

- Reducción del riesgo de lesión
- Optimización del resultado de la intervención

El aparato puede utilizarse como **estimulador de nervios en funcionamiento autónomo** o en combinación con un aparato de cirugía de AF empleándose, por ejemplo, como **probadador de esfínteres**.

	Bestelldaten	Ordering Data	Datos de pedido
80-065-00-04	NervScout	NervScout	NervScout
80-217-01-04	Elektroden-Handgriff mit 1 Taste, 4 m Kabel	Electrode handle with 1 button, 4-m cable	Mango portaelectrodos con 1 con mutador, 4 m de cable
80-217-03-04	NeuroPen-Handgriff mit 3 Tasten, 4 m Kabel	NeuroPen handle with 3 buttons, 4-m cable	Mango NeuroPen con 3 con mutadores, 4 m de cable
80-220-00-04	Elektroden-Handgriff ohne Taste, 4 m Kabel	Electrode handle without button, 4-m cable	Mango portaelectrodos sin con mutador, 4 m de cable
80-565-01-04	Stimulationselektrode (versilbert), Ø 1 mm	Stimulation electrode (silver-plated), Ø 1 mm	Electrodo de estimulación (plateado), 1 mm Ø
80-565-02-04	Stimulationselektrode (versilbert), Ø 2 mm	Stimulation electrode (silver-plated), Ø 2 mm	Electrodo de estimulación (plateado), 2 mm Ø
80-565-03-04	Stimulationselektrode (versilbert), Ø 3 mm	Stimulation electrode (silver-plated), Ø 3 mm	Electrodo de estimulación (plateado), 3 mm Ø
80-181-51-04*	MABS-Verbindungskabel, 1,2 m	MABS connecting cable, 1.2 m	Cable de conexión MABS, 1,2 m
80-065-01-04*	NervScout-Neutralelektroden-Verbindungskabel "I", 1,2 m	NervScout neutral electrode connecting cable, "I", 1.2 m	Cable de conexión NervScout para placa neutra "I", 1,2 m
80-065-02-04*	NervScout-Neutralelektroden-Verbindungskabel "M", 1,2 m	NervScout neutral electrode connecting cable, "M", 1.2 m	Cable de conexión NervScout para placa neutra "M", 1,2 m
80-294-44-04	Anschlusskabel für Einmal-Neutralelektroden	Connecting cable for disposable neutral electrodes	Cable de conexión para placas neutras de un solo uso
80-344-09-04	Einmal-Neutralelektroden	Disposable neutral electrodes	Placas neutras desechables
80-811-50-04	Einpedal-Fußschalter	Single-pedal foot switch	Interruptor de pie monopedal
08-474-00-10	Montage-Set zur Kombination mit einem maxium®	Mounting set for combination with maxium®	Juego de montaje para la combinación con un maxium®

\* Zur Verbindung des Nervstimulators mit einem KLS-Martin-HF-Generator (im Kombinationsbetrieb)

\* To connect the nerve stimulator with a KLS Martin HF generator (when used in combination)

\* para la conexión del estimulador de nervios con un generador de AF de KLS Martin (en funcionamiento combinado)

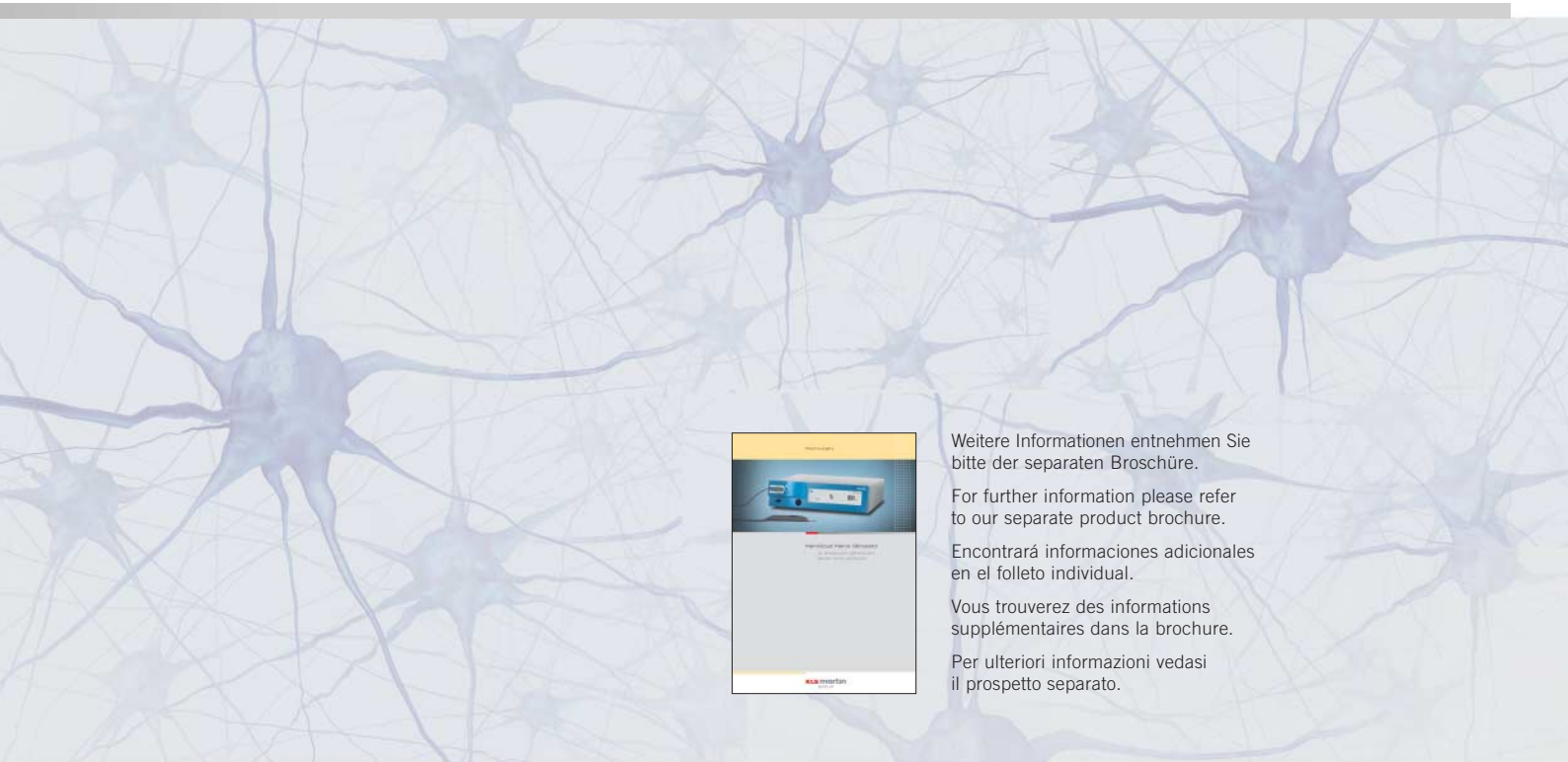

Weitere Informationen entnehmen Sie bitte der separaten Broschüre.

For further information please refer to our separate product brochure.

Encontrará informaciones adicionales en el folleto individual.

Vous trouverez des informations supplémentaires dans la brochure.

Per ulteriori informazioni vedasi il prospetto separato.

Le neurostimulateur NervScout permet de faire la différence entre les nerfs et les muscles durant l'intervention chirurgicale dans des structures tissulaires neuro-musculaires stimulables électriquement.

- Risque de blessure réduit
- Optimisation du résultat de l'intervention

Le neurostimulateur peut être utilisé **seul** ou en association avec un appareil électrochirurgical, par ex. pour **tester le fonctionnement du sphincter**.

Il neurostimolatore viene usato per la differenziazione intraoperatoria di nervi e muscoli in strutture di tessuto neuro-muscolari elettrostimolabili.

- Riduzione del rischio di lesioni
- Ottimizzazione del risultato operatorio

L'apparecchio può essere utilizzato come **neurostimolatore a sé stante** oppure in combinazione con un apparecchio elettrochirurgico ad alta frequenza, quale p. es. un **tester per lo sfintere**.

	Données de commande	Dati di ordinazione
80-065-00-04	NervScout	NervScout
80-217-01-04	Manche porte-électrode à 1 touche, câble de 4 m	Impugnatura per elettrodi con 1 tasto, cavo da 4 m
80-217-03-04	Manche NeuroPen à 3 touches, câble de 4 m	Impugnatura NeuroPen con 3 tasti, cavo da 4 m
80-220-00-04	Manche porte-électrode sans touche, câble de 4 m	Impugnatura per elettrodi senza tasto, cavo da 4 m
80-565-01-04	Électrode de stimulation (argentée), Ø 1 mm	Elettrodo per stimolazione (argentato), Ø 1 mm
80-565-02-04	Électrode de stimulation (argentée), Ø 2 mm	Elettrodo per stimolazione (argentato), Ø 2 mm
80-565-03-04	Électrode de stimulation (argentée), Ø 3 mm	Elettrodo per stimolazione (argentato), Ø 3 mm
80-181-51-04*	Câble de raccordement MABS, 1,2 m	Cavo di collegamento MABS, 1,2 m
80-065-01-04*	Câble de raccordement NervScout « I » pour électrode neutre, 1,2 m	Cavo di collegamento NervScout "I" per elettrodo neutro, 1,2 m
80-065-02-04*	Câble de raccordement NervScout « M » pour électrode neutre, 1,2 m	Cavo di collegamento NervScout "M" per elettrodo neutro, 1,2 m
80-294-44-04	Câble d'alimentation pour électrodes neutres jetables	Cavo di collegamento per elettrodi neutri monouso
80-344-09-04	Électrodes neutres jetables	Elettrodi neutri monouso
80-811-50-04	Interrupteur à simple pédale	Interruttore monopedale
08-474-00-10	Accessoires de montage visant la combinaison avec un appareil électrochirurgical maxium®	Set di montaggio per combinazione con maxium®

\* Pour relier le neurostimulateur et un générateur HF de KLS Martin (en mode combinaison)

\* Per il collegamento del neurostimolatore con un generatore AF di KLS Martin (con modalità di funzionamento combinato)







ÜBERSICHT DER ELEKTROCHIRURGISCHEN GERÄTE  
 OVERVIEW OF ELECTROSURGICAL UNITS  
 RESUMEN DE APARATOS ELECTROQUIRURGICOS  
 RESUME DES BISTOURIS ELECTROCHIRURGICAUX  
 ELENCO DEGLI APPARECCHI ELETTROCHIRURGICI

135-  
140

## maxium®



80-042-00-04  
 maxium® m

80-042-02-04  
 maxium® i

80-042-04-04  
 maxium® e

80-093-00-04  
 maxium®

Option bipolare Resektion  
 Bipolar Resection option  
 Opción Resección bipolar  
 Option Résection bipolaire  
 Opzione Resezione bipolare

80-093-01-04  
 maxium®

Option Einbindung in OR 1-Neo/Karl Storz  
 Option Integration into Karl Storz OR1 NEO system  
 Opción de integración en el sistema OR1 NEO/Karl Storz  
 Option Intégration dans le système OR1 NEO/Karl Storz  
 Opzione Integrazione nel sistema OR1 NEO/Karl Storz

80-093-02-04  
 maxium®

Option Einbindung in CORE nova®/Richard Wolf  
 Option Integration into CORE nova®/Richard Wolf system  
 Opción de integración en el sistema CORE nova®/Richard Wolf  
 Option Intégration dans le système CORE nova®/Richard Wolf  
 Opzione Integrazione nel sistema CORE nova®/Richard Wolf



80-044-00-04  
 maxium® Beamer

Nur zur Verwendung mit dem maxium®-Generator  
 For use only with the maxium® generator  
 Utilícese sólo con generador maxium®  
 A n'utiliser qu'avec générateur maxium®  
 Solo per l'utilizzo con generatore maxium®



80-081-00-04  
 Argon-Beamer MB 181



80-041-01-04  
ME 411



80-040-11-04  
ME MB 3 **m**

80-040-12-04  
ME MB 3 **i**



80-040-08-04  
ME MB 1  
mit Endo-Mode  
with Endo-Mode  
con Endo-Mode  
avec Endo-Mode  
con Endo-Mode



80-010-02-04  
ME 102



80-008-03-04  
Minicutter



80-006-02-04  
MD 62

Bitte bei Bestellung die Länderspannung beachten

Please indicate local supply voltage when placing your order

Por favor tome en cuenta el voltaje de su país al pedir el producto

Veuillez tenir compte de la tension en vigueur dans le pays lors de votre commande

Al momento dell'ordinazione controllare la tensione in uso nel paese di destinazione

# marTest



80-105-00-04

Prüfgerät marTest bestehend aus:

- Prüfgerät marTest
- Netzteil
- Leitungssatz zur Isolationsprüfung für MIC-Instrumente mit 4-mm-Anschluss
- Koffer zur Aufbewahrung

marTest tester comprised of:

- marTest tester
- Power supply unit
- Cable set for insulation testing on MIS instruments with 4 mm socket
- Storage case

Comprobador marTest compuesto por:

- Comprobador marTest
- Fuente de alimentación
- Juego de cables para la comprobación del aislamiento para instrumentos CMI con conexión de 4 mm
- Maletín (para guardar el aparato)

### Optionales Zubehör

Optional accessories  
 Accesorios opcionales  
 Accessoires en option  
 Accessori opzionali

80-105-01-04

Adapter zur Isolationsprüfung für bipolare Instrumente mit europäischem Flachpin-Stecker

Adapter for insulation testing on bipolar instruments with European flat-pin connector

Adaptador para la comprobación del aislamiento para instrumentos bipolares con clavija de pin plano europea

Adaptateur pour vérification de l'isolation des instruments bipolaires avec connecteur pin plat européen

Adattatore per prova di isolamento di strumenti bipolari con connettore a spina piatta europea

Dispositif testeur marTest, comprenant

- Appareil testeur marTest
- Bloc d'alimentation
- Lot de câbles pour vérification de l'isolation des instruments de chirurgie mini-invasive, avec connecteur de 4-mm
- Mallette de rangement

Apparecchio di prova marTest composto da:

- Apparecchio di prova marTest
- Alimentatore
- Set di cavi per prova di isolamento di strumenti per chirurgia mininvasiva con presa di 4 mm
- Valigetta per conservazione

80-105-02-04

Adapter zur Prüfung bipolares Resektoskopkabel Karl Storz (Art.-Nr. 80-287-96-04)

Adapter for testing bipolar resectoscope cables Karl Storz (item no. 80-287-96-04)

Adaptador para la comprobación del cable de resectoscopio bipolar Karl Storz (n.º art. 80-287-96-04)

Adaptateur pour contrôle du câble pour résectoscopes bipolaires Karl Storz (réf. 80-287-96-04)

Adattatore per la prova del cavo di resettoscopio bipolare Karl Storz (Codice 80-287-96-04)

SealSafe®



## DEVICE

## INSTRUMENT



Ø 2,4 mm

Ø 4,0 mm

### Electrode handles



### Monopolar

- KLS Martin
- Erbe
- Internat. 3-Pin
- Bovie

### Bipolar

- KLS Martin
- Erbe
- Internat. 2-Pin

### Neutral

- KLS Martin
- Erbe
- US-NE

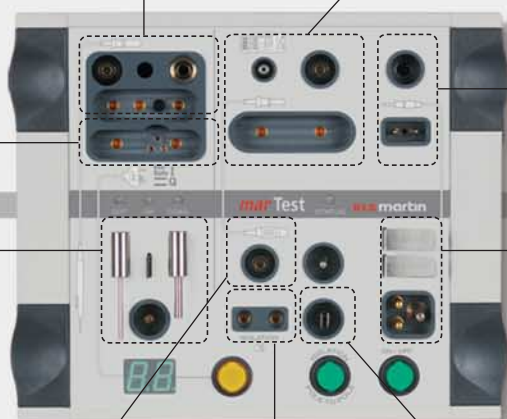

DEVICE

INSTRUMENT



Monopolar cables



Isolation



Bipolar cables



NE



80-103-00-04

EPM 4

Leistungsmesskoffer mit Software  
Portable power meter, with software  
Maleta para medir la potencia con software  
Coffre pour mesurer la puissance avec software  
Cofano per misurare la potenza con software

08-022-00-19

Bipolarer Prüfadapter: (7+1) für ME 401/411  
Bipolar test adapter: (7+1) for ME 401/411  
Adaptador de ensayo bipolar: (7+1) para ME 401/411  
Adaptateur de contrôle bipolaire: (7+1) pour ME 401/411  
Adattatore di prova bipolare (7+1) per ME 401/411

**Messkabel für EPM 4**  
**Test cable for EPM 4**  
**Cable de medición para EPM 4**  
**Câble de mesure pour EPM 4**  
**Cavo di misurazione per EPM 4**

08-022-00-21

Bipolarer Prüfadapter maxium® (ab HW 02)  
Bipolar test adapter for maxium® (from HW 02)  
Adaptador de control bipolar para maxium® (a partir del HW 02)  
Adaptateur de test bipolaire maxium® (à partir de HW 02)  
Adattatore di controllo bipolare maxium® (a partire da HW 02)

08-008-00-06

Messkabel Neutralelektrode KLS Martin  
Test cable for KLS Martin neutral electrode  
Cable de medición para placa neutra de KLS Martin  
Câble de mesure pour électrode neutre KLS Martin  
Cavo di misurazione per elettrodo neutro KLS Martin

08-008-00-08

Messkabel monopolar, KLS Martin  
Test cable, monopolar, KLS Martin  
Cable de medición monopolar, KLS Martin  
Câble de mesure monopolaire, KLS Martin  
Cavo di misurazione monopolare, KLS Martin

08-008-00-05

Messkabel Fußschalter bipolar  
Test cable for bipolar foot switch  
Cable de medición para interruptor de pie bipolar  
Câble de mesure pour interrupteur à pédale bipolaire  
Cavo di misurazione per interruttore a pedale bipolare

08-008-00-03

Messkabel Fußschalter monopolar für Kleingeräte  
Test cable for monopolar foot switch for minor HF units  
Cable de medición para interruptor de pie monopolar para equipos de AF pequeños  
Câble de mesure pour interrupteur à pédale monopolaire pour petits appareils  
Cavo di misurazione per interruttore a pedale monopolare per piccoli apparecchi AF

08-008-00-04

Messkabel Fußschalter monopolar für Großgeräte  
Test cable for monopolar foot switch for major HF units  
Cable de medición para interruptor de pie monopolar para equipos de AF grandes  
Câble de mesure pour interrupteur à pédale monopolaire pour grands appareils  
Cavo di misurazione per interruttore a pedale monopolare per grandi apparecchi AF

08-008-00-14

Messkabel bipolar KLS Martin / symmetrisch  
Test cable, bipolar, KLS Martin / symmetrical  
Cable de medición bipolar KLS Martin / simétrico  
Câble de mesure bipolaire KLS Martin / symétrique  
Cavo di misurazione bipolare KLS Martin / simmetrico



FUSSSCHALTER  
FOOT SWITCHES  
INTERRUPTORES DE PIE  
INTERRUPTEURS A PEDALE  
INTERRUTTORI A PEDALE

141-150

Fußschalter für Kleingeräte  
 Foot switches for minor electrosurgical units  
 Interruptores de pie para aparatos pequeños  
 Interrupteurs à pédale pour petits appareils  
 Interruttori a pedale per apparecchi piccoli



80-811-50-04

Monopolarer und bipolarer Fußschalter, explosionsgeschützt, AP-geprüft, IP X8, eintauchbar

Monopolar and bipolar foot switch, anti-explosive, AP-tested (anesthetics-proof), IP X8, immersible

Interruptor de pie monopolar y bipolar, antiexplosivo, controlada su aptitud para anestésicos, IP X8, sumergible

Interrupteur à pédale monopolaire et bipolaire, anti-explosif, catégorie AP, IP X8, immergeable

Interruttore a pedale monopolare e bipolare, anti-deflagrante, testato AP, IP X8, immergibile

**ME 81 (nur bipolar, bipolar only, sólo bipolar, bipolaire uniquement, solo bipolare)**

**ME K1**

**ME K2**

**ME 82**

**Mimicutter**

**ME 102 (nur bipolar, bipolar only, sólo bipolar, bipolaire uniquement, solo bipolare)**



80-812-10-04

Einpedal-Fußschalter, pneumatisch, 2 m Luftschlauch

Single-pedal foot switch, pneumatic, 2-m air hose

Interruptor de pie de un pedal, neumático, manguera de 2 m

Interrupteur à une pédale, pneumatique, tuyau à air de 2 m

Interruttore monopedale, pneumatico, con tubo flessibile per l'aria da 2 m

**MD 62**



80-811-04-04

Bipolarer Fußschalter, explosionsgeschützt, AP-geprüft, IP X8, eintauchbar

Bipolar foot switch, anti-explosive, AP-tested (anesthetics-proof), IP X8, immersible

Interruptor de pie, bipolar, antiexplosivo, controlada su aptitud para anestésicos, IP X8, sumergible

Interrupteur à pédale, bipolaire, anti-explosif, catégorie AP, IP X8, immergeable

Interruttore a pedale, bipolare, anti-deflagrante, testato AP, IP X8, immergibile

**ME 81 (nur bipolar, bipolar only, sólo bipolar, bipolaire uniquement, solo bipolare)**

**ME 82**

**Mimicutter (nur bipolar, bipolar only, sólo bipolar, bipolaire uniquement, solo bipolare)**

**ME 102 (nur bipolar, bipolar only, sólo bipolar, bipolaire uniquement, solo bipolare)**

Für alle Fußschalter gilt die Kabellänge 5 m (Ausnahme 80-812-10-04)

Cable length for all foot switches: 5 m (exception 80-812-10-04)

Todos los interruptores de pedal usan un cable de 5 m de longitud (excepción 80-812-10-04)

La longueur de câble de 5 m est valable pour tous les interrupteurs à pédale (exception 80-812-10-04)

Il cavo lungo 5 m è indicato per tutti gli interruttori a pedale (eccezione 80-812-10-04)



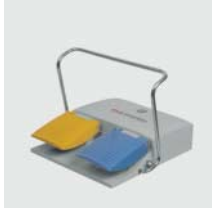

80-824-01-04

Doppelpedal-Fußschalter, monopolar, explosionsgeschützt, AP-geprüft, IP X8, eintauchbar

Double-pedal foot switch, monopolar, explosion- and anesthetics-proof (AP-tested), IP X8, immersible

Interruptor de pie de doble pedal, monopolar, antiexplosivo, controlada su aptitud para anestésicos, IP X8, sumergible

Interrupteur à pédale double, monopolaire, anti-explosif, catégorie AP, IP X8, immergeable

Interruttore a pedale doppio, monopolare, anti-deflagrante, testato AP, IP X8, immergibile

**ME 81**  
**ME 82**  
**ME 102**



80-823-02-04

Doppelpedal-Fußschalter, monopolar, kein AP-Schutz, nicht für OP-Bereich geeignet

Double-pedal foot switch, monopolar, not anesthetics-proof (AP), not suitable for use in operating area

Interruptor de pie de doble pedal, monopolar, no apto para anestésicos, inapropiado para el ámbito del quirófano

Interrupteur à pédale double, monopolaire, pas résistant aux produits anesthésiques, ne convient pas pour une utilisation en salle d'opération

Interruttore a pedale doppio, monopolare, senza protezione AP, non adatto all'uso in sala operatoria

**ME 81**  
**ME 102**

**NON-CE**



80-811-10-04

Monopolarer und bipolarer Fußschalter, kein AP-Schutz, nicht für OP-Bereich geeignet

Monopolar and bipolar foot switch, not anesthetics-proof (AP), not suitable for use in operating area

Interruptor de pie monopolar y bipolar, no apto para anestésicos in apropiado para el ámbito del quirófano

Interrupteur à pédale monopolaire et bipolaire, pas résistant aux produits anesthésiques, ne convient pas pour une utilisation en salle d'opération

Interruttore a pedale monopolare e bipolare, senza protezione AP, non adatto all'uso in sala operatoria

**ME 81 (nur bipolar, bipolar only, sólo bipolar, bipolaire uniquement, solo bipolare)**  
**ME K1**  
**ME K2**  
**ME 82**  
**Minicutter**  
**ME 102 (nur bipolar, bipolar only, sólo bipolar, bipolaire uniquement, solo bipolare)**

Für alle Fußschalter gilt die Kabellänge 5 m

Cable length for all foot switches: 5 m

Todos los interruptores de pedal usan un cable de 5 m de longitud

La longueur de câble de 5 m est valable pour tous les interrupteurs à pédale

Il cavo lungo 5 m è indicato per tutti gli interruttori a pedale

Fußschalter für Großgeräte  
Foot switch for major electrosurgical units  
Interruptor de pedal para gran aparatos  
Interrupteur à pédale pour grands appareils  
Interruttore a pedale per apparecchi grandi



80-821-02-04

Doppelpedal-Fußschalter, explosionsgeschützt, AP-geprüft, IP X8, eintauchbar

Double-pedal foot switch, explosion- and anesthetics-proof (AP-tested), IP X8, immersible

Interruptor de pie de doble pedal, antiexplosivo, controlada su aptitud para anestésicos, IP X8, sumergible

Interrupteur à pédale double, anti-explosif, catégorie AP, IP X8, immergeable

Interruttore a pedale doppio, anti-deflagrante, testato AP, IP X8, immergibile

*ME 400/200 (nur monopolar, monopolar only, sólo monopolar, monopolaire uniquement, solo monopolare)*

*ME 401/411 (nur monopolar, monopolar only, sólo monopolar, monopolaire uniquement, solo monopolare)*

*ME M1/ME MB 1*

*ME CDI*

*ME MB 3*

*ME MB 2*

**maxium®**



80-821-03-04

maxium®-SWAP-Mode-Doppelpedal-Fußschalter, explosionsgeschützt, AP-geprüft, IP X8, eintauchbar

maxium® double-pedal foot switch with SWAP mode, explosion-protected, AP-tested (anesthetics-proof), IP X8, immersible

Interruptor de pie de doble pedal maxium® con modo SWAP, protegido contra explosiones, controlada su aptitud para anestésicos, IP X8, sumergible

Interrupteur à double pédale maxium® avec mode SWAP, protégé contre les explosions, testé pour anesthésiants, IP X8, immergeable

Interruttore a doppio pedale maxium® con modalità SWAP, con protezione antiesplosione, a prova di anestetici, IP X8, immergibile

**maxium®**

*maxium® ab HW 06, Software V3.398*

*maxium® from HW06 and software V3.398*

*maxium® a partir del HW06 y software V3.398*

*maxium® à partir de la version matérielle 06, version logicielle V3.398*

*maxium® versione HW06 o superiore e software V3.398 o superiore*

Für alle Fußschalter gilt die Kabellänge 5 m

Cable length for all foot switches: 5 m

Todos los interruptores de pedal usan un cable de 5 m de longitud

La longueur de câble de 5 m est valable pour tous les interrupteurs à pédale

Il cavo lungo 5 m è indicato per tutti gli interruttori a pedale

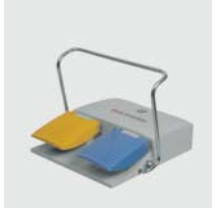

80-821-05-04

Doppelpedal-Fußschalter, explosionsgeschützt, AP-geprüft, IP X8, eintauchbar  
Double-pedal foot switch, explosion- and anesthetics-proof (AP-tested), IP X8, immersible  
Interruptor de pie de doble pedal, antiexplosivo, controlada su aptitud para anestésicos, IP X8, sumergible  
Interrupteur à pédale double, anti-explosif, catégorie AP, IP X8, immergeable  
Interruttore a pedale doppio, anti-deflagrante, testato AP, IP X8, immergibile

*ME 400/200 (nur monopolar, monopolar only, sólo monopolar, monopolaire uniquement, solo monopolare)*  
*ME 401/411 (nur monopolar, monopolar only, sólo monopolar, monopolaire uniquement, solo monopolare)*  
**ME M1/ME MB 1**  
**ME CD1**  
**ME MB 3**  
**ME MB 2**  
**maxium®**



80-811-30-04

Doppelpedal-Fußschalter, explosionsgeschützt, AP-geprüft, IP X8, eintauchbar  
Double-pedal foot switch, explosion- and anesthetics-proof (AP-tested), IP X8, immersible  
Interruptor de pie de doble pedal, antiexplosivo, controlada su aptitud para anestésicos, IP X8, sumergible  
Interrupteur à pédale double, anti-explosif, catégorie AP, IP X8, immergeable  
Interruttore a pedale doppio, anti-deflagrante, testato AP, IP X8, immergibile

*ME 400/200 (nur monopolar, monopolar only, sólo monopolar, monopolaire uniquement, solo monopolare)*  
*ME 401/411 (nur monopolar, monopolar only, sólo monopolar, monopolaire uniquement, solo monopolare)*  
**ME M1/ME MB 1**  
**ME CD1**  
**ME MB 3**  
**ME MB 2**  
**maxium®**



80-811-32-04

maxium®-SWAP-Mode-Doppelpedal-Fußschalter Eco, AP-geprüft, IP X8, eintauchbar  
maxium® double-pedal foot switch with SWAP mode Eco, AP-tested (anesthetics-proof), IP X8, immersible  
Interruptor de pie de doble pedal maxium® con modo SWAP Eco, controlada su aptitud para anestésicos, IP X8, sumergible  
Interrupteur à double pédale maxium® avec mode SWAP Eco, testé pour anesthésiants, IP X8, immergeable  
Interruttore a doppio pedale maxium® con modalità SWAP Eco, a prova di anestetici, IP X8, immergibile

**maxium®**

**maxium® ab HW 06, Software V3.398**  
**maxium® from HW06 and software V3.398**  
**maxium® a partir del HW06 y software V3.398**  
**maxium® à partir de la version matérielle 06, version logicielle V3.398**  
**maxium® versione HW06 o superiore e software V3.398 o superiore**

Für alle Fußschalter gilt die Kabellänge 5 m  
Cable length for all foot switches: 5 m  
Todos los interruptores de pedal usan un cable de 5 m de longitud  
La longueur de câble de 5 m est valable pour tous les interrupteurs à pédale  
Il cavo lungo 5 m è indicato per tutti gli interruttori a pedale



80-811-04-04

Fußschalter, explosionsgeschützt, AP-geprüft, IP X8, eintauchbar

Foot switch, explosion- and anesthetics-proof (AP-tested), IP X8, immersible

Interruptor de pie, antiexplosivo, controlada su aptitud para anestésicos, IP X8, eintauchbar

Interrupteur à pédale, anti-explosif, catégorie AP, IP X8, immergeable

Interruttore a pedale, anti-deflagrante, testato AP, IP X8, immergibile

**ME 200/400 (nur bipolar, bipolar only, sólo bipolar, bipolaire uniquement, solo bipolare)**

**ME 401/411 (nur bipolar, bipolar only, sólo bipolar, bipolaire uniquement, solo bipolare)**

**maxium®**



80-821-04-04

Bipolarer Doppelpedal-Fußschalter, explosionsgeschützt, AP-geprüft, IP X8, immersible

Bipolar double-pedal switch, explosion- and anesthetics-proof (AP-tested), IP X8, eintauchbar

Interruptor de pedal doble, bipolar, antiexplosivo, controlada su aptitud para anestésicos, IP X8, sumergible

Interrupteur à pédale double, bipolaire, anti-explosif, catégorie AP, IP X8, immergeable

Interruttore a doppio pedale, anti-deflagrante, testato AP, IP X8, immergibile

**ME 401/411**



80-811-50-04

Fußschalter, explosionsgeschützt, AP-geprüft, IP X8, immersible

Foot switch, explosion- and anesthetics-proof (AP-tested), IP X8, eintauchbar

Interruptor de pie, antiexplosivo, controlada su aptitud para anestésicos, IP X8, sumergible

Interrupteur à pédale, anti-explosif, catégorie AP, IP X8, immergeable

Interruttore a pedale, anti-deflagrante, testato AP, IP X8, immergibile

**ME 200/400 (nur bipolar, bipolar only, sólo bipolar, bipolaire uniquement, solo bipolare)**

**ME 401/411 (nur bipolar, bipolar only, sólo bipolar, bipolaire uniquement, solo bipolare)**

**maxium®**

Für alle Fußschalter gilt die Kabellänge 5 m

Cable length for all foot switches: 5 m

Todos los interruptores de pedal usan un cable de 5 m de longitud

La longueur de câble de 5 m est valable pour tous les interrupteurs à pédale

Il cavo lungo 5 m è indicato per tutti gli interruttori a pedale

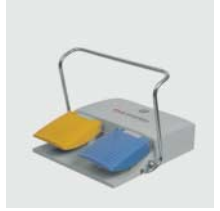

80-825-30-04

Bipolarer Doppelpedal-Fußschalter, explosionsgeschützt, AP-geprüft, IP X8, eintauchbar

Bipolar double-pedal switch, explosion- and anesthetics-proof (AP-tested), IP X8, immersible

Interruptor de pedal doble, bipolar, antiexplosivo, controlada su aptitud para anestésicos, IP X8, sumergible

Interrupteur à pédale double, bipolaire, anti-explosif, catégorie AP, IP X8, immergeable

Interruttore a doppio pedale, anti-deflagrante, testato AP, IP X8, immergibile

ME 401/411



80-797-00-04

Adapter mit gewinkeltem Stecker

Adapter with angled connector

Adaptador con clavija acodada

Adaptateur avec connecteur coudé

Adattatore con connettore angolato

*für Fußschalter  
for foot switch  
para interruptor de pedal  
pour interrupteur à pédale  
per interruttore a pedale*

80-821-02-04

80-821-03-04

80-811-30-04

80-811-32-04

80-821-05-04

1/3



80-797-01-04

Adapter mit gewinkeltem Stecker

Adapter with angled connector

Adaptador con clavija acodada

Adaptateur avec connecteur coudé

Adattatore con connettore angolato

*für Fußschalter  
for foot switch  
para interruptor de pedal  
pour interrupteur à pédale  
per interruttore a pedale*

80-811-04-04

80-811-50-04

1/3







Für alle Fußschalter gilt die Kabellänge 5 m

Cable length for all foot switches: 5 m







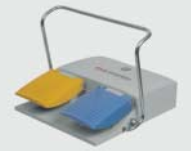

Todos los interruptores de pedal usan un cable de 5 m de longitud

La longueur de câble de 5 m est valable pour tous les interrupteurs à pédale

Il cavo lungo 5 m è indicato per tutti gli interruttori a pedale

Fußschalter Foot switches Interruptores de pie Interrupteurs à pédale Interruttori a pedale	KLS Martin Kleingeräte / Low-end units / Equipos de gama baja / Petits appareils / Apparecchi di piccole dimensioni						
	ME 81	ME 82	Minicutter	ME 102	ME K1	ME K2	MD 62
80-811-10-04 	X nur bipolar, bipolar only, sólo bipolar, bipolaire uniquement, solo bipolare	X	X	X nur bipolar, bipolar only, sólo bipolar, bipolaire uniquement, solo bipolare	X	X	
80-811-50-04 	X nur bipolar, bipolar only, sólo bipolar, bipolaire uniquement, solo bipolare	X	X	X nur bipolar, bipolar only, sólo bipolar, bipolaire uniquement, solo bipolare	X	X	
80-811-04-04 	X nur bipolar, bipolar only, sólo bipolar, bipolaire uniquement, solo bipolare	X	X	X nur bipolar, bipolar only, sólo bipolar, bipolaire uniquement, solo bipolare			
80-824-01-04 	X nur monopolar, monopolar only, sólo monopolar, monopolaire uniquement, solo monopolare	X nur monopolar, monopolar only, sólo monopolar, monopolaire uniquement, solo monopolare		X			
80-812-10-04 							X
80-823-02-04  NON-CE	X nur monopolar, monopolar only, sólo monopolar, monopolaire uniquement, solo monopolare			X			



Fußschalter Foot switches Interruptores de pie Interrupteurs à pédale Interruttori a pedale	KLS Martin Großgeräte / High-end units / Equipos de gama alta / Grands appareils / Apparecchi di grandi dimension									
	maXium®	ME 411	ME 401	ME 400	ME 200	ME MB 1	ME M1	ME CD1	ME MB 2	ME MB 3
80-821-02-04 	X	X nur monopolar, monopolar only, sólo monopolar, monopolaire uniquement, solo monopolare	X nur monopolar, monopolar only, sólo monopolar, monopolaire uniquement, solo monopolare	X nur monopolar, monopolar only, sólo monopolar, monopolaire uniquement, solo monopolare	X nur monopolar, monopolar only, sólo monopolar, monopolaire uniquement, solo monopolare	X	X	X	X	X
80-821-03-04 	X nur only sólo uniquement solo HW. 06, SW V3.398									
80-811-32-04 	X nur only sólo uniquement solo HW. 06, SW V3.398									
80-821-05-04 	X	X nur monopolar, monopolar only, sólo monopolar, monopolaire uniquement, solo monopolare	X nur monopolar, monopolar only, sólo monopolar, monopolaire uniquement, solo monopolare	X nur monopolar, monopolar only, sólo monopolar, monopolaire uniquement, solo monopolare	X nur monopolar, monopolar only, sólo monopolar, monopolaire uniquement, solo monopolare	X	X	X	X	X
80-821-04-04 		X nur bipolar, bipolar only, sólo bipolar, bipolaire uniquement, solo bipolare	X							
80-811-30-04 	X	X nur monopolar, monopolar only, sólo monopolar, monopolaire uniquement, solo monopolare	X nur monopolar, monopolar only, sólo monopolar, monopolaire uniquement, solo monopolare	X nur monopolar, monopolar only, sólo monopolar, monopolaire uniquement, solo monopolare	X nur monopolar, monopolar only, sólo monopolar, monopolaire uniquement, solo monopolare	X	X	X	X	X
80-825-30-04 		X nur bipolar, bipolar only, sólo bipolar, bipolaire uniquement, solo bipolare	X							
80-811-04-04 	X	X nur bipolar, bipolar only, sólo bipolar, bipolaire uniquement, solo bipolare	X nur bipolar, bipolar only, sólo bipolar, bipolaire uniquement, solo bipolare	X nur bipolar, bipolar only, sólo bipolar, bipolaire uniquement, solo bipolare	X nur bipolar, bipolar only, sólo bipolar, bipolaire uniquement, solo bipolare					
80-811-50-04 	X	X nur bipolar, bipolar only, sólo bipolar, bipolaire uniquement, solo bipolare	X nur bipolar, bipolar only, sólo bipolar, bipolaire uniquement, solo bipolare	X nur bipolar, bipolar only, sólo bipolar, bipolaire uniquement, solo bipolare	X nur bipolar, bipolar only, sólo bipolar, bipolaire uniquement, solo bipolare					







NETZKABEL  
MAINS CABLES  
CABLES DE CONEXIÓN A LA RED  
CÂBLES D'ALIMENTATION RESEAU  
CAVI D'ALIMENTAZIONE DALLA RETE

151-152

Für alle KLS-Martin-HF-Geräte und KLS-Martin-Argon-Beamer: Kabellänge 3 m  
 Cable length for all KLS Martin HF units and KLS Martin Argon Beamer: 3 m  
 Todos los aparatos de AF KLS Martin y el KLS Martin Argon Beamer necesitan un cable de 3 m  
 Pour tous les appareils HF KLS Martin et le Diffuseur d'Argon KLS Martin: longueur de câble 3 m  
 Per tutti gli apparecchi AF KLS Martin e per il KLS Martin Argon Beamer: lunghezza cavo 3 m



1/3

08-024-00-23

Netzkabel, z.B. für Deutschland, Frankreich, Österreich, Skandinavien

Mains cables, for ex. for Germany, France, Austria, Scandinavia

Cables de conexión a la red, p. ej. para Alemania, Francia, Austria, Escandinavia

Câbles d'alimentation réseau, par ex. pour l'Allemagne, France, Autriche, Scandinavie

Cavi d'alimentazione, p. es. per la Germania, Francia, Austria, Scandinavia



1/3

08-024-00-28

Netzkabel für die Schweiz

Mains cables for Switzerland

Cables de conexión a la red para Suiza

Câbles d'alimentation réseau pour la Suisse

Cavi d'alimentazione per la Svizzera



1/3

08-024-00-29

Netzkabel, z.B. für Taiwan, Korea, USA, Kanada

Mains cables, for ex. for Taiwan, Korea, USA, Canada

Cables de conexión a la red, p. ej. para Taiwan, Corea, USA, Canadá

Câbles d'alimentation réseau, par ex. pour Taiwan, la Corée, USA, Canada

Cavi d'alimentazione, p. es. per Taiwan, Corea, USA, Canada



1/3

08-024-00-30

Netzkabel für Italien

Mains cables for Italy

Cables de conexión a la red para Italia

Câbles d'alimentation réseau pour l'Italie

Cavi d'alimentazione per Italia



1/3

08-024-00-31

Netzkabel für Japan

Mains cables for Japan

Cables de conexión a la red para Japón

Câbles d'alimentation réseau pour Japon

Cavi d'alimentazione per Giappone



1/3

08-024-00-40

Netzkabel für Grossbritannien, Irland, Vereinigte Arabische Emirate

Mains cables for United Kingdom, Ireland, United Arab Emirates

Cables de red para el Reino Unido, Irlanda, Emiratos Árabes Unidos.

Câbles d'alimentation réseau pour la Grande-Bretagne, l'Irlande, les Emirats Arabes Unis

Cavi di rete per Gran Bretagna, Irlanda, Emirati Arabi Uniti



1/3

08-024-00-41

Netzkabel für China

Mains cables for China

Cables de conexión a la red para China

Câbles d'alimentation réseau pour Chine

Cavi d'alimentazione per Cina



FAHRGESTELLE  
TROLLEYS  
SOPORTES MOVILES  
CHARIOTS  
CARRELLI

153-159



#### 80-047-00-04

maxium® Cart II – geeignet für alle KLS Martin Großgeräte

- Abmessungen (B x H x T): 658 x 862 x 582 mm
- 4 Doppelrollen mit 2 Bremsen
- Griff zum Schieben
- Ablagekorb und Ablageboden
- Aufnahme für Argon-Gasflaschen (5 Ltr.) in der Säule  
inkl. Halterung für zwei Gasflaschen
- 4 Potentialausgleichsanschlüsse (POAG)
- Netzeingang, Netzkabel 5 m
- Netzabgänge
- Gewicht 38,5 Kg

Inklusive folgendem Zubehör:

- Ablagekorb für Zubehör (1x)
- Normschiene (1x)
- Fußschalterhalterung (1x)

#### 80-047-00-04

maxium® Cart II – suitable for all major KLS Martin units

- Dimensions (W x H x D): 658 x 862 x 582 mm
- 4 dual castors with 2 brakes
- Push handle
- Storage basket and storage platform
- Receptacle for argon gas cylinders (5 l) inside column,  
incl. support for fixation of 2 gas cylinders
- 4 equipotential bonding connectors
- Mains input socket, 5-m mains cable
- Mains power outputs
- Weight 38.5 Kg

Includes the following accessories:

- Basket for storing accessories (1)
- Standard rail (1)
- Foot switch support (1)

#### 80-047-00-04

maxium® Cart II – adecuado para todos los aparatos de gran tamaño de KLS Martin

- Dimensiones (A x Al x P): 658 x 862 x 582 mm
- 4 ruedas dobles con 2 dispositivos de bloqueo
- Asidero para empujar
- Cesta de deposición y chapa de deposición
- Recepción para bombonas de gas argón (5 l) dentro de la columna, incl. soporte para la fijación de dos bombonas de gas
- 4 hembrillas de conexión equipotencial
- Hembrilla de entrada de red, cable de red de 5 m
- Salidas de red
- Peso 38,5 Kg

Incluye los siguientes accesorios:

- Cesta de deposición para accesorios (1x)
- Raíl normalizado (1x)
- Soporte para interruptor de pie (1x)

#### 80-047-00-04

maxium® Cart II – pour tous les grands appareils KLS Martin

- Dimensions (L x H x P): 658 x 862 x 582 mm
- 4 roulettes doubles avec 2 freins de blocage
- Poignée pour pousser
- Panier et plateau de rangement
- Réceptacle pour bouteilles d'argon (5 l) dans la colonne,  
support pour deux bouteilles de gaz incl.
- 4 raccords de compensation de potentiel
- Entrée de réseau, câble d'alimentation 5 m
- Sortie d'alimentation
- Poids 38,5 Kg

Y compris les accessoires suivants :

- Corbeille de rangement pour accessoires (1x)
- Raíl standard (1x)
- Support pour interrupteur à pédale (1x)

#### 80-047-00-04

maxium® Cart II – indicato per tutti i grandi apparecchi KLS Martin

- Dimensioni (L x A x P): 658 x 862 x 582 mm
- 4 rulli doppi con 2 freni
  - Impugnatura per spingere
  - Cestello portaoggetti e ripiano portaoggetti
  - Attacco per bombola di gas argon (5 l) in una colonna  
compreso supporto per due bombole di gas
  - 4 raccordi di bilanciamento potenziale
  - Ingresso rete, cavo di rete da 5 m
  - Uscite di rete
  - Peso 38,5 Kg

Compresi i seguenti accessori:

- Cestello portaoggetti per accessori (1x)
- Guida standard (1x)
- Supporto per interruttore a pedale (1x)



**Optionales Zubehör für maxium® Cart II (80-047-00-04)**

- Zusätzlicher Ablagekorb, Art. 08-169-00-20
- Nachrüstsatz Trenntransformator 1.200 VA, für maxium® Cart II, Art.-Nr. 80-047-01-04, mit elektronischer Einschaltstrombegrenzung

**Optional accessories for maxium® Cart II (80-047-00-04)**

- Additional storage basket, item no. 08-169-00-20
- Isolating transformer (retrofit kit), 1,200 VA, for maxium® Cart II, item no. 80-047-01-04, with electronic start-up current limitation

**Accesorios opcionales para el maxium® Cart II (80-047-00-04)**

- Cesta de deposición adicional, n.º ref. 08-169-00-20
- Juego de reequipamiento: transformador separador, 1.200 VA, para maxium® Cart II, n.º ref. 80-047-01-04, con limitación electrónica de la corriente de arranque

**Accessoires en option pour maxium® Cart II (80-047-00-04)**

- Panier de rangement supplémentaire, réf. 08-169-00-20
- Set d'équipement ultérieur : transformateur de séparation, 1.200 VA, pour maxium® Cart II, réf. 80-047-01-04, avec limitation électronique du courant de démarrage

**Accessori opzionali per maxium® Cart II (80-047-00-04)**

- Cestello portaoggetti supplementare, codice art. 08-169-00-20
- Set di riequipaggiamento: trasformatore di isolamento, 1.200 VA, per maxium® Cart II, codice art. 80-047-01-04, con limitazione elettronica della corrente di attivazione



80-260-50-04

4 m/13 ft.

Potentialausgleichskabel  
Potential equalization cable  
Cable de conexión equipotencial  
Câble de compensation de potentiel  
Cavo per collegamento equipotenziale

Die abgebildeten Geräte sind im Lieferumfang nicht enthalten!  
The HF units shown are not included in the scope of supply!  
¡Los equipos representados en las imágenes no forman parte del suministro!  
Les appareils présentés ici ne font pas partie de la livraison !  
Gli apparecchi raffigurati non fanno parte della fornitura!

maxium® Cart II mit verschiedenen Komponenten  
 maxium® Cart II with various components  
 maxium® Cart II con diferentes componentes  
 maxium® Cart II avec différents composants  
 maxium® Cart II con diversi componenti



**Frontansicht maxium® Cart II (Art.-Nr. 80-047-00-04)**  
**Front view of maxium® Cart II (item no. 80-047-00-04)**  
**Vista frontal del maxium® Cart II (n.º ref. 80-047-00-04)**  
**Vue de face de maxium® Cart II (réf. 80-047-00-04)**  
**Immagine frontale di maxium® Cart II (codice art. 80-047-00-04)**

- ① Gehäusebasis für zwei Argon-Gasflaschen  
 Housing base for storing two argon gas cylinders  
 Base de la carcasa para albergar dos bombonas de gas argón  
 Base du bâti pour deux bouteilles de gaz d'argon  
 Base dell'alloggiamento per la collocazione di due bombole di gas argon
- ② Lochraster für Höhenverstellung des Ablagekorbes  
 Grid of holes for height adjustment of the storage basket  
 Reticula de perforaciones para el ajuste en altura de la cesta de deposición  
 Perforation pour le réglage en hauteur du panier de rangement  
 Griglia perforata per lo spostamento in altezza del cestello portaoggetti
- ③ Ablagekorb  
 Storage basket  
 Cesta de deposición  
 Panier de rangement  
 Cestello portaoggetti
- ④ Doppellenk-Rolle mit Bremse (2 Stück)  
 Dual castor with brake (2 items)  
 Rodillo doble giratorio con freno (2 unidades)  
 Roulette double avec frein de blocage (2 pièces)  
 Rotelle orientabili doppie con freno (2 pezzi)
- ⑤ Halterung für Doppelpedalfußschalter Art. 80-821-02-04  
 Support for double-pedal foot switch no. 80-821-02-04  
 Soporte para el interruptor de pie de doble pedal, n.º ref. 80-821-02-04  
 Support pour interrupteur à pédale double (réf. 80-821-02-04)  
 Supporto per interruttore a doppio pedale (codice art. 80-821-02-04)

Die abgebildeten Geräte sind im Lieferumfang nicht enthalten!  
 The HF units shown are not included in the scope of supply!  
 ¡Los equipos representados en las imágenes no forman parte del suministro!  
 Les appareils présentés ici ne font pas partie de la livraison !  
 Gli apparecchi raffigurati non fanno parte della fornitura!

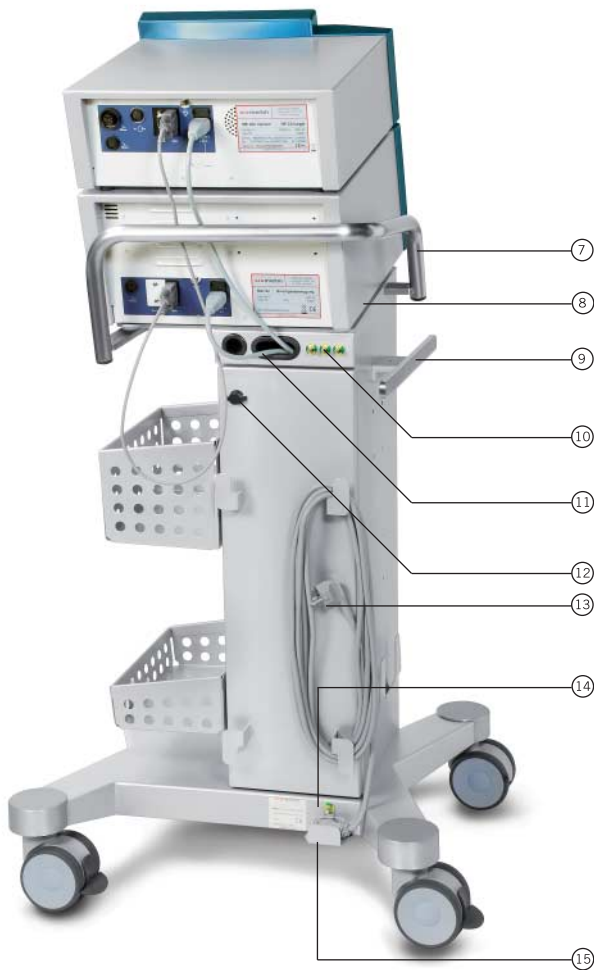

**Rückansicht maxium® Cart II (Art.-Nr. 80-047-00-04)**  
**Rear view of maxium® Cart II (item no. 80-047-00-04)**  
**Vista posterior del maxium® Cart II (n.º ref. 80-047-00-04)**  
**Vue de derrière de maxium® Cart II (réf. 80-047-00-04)**  
**Immagine posteriore di maxium® Cart II (codice art. 80-047-00-04)**

- ⑦ Umlaufender Haltegriff  
All-round handle  
Asidero continuo  
Poignée sur le pourtour  
Impugnatura continua di sostegno
- ⑧ Geneigter Ablageboden (15°)  
Inclined storage platform (15°)  
Chapa de deposición inclinada (15°)  
Plateforme inclinée (15°)  
Ripiano portaoggetti inclinato (15°)
- ⑨ Normschiene  
Standard rail  
Raíl normalizado  
Rail standard  
Guida standard
- ⑩ Drei POAG-Anschlussbuchsen  
3 equipotential bonding sockets  
Tres hembrillas de conexión equipotencial  
Trois prises de compensation de potentiel  
Tre prese per compensatore di potenziale
- ⑪ Drei Netzanschlusskabel  
3 mains connecting cables  
Tres cables de conexión de red  
Trois câbles de raccordement au secteur  
Tre cavi di alimentazione elettrica
- ⑫ Türe mit Schließfunktion  
Door with locking function  
Puerta con función de cierre  
Porte avec fonction de fermeture  
Porta con funzione di chiusura
- ⑬ Netzkabel, 5 m, z.B. für Deutschland, Frankreich, Österreich, Skandinavien  
Mains cables, 5 m, for ex. for Germany, France, Austria, Scandinavia  
Cables de conexión a la red, 5 m, p. ej. para Alemania, Francia, Austria, Escandinavia  
Câbles d'alimentation réseau, 5 m, par ex. pour l'Allemagne, France, Autriche, Scandinavie  
Cavi d'alimentazione, 5 m, p. es. per la Germania, Francia, Austria, Scandinavia
- ⑭ Zentrale POAG-Anschlussbuchse  
Central equipotential bonding socket  
Hembrilla de conexión equipotencial central  
Prise centrale de compensation de potentiel  
Presa centrale per compensatore di potenziale
- ⑮ Zentraler Netzeingang (gesichert)  
Central mains input socket (fused)  
Hembrilla de entrada de red central (protegida por fusible)  
Entrée centrale de secteur (protégée par fusibles)  
Ingresso centrale di rete (con fusibile)

Die abgebildeten Geräte sind im Lieferumfang nicht enthalten!  
 The HF units shown are not included in the scope of supply!  
 ¡Los equipos representados en las imágenes no forman parte del suministro!  
 Les appareils présentés ici ne font pas partie de la livraison!  
 Gli apparecchi raffigurati non fanno parte della fornitura!

HF-Fahrwagen  
 HF trolleys  
 Carros portaequipos de AF  
 Chariots HF  
 Carrelli AF



80-070-00-04

HF-Fahrwagen  
 HF trolley  
 Carro portaequipos de AF  
 Chariot HF  
 Carrello AF

**Optionales Zubehör für HF-Fahrwagen Art.-Nr. 80-070-00-04**  
**Optional accessories for HF trolley no. 80-070-00-04**  
**Accesorio opcional para el carro de AF, n.º ref. 80-070-00-04**  
**Accessoires en option pour chariot HF, réf. 80-070-00-04**  
**Accessori opzionali per carrello AF, codice art. 80-070-00-04**



80-070-01-04

Halterung für Argon-Gasflasche  
 Support for argon gas cylinder  
 Soporte para la sujeción de la bombona de gas argón  
 Support pour bouteille de gaz d'argon  
 Supporto per bombola di gas argon



08-025-00-23 = 5 m

Netzkabel, z.B. für Deutschland,  
 Frankreich, Österreich

Mains cables, for ex. for Germany,  
 France, Austria

Cables de conexión a la red, p. ej. para  
 Alemania, Francia, Austria

Câbles d'alimentation réseau, par ex.  
 pour l'Allemagne, France, Autriche

Cavi d'alimentazione, p. es. per la  
 Germania, Francia, Austria

08-156-00-11

Rolle, feststellbar, für HF-Fahrwagen (1 Stück)  
 Castor, lockable, for HF trolley (1 piece)  
 Rodillo, bloqueable, para carro de AF (1 pieza)  
 Roulette, blocable, pour chariot HF (1 pièce)  
 Rotella, bloccabile, per carrello AF (1 pezzo)

80-070-05-04

Rollensatz für HF-Fahrwagen 80-070-00-04  
 Ø 100 mm (2 Stück feststellbar, 2 Stück ungebremst)

Set of castors for HF trolley 80-070-00-04,  
 Ø 100 mm (2 lockable, 2 without brake)

Juego de ruedas para el carro portaequipos 80-070-00-04,  
 Ø 100 mm (2 unidades bloqueables, 2 unidades sin freno)

Lot de roulettes pour chariot HF 80-070-00-04  
 Ø 100 mm (2 roulettes blocables, 2 roulettes non freinées)

Set di rotelle per carrello AF 80-070-00-04, Ø 100 mm  
 (2 rotelle fissabili, 2 rotelle senza freno)





- Geeignet für alle KLS-Martin-HF-Großgeräte, z.B. ME MB 1/2/3, ME 411 oder **maxium®**
  - Farbe: Eloxal-Silber
  - Elektrisch leitfähige Doppelrollen (ESD) mit 65 mm Durchmesser
  - Ablagefach
  - Optionaler Drahtkorb zur Ablage von Zubehörkomponenten (08-168-00-20)
  - Kabelhalterung für das Netzkabel
  - Abmessungen: 400 x 430 x 900 mm (B x H x T)
- Suitable for all major KLS Martin HF units. e.g. ME MB 1/2/3, ME 411, **maxium®** etc.
  - Color: silver-anodized
  - Electrically conductive dual castors (ESD), diameter 65 mm
  - Storage compartment
  - Optional wire basket for storing accessories (08-168-00-20)
  - Power cord holder
  - Dimensions: 400 x 430 x 900 mm (W x H x D)
- Adequado para todos los equipos de AF KLS Martin de gran tamaño, p. ej. ME MB 1/2/3, ME 411 o **maxium®**
  - Color: anodizado plateado
  - Rodillos dobles electroconductores (DES) con 65 mm de diámetro
  - Cajón de deposición
  - Cesta de alambre opcional para la deposición de componentes accesorios (08-168-00-20)
  - Sujeción para el cable de red
  - Dimensiones: 400 x 430 x 900 mm (An x A x P)
- Pour tous les grands appareils HF KLS Martin, par ex. ME MB 1/2/3, ME 411 ou **maxium®**
  - Couleur: anodisation argentée
  - Roues doubles conductrices (ESD) de diamètre 65 mm
  - Compartiment de rangement
  - Panier métallique en option pour le rangement des accessoires (08-168-00-20)
  - Attache pour le câble de réseau
  - Dimensions: 400 x 430 x 900 mm (l x h x p)
- Adatto a tutti gli apparecchi grandi AF KLS Martin, p. es. ME MB 1/2/3, ME 411 o **maxium®**
  - Colore: anodizzazione argentea
  - Rotelle doppie (ESD) a conduzione elettrica con diametro di 65 mm
  - Compartimento
  - Optional cestino in metallo per poggiare accessori (08-168-00-20)
  - Supporto cavo per cavo di alimentazione
  - Dimensioni: 400 x 430 x 900 mm (L x A x P)

**Halterung für HF-Kleingeräte**  
**Support for minor HF units**  
**Soporte para equipos de AF pequeños**  
**Support pour petits appareils HF**  
**Supporto per piccoli apparecchi AF**

	<b>Befestigungssatz</b>	<b>Fastening kit</b>	<b>Juego de sujeción</b>	<b>Set d'accrochage</b>	<b>Set di fissaggio</b>
80-070-02-04	für ME 102	for ME 102	para ME 102	pour ME 102	per ME 102
80-070-03-04	für Minicutter	for Minicutter	para Minicutter	pour Minicutter	per Minicutter
80-070-04-04	für MD 62	for MD 62	para MD 62	pour MD 62	per MD 62



sätze für Großgeräte  
 ory sets for major electrosurgical units  
 de accesorios para gran aparatos  
 accessoires pour des grands appareils  
 li accessori per apparecchi grandi

0-00 Satz Zubehör monopolar für  
 ME 411/ME MB2/ME MB1/  
 ME M1/ME 401/ME 400/  
 ME 200/maXium® (m-Version),  
 Hand, groß, bestehend aus:

Accessory set monopolar for  
 ME 411/ME MB2/ME MB1/  
 ME 401/ME 400/ ME 200/  
 maXium® (m-version),  
 for hand switch operation,  
 large, consisting of:

Juego de accesorios monopolar  
 ME 411/ME MB2/ME MB1/ME  
 ME 401/ME 400/ME 200/  
 maXium® (versión m),  
 con interruptor digital, grande  
 compuesto de:

0-217-02	1	Handgriff mit Doppelschalter, 4 m Kabel	- Electrode handle with two finger switches and connection cable of 4 m	- Mango porta-electrodos con interruptor digital doble, cable de conexión d
0-342-03	1	Gummi-Neutralelektrode 15 x 26 cm, 4 m Kabel	- Rubber neutral electrode, 15 x 26 cm, with connection cable, 4 m	- Placa neutra de goma, 15 x 26 c
0-371-00	2	Gummibinden, gelocht, 100 cm	- Rubber bands, with holes, 100 cm	- Cintas de goma, perforadas, 100
0-371-01	2	Knöpfe für Gummibinde	- Buttons for rubber band	- Botones para la cinta de goma
0-416-00	1	Elektroden-Ständer für 16 Elektroden	- Electrode box for 16 electrodes	- Caja para 16 electrodos
0-510-04	1	Lanzettelektrode, gerade	- Lancet electrode, straight	- Electrodo de lanceta, recto
0-511-04	1	Lanzettelektrode, abgewinkelt	- Lancet electrode, angled	- Electrodo de lanceta, acodado
		Meißerlektrode	- Knife electrode	- Electrodo de cuchillo
			- Needle electrode	- Electrodo de aguja
			- Fine needle electrodes, extra fine	- Docena de electrodos de agu
				- Adaptador para electrodos d
				- Adaptador para electrodos d

ZUBEHÖRSÄTZE  
 ACCESSORY SETS  
 JUEGOS DE ACCESORIOS  
 JEUX D'ACCESSOIRES  
 SERIE DI ACCESSORI

161-183

Zubehörsätze für Großgeräte  
 Accessory sets for major electrosurgical units  
 Juegos de accesorios para gran aparatos  
 Jeux d'accessoires pour grands appareils  
 Serie di accessori per apparecchi grandi

80-140-00-04		Satz Zubehör monopolar für ME 411/ME MB 3/ME MB 2/ ME MB 1/ME M1/ME 401/ ME 400/ME 200/ maXium* („m“-Version), Hand, groß, bestehend aus:	Accessory set monopolar for ME 411/ME MB 3/ME MB 2/ ME MB 1/ME M1/ME 401/ ME 400/ ME 200/ maXium* ("m“-Version), for hand switch operation, large, consisting of:	Juego de accesorios monopolar para ME 411/ME MB 3/ME MB 2/ ME MB 1/ME M1/ ME 401/ME 400/ME 200/ maXium* (versión "m"), con interruptor digital, grande, compuesto de:
80-217-02-04	1	Handgriff mit Doppelschalter, 4 m Kabel	- Electrode handle with two finger switches and connection cable of 4 m	- Mango porta-electrodos con interruptor digital doble, cable de conexión de 4 m
80-342-03-04	1	Gummi-Neutralelektrode 15 x 26 cm, 4 m Kabel	- Rubber neutral electrode, 15 x 26 cm, with connection cable, 4 m	- Placa neutra de goma, 15 x 26 cm, cable de conexión de 4 m
80-371-00-04	2	Gummibinden, gelocht, 100 cm	- Rubber bands, with holes, 100 cm	- Cintas de goma, perforadas, 100 cm
80-371-01-04	2	Knöpfe für Gummibinde	- Buttons for rubber band	- Botones para la cinta de goma
80-416-00-01	1	Elektroden-Ständer für 16 Elektroden	- Electrode box for 16 electrodes	- Caja para 16 electrodos
80-505-00-04	1**	Reinigungspad für Elektroden, steril verpackt	- Cleaning pad for electrodes, sterile packed	- Almohadilla de limpieza para electrodos, embalado estéril
80-510-04-04	1	Lanzettelektrode, gerade	- Lancet electrode, straight	- Electrodo de lanceta, recto
80-511-04-04	1	Lanzettelektrode, abgewinkelt	- Lancet electrode, angled	- Electrodo de lanceta, acodado
80-515-04-04	1	Messerelektrode	- Knife electrode	- Electrodo de cuchillo
80-520-04-04	1	Nadelelektrode	- Needle electrode	- Electrodo de aguja
80-525-04-04	1	Dtz. Nadelelektroden, extra fein	- Doz. needle electrodes, extra fine	- Docena de electrodos de aguja, especialmente finos
80-532-00-04	1	Reduz.-Stück für Nadelelektroden	- Adapter for needle electrodes	- Adaptador para electrodos de aguja
80-540-04-04	1	Drahtschlingenelektrode, Ø 5 mm	- Wire loop electrode, Ø 5 mm	- Electrodo de asa de alambre, Ø 5 mm
80-542-04-04	1	Drahtschlingenelektrode, Ø 10 mm	- Wire loop electrode, Ø 10 mm	- Electrodo de asa de alambre, Ø 10 mm
80-550-04-04	1	Bandschlingenelektrode, Ø 10 mm	- Ribbon loop electrode, Ø 10 mm	- Electrodo de asa de cinta, Ø 10 mm
80-552-04-04	1	Bandschlingenelektrode, Ø 15 mm	- Ribbon loop electrode, Ø 15 mm	- Electrodo de asa de cinta, Ø 15 mm
80-560-04-04	1	Kugelelektrode, Ø 2 mm	- Ball electrode, Ø 2 mm	- Electrodo de bola, Ø 2 mm
80-562-04-04	1	Kugelelektrode, Ø 4 mm	- Ball electrode, Ø 4 mm	- Electrodo de bola, Ø 4 mm
80-563-04-04	1	Kugelelektrode, Ø 5 mm	- Ball electrode, Ø 5 mm	- Electrodo de bola, Ø 5 mm
80-570-04-04	1	Plattenelektrode, 8 x 10 mm	- Plate electrode, 8 x 10 mm	- Electrodo de placa, 8 x 10 mm

80-150-00-04		Satz bipolares Zubehör für KLS Martin maXium* („m“-Version), ME 411/ME MB 3/ ME MB 2/ME 401/ ME 400/ME 200/ME MB 1*	Set bipolar accessories for KLS Martin maXium* ("m“-Version), ME 411/ME MB 3/ME MB 2/ ME 401/ME 400/ ME 200/ ME MB 1*	Juego de accesorios bipolar para KLS Martin maXium* (versión "m"), ME 411/ME MB 3/ME MB 2/ ME 401/ME 400/ME 200/ ME MB 1*
80-287-53-04	1	Anschlusskabel für bipolare Pinzetten	- Connection cable for bipolar forceps	- Cable de conexión para pinzas bipolares
80-924-16-04	1	Bipolare Pinzette, gerade, stumpf, 16 cm/6 1/4"	- Bipolar forceps, straight, blunt, 16 cm/6 1/4"	- Pinza bipolar, recta, roma, 16 cm/6 1/4"
80-945-20-04	1	Bipolare Pinzette, bajonettförmig, stumpf, 20 cm/8"	- Bipolar forceps, bayonet-shaped, blunt, 20 cm/8"	- Pinza bipolar, en forma bayoneta, roma, 20 cm/8"
80-925-16-04	1	Bipolare Pinzette, abgewinkelt, stumpf, 16 cm/6 1/4"	- Bipolar forceps, angled, blunt, 16 cm/6 1/4"	- Pinza bipolar, acodada, roma, 16 cm/6 1/4"
80-925-20-04	1	Bipolare Pinzette, abgewinkelt, stumpf, 20 cm/8"	- Bipolar forceps, angled, blunt, 20 cm/8"	- Pinza bipolar, acodada, roma, 20 cm/8"
80-924-20-04	1	Bipolare Pinzette, gerade, stumpf, 20 cm/8"	- Bipolar forceps, straight, blunt, 20 cm/8"	- Pinza bipolar, recta, roma, 20 cm/8"

\* Nur in Verbindung mit Fußschalter  
 \*\* VE = 100 Stck.

\* Only in connection with foot switch  
 \*\* SU = 100/pack

\* Solamente en conexión con interruptor de pie  
 \*\* UV = 100 piezas

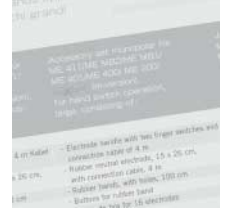

<b>80-140-00-04</b>		<b>Grand lot d'accessoires monopolaire pour ME 411/ME MB 3/ME MB 2/ME MB 1/ ME M1/ME 401/ME 400/ME 200, maXium® (version «m»), pour commande digitale, composé de:</b>	<b>Serie grande di accessori standard monopolare per ME 411/ME MB 3/ME MB 2/ME MB 1/ME M1/ ME 401/ME 400/ME 200, maXium® (versione "m"), per attivazione a mano, composta di:</b>
80-217-02-04	1	Manche porte-électrode avec interrupteur digital double et câble de raccordement de 4 m	- Manico portaelettrodi con interruttore doppio e cavo di connessione di 4 m
80-342-03-04	1	Electrode neutre en caoutchouc, 15 x 26 cm, avec câble de raccordement de 4 m	- Elettrodo neutro di gomma, 15 x 26 cm, cavo di connessione di 4 m
80-371-00-04	2	Bandes caoutchouc, perforées, 100 cm	- Nastri di gomma, perforati, 100 cm
80-371-01-04	2	Boutons pour bande caoutchouc	- Bottoni per nastro di gomma
80-416-00-01	1	Boîte pour 16 électrodes	- Supporto per 16 elettrodi in scatola
80-505-00-04	1**	Tampon de nettoyage pour électrodes, emballage stérile	- Tampone di pulizia per elettrodi, imballaggio sterile
80-510-04-04	1	Electrode lancette, droite	- Elettrodo a lancetta, retto
80-511-04-04	1	Electrode lancette, coudée	- Elettrodo a lancetta, angolato
80-515-04-04	1	Electrode couteau	- Elettrodo a bisturi
80-520-04-04	1	Electrode aiguille	- Elettrodo ad ago
80-525-04-04	1	Doz. d'électrodes aiguille, extra fines	- Elettrodo ad ago, strafino, doz.
80-532-00-04	1	Adaptateur pour électrodes aiguille	- Adattatore per elettrodi ad ago
80-540-04-04	1	Electrode anse en fil, Ø 5 mm	- Elettrodo ad ansa, Ø 5 mm
80-542-04-04	1	Electrode anse en fil, Ø 10 mm	- Elettrodo ad ansa, Ø 10 mm
80-550-04-04	1	Electrode boucle, Ø 10 mm	- Elettrodo ad ansa a nastro, Ø 10 mm
80-552-04-04	1	Electrode boucle, Ø 15 mm	- Elettrodo ad ansa a nastro, Ø 15 mm
80-560-04-04	1	Electrode boule, Ø 2 mm	- Elettrodo a sfera, Ø 2 mm
80-562-04-04	1	Electrode boule, Ø 4 mm	- Elettrodo a sfera, Ø 4 mm
80-563-04-04	1	Electrode boule, Ø 5 mm	- Elettrodo a sfera, Ø 5 mm
80-570-04-04	1	Electrode plaque, 8 x 10 mm	- Elettrodo a piastra, 8 x 10 mm

<b>80-150-00-04</b>		<b>Lot d'accessoires bipolaire pour KLS Martin maXium® (version «m»), ME 411/ME MB 3/ME MB 2/ME 401/ME 400/ ME 200/ME MB 1*</b>	<b>Set bipolar accessories for KLS Martin maXium® ("m"-Version), ME 411/ME MB 3/ME MB 2/ ME 401/ME 400/ ME 200/ ME MB 1*</b>
80-287-53-04	1	Câble de raccordement pour pinces bipolaires	- Connection cable for bipolar forceps
80-924-16-04	1	Pince bipolaire, droite, mousse, 16 cm/6 1/4"	- Bipolar forceps, straight, blunt, 16 cm/6 1/4"
80-945-20-04	1	Pince bipolaire, en forme baïonnette, mousse, 20 cm/8"	- Bipolar forceps, bayonet-shaped, blunt, 20 cm/8"
80-925-16-04	1	Pince bipolaire, coudée, mousse, 16 cm/6 1/4"	- Bipolar forceps, angled, blunt, 16 cm/6 1/4"
80-925-20-04	1	Pince bipolaire, coudée, mousse, 20 cm/8"	- Bipolar forceps, angled, blunt, 20 cm/8"
80-924-20-04	1	Pince bipolaire, droite, mousse, 20 cm/8"	- Bipolar forceps, straight, blunt, 20 cm/8"

\* Seulement en connexion d'interrupteur à pédale

\*\* UC = 100 pièces

\* Solamente in connessione con interruttore a pedale

\*\* UV = 100 pezzi

Zubehörsätze für Großgeräte  
 Accessory sets for major electrosurgical units  
 Juegos de accesorios para gran aparatos  
 Jeux d'accessoires pour grands appareils  
 Serie di accessori per apparecchi grandi

80-150-01-04		Satz bipolares Zubehör mit NON-STICK-red-Pinzetten für KLS Martin maXium* („m“-Version), ME 411/ME MB 3/ME MB 2/ME 401/ME 400/ME 200/ME MB 1*	Set bipolar accessories with NON-STICK red forceps for KLS Martin maXium* ("m"-Version), ME 411/ME MB 3/ME MB 2/ME 401/ME 400/ME 200/ME MB 1*	Juego de accesorios bipolar con pinzas bipolares NON-STICK red para KLS Martin maXium* (versión "m"), ME 411/ME MB 3/ME MB 2/ME 401/ME 400/ME 200/ME MB 1*
80-287-53-04	1	Anschlusskabel für bipolare Pinzetten	- Connection cable for bipolar forceps	- Cable de conexión para pinzas bipolares
80-986-17-04	1	Bipolare Pinzette, NON-STICK red, gerade, stumpf, 16 cm/6 1/4"	- Bipolar forceps, NON-STICK red, straight, blunt, 16 cm/6 1/4"	- Pinza bipolar, NON-STICK red, recta, roma, 16 cm/6 1/4"
80-992-20-04	1	Bipolare Pinzette, NON-STICK red, bajonettförmig, stumpf, 20 cm/8"	- Bipolar forceps, NON-STICK red, bayonet-shaped, blunt, 20 cm/8"	- Pinza bipolar, NON-STICK red, en forma bayoneta, roma, 20 cm/8"
80-987-17-04	1	Bipolare Pinzette, NON-STICK red, abgewinkelt, stumpf, 16 cm/6 1/4"	- Bipolar forceps, NON-STICK red, angled, blunt, 16 cm/6 1/4"	- Pinza bipolar, NON-STICK red, acodada, roma, 16 cm/6 1/4"
80-987-20-04	1	Bipolare Pinzette, NON-STICK red, abgewinkelt, stumpf, 20 cm/8"	- Bipolar forceps, NON-STICK red, angled, blunt, 20 cm/8"	- Pinza bipolar, NON-STICK red, acodada, roma, 20 cm/8"
80-986-20-04	1	Bipolare Pinzette, NON-STICK red, gerade, stumpf, 20 cm/8"	- Bipolar forceps, NON-STICK red, straight, blunt, 20 cm/8"	- Pinza bipolar, NON-STICK red, recta, roma, 20 cm/8"

80-140-01-04		Satz Zubehör ME 411/ME MB 3/ME MB 2/ME MB 1/ME M1/ME 401/ME 400/ME 200/maXium* („m“-Version), Fuß, groß, bestehend aus:	Accessory set for ME 411/ME MB 3/ME MB 2/ME MB 1/ME M1/ME 401/ME 400/ME 200/maXium* ("m"-version), for foot switch operation, large, consisting of:	Juego de accesorios ME 411/ME MB 3/ME MB 2/ME MB 1/ME M1/ME 401/ME 400/ME 200/maXium* (versión "m"), con interruptor de pedal, grande, compuesto de:
80-220-00-04	1	Handgriff ohne Schalter, 4 m Kabel	- Electrode handle without switch, with connection cable of 4 m	- Mango porta-electrodos sin interruptor, cable de conexión de 4 m
80-342-03-04	1	Gummi-Neutralelektrode 15 x 26 cm, 4 m Kabel	- Rubber neutral electrode, 15 x 26 cm, with connection cable of 4 m	- Placa neutra de goma, 15 x 26 cm, cable de conexión de 4 m
80-371-00-04	2	Gummibinden, gelocht, 100 cm	- Rubber bands, with holes, 100 cm	- Cintas de goma, perforadas, 100 cm
80-371-01-04	2	Knöpfe für Gummibinde	- Buttons for rubber band	- Botones para la cinta de goma
80-416-00-01	1	Elektroden-Ständer für 16 Elektroden	- Electrode box for 16 electrodes	- Caja para 16 electrodos
80-505-00-04	1*	Reinigungspad für Elektroden, steril verpackt	- Cleaning pad for electrodes, sterile packed	- Almohadilla de limpieza para electrodos, embalado estéril
80-510-04-04	1	Lanzettelektrode, gerade	- Lancet electrode, straight	- Electrodo de lanceta, recto
80-511-04-04	1	Lanzettelektrode, abgewinkelt	- Lancet electrode, angled	- Electrodo de lanceta, acodado
80-515-04-04	1	Messerelektrode	- Knife electrode	- Electrodo de cuchillo
80-520-04-04	1	Nadelelektrode	- Needle electrode	- Electrodo de aguja
80-525-04-04	1	Dtz. Nadelelektroden, extra fein	- Doz. needle electrodes, extra fine	- Docena de electrodos de aguja, especialmente finos
80-532-00-04	1	Reduz.-Stück für Nadelelektroden	- Adapter for needle electrodes	- Adaptador para electrodos de aguja
80-540-04-04	1	Drahtschlingenelektrode, Ø 5 mm	- Wire loop electrode, Ø 5 mm	- Electrodo de asa de alambre, Ø 5 mm
80-542-04-04	1	Drahtschlingenelektrode, Ø 10 mm	- Wire loop electrode, Ø 10 mm	- Electrodo de asa de alambre, Ø 10 mm
80-550-04-04	1	Bandschlingenelektrode, Ø 10 mm	- Ribbon loop electrode, Ø 10 mm	- Electrodo de asa de cinta, Ø 10 mm
80-552-04-04	1	Bandschlingenelektrode, Ø 15 mm	- Ribbon loop electrode, Ø 15 mm	- Electrodo de asa de cinta, Ø 15 mm
80-560-04-04	1	Kugelelektrode, Ø 2 mm	- Ball electrode, Ø 2 mm	- Electrodo de bola, Ø 2 mm
80-562-04-04	1	Kugelelektrode, Ø 4 mm	- Ball electrode, Ø 4 mm	- Electrodo de bola, Ø 4 mm
80-563-04-04	1	Kugelelektrode, Ø 5 mm	- Ball electrode, Ø 5 mm	- Electrodo de bola, Ø 5 mm
80-570-04-04	1	Plattenelektrode, 8 x 10 mm	- Plate electrode, 8 x 10 mm	- Electrodo de placa, 8 x 10 mm
80-821-02-04	1	Doppelpedal-Fußschalter, AP-geprüft, 5 m Kabel, explosionsgeschützt	- Double-pedal foot switch, anti-explosive, with connection cable of 5 m	- Interruptor de pedal doble, anti-explosivo, cable de conexión de 5 m

\* VE = 100 Stck.

\* SU = 100/pack

\* UV = 100 piezas



80-150-01-04		Lot d'accessoires bipolaire avec pinces bipolaires NON-STICK red pour KLS Martin maXium® (version «m»), ME 411/ ME MB 3/ME MB 2/ME 401/ME 400/ME 200/ ME MB 1*	Serie di accessori bipolare con pinze bipolari NON-STICK red per KLS Martin maXium® (versione "m"), ME 411/ ME MB 3/ME MB 2/ME 401/ME 400/ME 200/ ME MB 1*
80-287-53-04	1	Câble de raccordement pour pinces bipolaires	- Cavo di connessione per pinze bipolari
80-986-17-04	1	Pince bipolaire, NON-STICK red, droite, mousse, 16 cm/6 1/4"	- Pinza bipolare, NON-STICK red, retta, smussa, 16 cm/6 1/4"
80-992-20-04	1	Pince bipolaire, NON-STICK red, en forme baïonnette, mousse, 20 cm/8"	- Pinza bipolare, NON-STICK red, a forma baionetta, smussa, 20 cm/8"
80-987-17-04	1	Pince bipolaire, NON-STICK red, coudée, mousse, 16 cm/6 1/4"	- Pinza bipolare, NON-STICK red, angolata, smussa, 16 cm/6 1/4"
80-987-20-04	1	Pince bipolaire, NON-STICK red, coudée, mousse, 20 cm/8"	- Pinza bipolare, NON-STICK red, angolata, smussa, 20 cm/8"
80-986-20-04	1	Pince bipolaire, NON-STICK red, droite, mousse, 20 cm/8"	- Pinza bipolare, NON-STICK red, retta, smussa, 20 cm/8"

80-140-01-04		Grand lot d'accessoires ME 411/ ME MB 3/ME MB 2/ME MB 1/ME M1/ ME 401/ME 400/ME 200/ maXium® (version «m»), pour commande par pédale, composé de:	Serie grande di accessori standard ME 411/ ME MB 3/ME MB 2/ME MB 1/ME M1/ME 401/ ME 400/ME 200/ maXium® (versione "m"), per attivazione a pedale, composta di:
80-220-00-04	1	Manche porte-électrode sans interrupteur avec câble de raccordement de 4 m	- Manico portaelettrodi senza interruttore, cavo di connessione di 4 m
80-342-03-04	1	Electrode neutre en caoutchouc, 15 x 26 cm, avec câble de raccordement de 4 m	- Elettrodo neutro di gomma, 15 x 26 cm, cavo di connessione di m 4
80-371-00-04	2	Bandes caoutchouc, perforées, 100 cm	- Nastri di gomma, perforati, 100 cm
80-371-01-04	2	Boutons pour bande caoutchouc	- Bottoni per nastro di gomma
80-416-00-01	1	Boîte pour 16 électrodes	- Supporto per 16 elettrodi in scatola
80-505-00-04	1*	Tampon de nettoyage pour électrodes, emballage stérile	- Tampone di pulizia per elettrodi, imballaggio sterile
80-510-04-04	1	Electrode lancette, droite	- Elettrodo a lancetta, retto
80-511-04-04	1	Electrode lancette, coudée	- Elettrodo a lancetta, angolato
80-515-04-04	1	Electrode couteau	- Elettrodo a bisturi
80-520-04-04	1	Electrode aiguille	- Elettrodo ad ago
80-525-04-04	1	Doz. d'électrodes aiguille, extra fines	- Elettrodo ad ago, strafino, dozz.
80-532-00-04	1	Adaptateur pour électrodes aiguille	- Adattatore per elettrodi ad ago
80-540-04-04	1	Electrode anse en fil, Ø 5 mm	- Elettrodo ad ansa, Ø 5 mm
80-542-04-04	1	Electrode anse en fil, Ø 10 mm	- Elettrodo ad ansa, Ø 10 mm
80-550-04-04	1	Electrode boucle, Ø 10 mm	- Elettrodo ad ansa a nastro, Ø 10 mm
80-552-04-04	1	Electrode boucle, Ø 15 mm	- Elettrodo ad ansa a nastro, Ø 15 mm
80-560-04-04	1	Electrode boucle, Ø 2 mm	- Elettrodo a sfera, Ø 2 mm
80-562-04-04	1	Electrode boucle, Ø 4 mm	- Elettrodo a sfera, Ø 4 mm
80-563-04-04	1	Electrode boucle, Ø 5 mm	- Elettrodo a sfera, Ø 5 mm
80-570-04-04	1	Electrode plaque, 8 x 10 mm	- Elettrodo a piastra, 8 x 10 mm
80-821-02-04	1	Interrupteur à pédale double, anti-explosif, avec câble de raccordement de 5 m	- Interruttore a pedale doppio, anti-deflagrante, con cavo di connessione di 5 m

\* UC = 100 pièces

\* UV = 100 pezzi

Zubehörsätze für Großgeräte  
 Accessory sets for major electrosurgical units  
 Juegos de accesorios para gran aparatos  
 Jeux d'accessoires pour grands appareils  
 Serie di accessori per apparecchi grandi

80-140-02-04		Satz Zubehör ME 411/ ME MB 3/ME MB 2/ ME MB 1/ME M1/ME 401/ ME 400/ME 200, maXium® („m“-Version), Hand, klein, bestehend aus:	Accessory set for ME 411/ ME MB 3/ME MB 2/ ME MB 1/ME M1/ME 401/ME 400/ ME 200, maXium® (“m“-version), for hand switch operation, small, consisting of:	Juego de accesorios ME 411/ ME MB 3/ME MB 2/ME MB 1/ ME M1/ME 401/ ME 400/ME 200 maXium® (versión “m”), con interruptor digital, pequeño, compuesto de:
80-217-02-04	1	Handgriff mit Doppelschalter, 4 m Kabel	- Electrode handle with two finger switches and connection cable of 4 m	- Mango porta-electrodos con interruptor digital doble y cable de conexión de 4 m
80-342-03-04	1	Gummi-Neutralelektrode 15 x 26 cm, 4 m Kabel	- Rubber neutral electrode, 15 x 26 cm, with connection cable of 4 m	- Placa neutra de goma, 15 x 26 cm, cable de conexión de 4 m
80-372-00-04	1	Textilband mit Klettverschluss, 90 cm	- Textile band with velcro strap, 90 cm	- Tira auto-adhesiva, 90 cm
80-505-00-04	1***	Reinigungspad für Elektroden, steril verpackt	- Cleaning pad for electrodes, sterile packed	- Almohadilla de limpieza para electrodos, embalado estéril
80-511-04-04	1	Lanzettelektrode, abgewinkelt	- Lancet electrode, straight	- Electrodo de lanceta, acodado
80-515-04-04	1	Messerelektrode	- Knife electrode	- Electrodo de cuchillo
80-520-04-04	1	Nadelelektrode	- Needle electrode	- Electrodo de aguja
80-562-04-04	1	Kugelelektrode, Ø 4 mm	- Ball electrode, Ø 4 mm	- Electrodo de bola, Ø 4 mm

Ergänzungs-Sets

Supplementary sets

Juegos suplementarios

80-160-00-04		Standard-Set A für ME MB 3 m, ME MB 2 m und ME MB 1 (und andere KLS-Martin-Großgeräte) bestehend aus:	Standard Set A for ME MB 3 m, ME MB 2 m and ME MB 1 (and other KLS Martin major electrosurgical units) consisting of:	Juego estándar A para ME MB 3 m, ME MB 2 m y ME MB 1 (y otros equipos grandes KLS Martin) compuesto de:
80-221-02-04	1*	Einmalhandgriffe	- Disposable electrode handles	- Mangos desechables
80-344-09-04	1**	PCS-DuoSafe-Einmal-Neutralelektroden	- Disposable DuoSafe neutral electrodes	- Placas neutras desechables PCS DuoSafe
80-294-40-04	1	Neutralelektroden-Anschlusskabel KLS Martin	- KLS Martin connection cable for disposable neutral electrodes	- Cable de conexión KLS Martin para placa neutra
80-505-00-04	1***	Reinigungspad für Elektroden, steril verpackt	- Cleaning pad for electrodes, sterile packed	- Almohadilla de limpieza para electrodos, embalado estéril
80-811-30-04	1	Fußschalter	- Foot switch	- Interruptor de pedal

80-160-01-04		Standard-Set B für ME MB 3 i und ME MB 2 i maXium® („i“-Version), bestehend aus:	Standard Set B for ME MB 3 i and ME MB 2 i maXium® (“i“-version), consisting of:	Juego estándar B para ME MB 3 i y ME MB 2 i maXium® (versión “i”), compuesto de:
80-221-02-04	1*	Einmalhandgriffe	- Disposable electrode handles	- Mangos desechables
80-344-09-04	1**	PCS-DuoSafe-Einmal-Neutralelektroden	- Disposable DuoSafe neutral electrodes	- Placas neutras desechables PCS DuoSafe
80-294-44-04	1	Neutralelektroden-Anschlusskabel Valleylab	- Connection cable Valleylab for disposable neutral electrodes	- Cable de conexión Valleylab para electrodo neutro
80-505-00-04	1***	Reinigungspad für Elektroden, steril verpackt	- Cleaning pad for electrodes, sterile packed	- Almohadilla de limpieza para electrodos, embalado estéril
80-811-30-04	1	Fußschalter	- Foot switch	- Interruptor de pedal

\* VE = 10 Stck.  
 \*\* VE = 50 Stck.  
 \*\*\* VE = 100 Stck.

\* SU = 10/pack  
 \*\* SU = 50/pack  
 \*\*\* SU = 100/pack

\* UV = 10 piezas  
 \*\* UV = 50 piezas  
 \*\*\* UV = 100 piezas





<b>80-140-02-04</b>		<b>Petit lot d'accessoires</b> <b>ME 411/ME MB 3/ME MB 2/ME MB 1/</b> <b>ME M1/ME 401/ME 400/ME 200,</b> <b>maXium® (version «m»),</b> <b>pour commande digitale,</b> <b>composé de:</b>	<b>Serie piccola di accessori standard</b> <b>ME 411/ME MB 3/ME MB 2/ME MB 1/ME M1/</b> <b>ME 401/ME 400/ME 200,</b> <b>maXium® (versione "m"),</b> <b>per attivazione a mano,</b> <b>composta di:</b>
80-217-02-04	1	Manche porte-électrode avec interrupteur digital double et câble de raccordement de 4 m	- Manico portaelettrodi con interruttore doppio e cavo di connessione di 4 m
80-342-03-04	1	Électrode neutre en caoutchouc, 15 x 26 cm, avec câble de raccordement de 4 m	- Elettrodo neutro di gomma, 15 x 26 cm, cavo di connessione di 4 m
80-372-00-04	1	Bande auto-adhésive, 90 cm	- Nastro tessile auto-adesivo, 90 cm
80-505-00-04	1***	Tampon de nettoyage pour électrodes, emballage stérile	- Tampone di pulizia per elettrodi, imballaggio sterile
80-511-04-04	1	Électrode lancette, coudée	- Elettrodo a lancetta, angolato
80-515-04-04	1	Électrode couteau	- Elettrodo a bisturi
80-520-04-04	1	Électrode aiguille	- Elettrodo ad ago
80-562-04-04	1	Électrode boule, Ø 4 mm	- Elettrodo a sfera, Ø 4 mm

### Lots supplémentaires

### Set supplementari

<b>80-160-00-04</b>		<b>Lot standard A</b> <b>pour ME MB 3 m, ME MB 2 m et ME MB 1</b> <b>(et autres grands appareils KLS Martin)</b> <b>composé de:</b>	<b>Set standard A</b> <b>per l'apparecchio ME MB 3 m, ME MB 2 m e</b> <b>ME MB 1 (e altri grandi apparecchi KLS Martin)</b> <b>composto di:</b>
80-221-02-04	1*	Manches à usage unique	- Manici monouso
80-344-09-04	1**	Électrodes neutres à usage unique type PCS DuoSafe	- Elettrodi neutri PCS DuoSafe monouso
80-294-40-04	1	Câble de raccordement à électrode neutre KLS Martin	- Cavo di connessione KLS Martin per elettrodo neutro
80-505-00-04	1***	Tampon de nettoyage pour électrodes, emballage stérile	- Tampone di pulizia per elettrodi, imballaggio sterile
80-811-30-04	1	Interrupteur à pédale	- Interruttore a pedale

<b>80-160-01-04</b>		<b>Lot standard B</b> <b>pour ME MB 3 i et ME MB 2 i</b> <b>maXium® (version «i»),</b> <b>composé de:</b>	<b>Set standard B</b> <b>per l'apparecchio ME MB 3 i e ME MB 2 i</b> <b>maXium® (versione "i"),</b> <b>composto di:</b>
80-221-02-04	1*	Manches à usage unique	- Manici monouso
80-344-09-04	1**	Électrodes neutres à usage unique type PCS DuoSafe	- Elettrodi neutri PCS DuoSafe monouso
80-294-44-04	1	Câble de raccordement à électrode neutre Valleylab	- Cavo di connessione Valleylab per elettrodo neutro
80-505-00-04	1***	Tampon de nettoyage pour électrodes, emballage stérile	- Tampone di pulizia per elettrodi, imballaggio sterile
80-811-30-04	1	Interrupteur à pédale	- Interruttore a pedale

\* UC = 10 pièces  
\*\* UC = 50 pièces  
\*\*\* UC = 100 pièces

\* UV = 10 pezzi  
\*\* UV = 50 pezzi  
\*\*\* UV = 100 pezzi

Zubehörsätze für Großgeräte  
 Accessory sets for major electrosurgical units  
 Juegos de accesorios para gran aparatos  
 Jeux d'accessoires pour grands appareils  
 Serie di accessori per apparecchi grandi

80-160-02-04		Standard-Set C für ME MB 3 i, ME MB 2 i, maXium® i (und weitere Geräte mit internationalem Anschluss) bestehend aus:	Standard set C for ME MB 3 i, ME MB 2 i, maXium® i (and other units with international connector sockets) consisting of:	Juego estándar C para ME MB 3 i, ME MB 2 i, maXium® i (y otros equipos con conexión internacional) compuesto de:
80-210-02-04	5	Elektroden-Handgriff mit zwei Tasten für 2,4-mm-Elektroden, mit 3-Pin-Stecker und 3 m Anschlusskabel, semi-disposable	Electrode handle with two pushbuttons for 2.4-mm electrodes, with 3-pin plug and connection cable of 3 m, semi-disposable	Mango porta-electrodos con dos teclas para 2,4 mm electrodos, con clavija de 3 patillas y cable de conexión de 3 m, semi-desechable
80-562-08-04	5	Kugelelektrode Ø 4 mm, Schaft Ø 2,4 mm	Ball electrode Ø 4 mm, shaft Ø 2.4 mm	Electrodo de bola Ø 4 mm, vástago Ø 2,4 mm
80-520-08-04	5	Nadelelektrode, Schaft Ø 2,4 mm	Needle electrode, shaft Ø 2.4 mm	Electrodo de aguja, vástago Ø 2,4 mm
80-515-08-04	5	Messerelektrode, Schaft Ø 2,4 mm	Knife electrode, shaft Ø 2.4 mm	Electrodo de cuchillo, vástago Ø 2,4 mm
80-510-08-04	5	Lanzettelektrode, Schaft Ø 2,4 mm	Lancet electrode, shaft Ø 2.4 mm	Electrodo de lanceta, vástago Ø 2,4 mm
80-542-08-04	5	Drahtschlingenelektrode Ø 10 mm, Schaft Ø 2,4 mm	Wire loop electrode Ø 10 mm, shaft Ø 2.4 mm	Electrodo de asa de alambre Ø 10 mm, vástago Ø 2,4 mm
80-344-09-04	1*	PCS-DuoSafe-Einmal-Neutralelektroden	Disposable DuoSafe neutral electrodes	Placas neutras desechables PCS DuoSafe
80-294-44-04	1	Neutralelektroden-Anschlusskabel mit i-Stecker (Typ Valleylab)	Connection cable for neutral electrodes with „i“-Version plug (type Valleylab)	Cable de conexión para placas neutras con clavija versión "i" (tipo Valleylab)
80-811-30-04	1	Doppelpedal-Fußschalter	Double-pedal foot switch	Interruptor de pie doble
80-505-00-04	1**	Reinigungspad für Elektroden, steril verpackt	Cleaning pad for electrodes, sterile packed	Almohadilla de limpieza para electrodos, embalado estéril

\* VE = 50 Stck.  
 \*\* VE = 100 Stck.

\* SU = 50/pack  
 \*\* SU = 100/pack

\* UV = 50 piezas  
 \*\* UV = 100 piezas

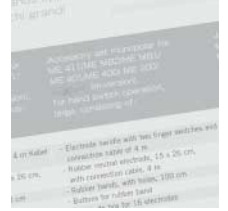

80-160-02-04		Lot standard C pour ME MB 3 i, ME MB 2 i, maXium® i (et autres appareils avec connexion internationale) composé de:	Set standard C per l'apparecchio ME MB 3 i, ME MB 2 i, maXium® i (e altri apparecchi con connessione internazionale) composto di:
80-210-02-04	5	Manche porte-électrode avec interrupteur digital double pour 2,4 mm électrodes, avec fiche à 3 broches et câble de raccordement de 3 m, réutilisable à plusieurs fois	Manico portaelettrodi con due tasti per 2,4 mm elettrodi, con spina a 3-spire e cavo di connessione da 3 m, semi-riutilizzabile
80-562-08-04	5	Electrode boule Ø 4 mm, tige Ø 2,4 mm	Elettrodo a sfera Ø 4 mm, asta Ø 2,4 mm
80-520-08-04	5	Electrode aiguille, tige Ø 2,4 mm	Elettrodo ad ago, asta Ø 2,4 mm
80-515-08-04	5	Electrode couteau, tige Ø 2,4 mm	Elettrodo a bisturi, asta Ø 2,4 mm
80-510-08-04	5	Electrode lancette, tige Ø 2,4 mm	Elettrodo a lancetta, asta Ø 2,4 mm
80-542-08-04	5	Electrode anse en fil Ø 10 mm, tige Ø 2,4 mm	Elettrodo ad ansa di filo Ø 10 mm, asta Ø 2,4 mm
80-344-09-04	1*	Électrodes neutres à usage unique type PCS DuoSafe	Elettrodi neutri PCS DuoSafe monouso
80-294-44-04	1	Câble de raccordement pour électrodes neutres avec fiche version «i» (type Valleylab)	Cavo di connessione per elettrodi neutri con spina versione "i" (tipo Valleylab)
80-811-30-04	1	Interrupteur à pédale double	Interruttore a doppio pedale
80-505-00-04	1**	Tampon de nettoyage pour électrodes, emballage stérile	Tampone di pulizia per elettrodi, imballaggio sterile

\* UC = 50 pièces  
\*\* UC = 100 pièces

\* UV = 50 pezzi  
\*\* UV = 100 pezzi

maxium®-Zubehörsätze für die Offene Chirurgie  
maxium® accessory sets for open surgery  
Juegos de accesorios maxium® para la cirugía abierta  
Jeux d'accessoires maxium® pour la chirurgie ouverte  
Serie di accessori maxium® per la chirurgia aperta

80-042-10-04		Satz Zubehör für maXium® m, bestehend aus:	Accessory set for maXium® m, consisting of:	Juego de accesorios para maXium® m, compuesto de:
80-811-30-04	1	Doppelpedal-Fußschalter	Double-pedal foot switch	Interruptor de pie doble
80-811-50-04	1	Einpedal-Fußschalter	Foot switch	Interruptor de pie
80-260-50-04	1	Potentialausgleichskabel	Potential equalization cable	Cable de conexión equipotencial
80-217-12-04	2	Elektroden-Handgriff	Electrode handle	Mango porta-electrodos
80-510-04-04	2	Lanzettelektrode	Lancet electrode	Electrodo de lanceta
80-511-04-04	2	Lanzettelektrode, abgewinkelt	Lancet electrode, angled	Electrodo de lanceta, acodado
80-515-04-04	2	Messerelektrode	Knife electrode	Electrodo de cuchillo
80-560-04-04	2	Kugelelektrode Ø 2 mm	Ball electrode Ø 2 mm	Electrodo de bola Ø 2 mm
80-344-09-04	1*	PCS-DuoSafe-Einmal-Neutralelektroden	Disposable DuoSafe neutral electrodes	Placas neutras desechables PCS DuoSafe
80-294-40-04	1	Anschlusskabel für Neutralelektroden	Connection cable for neutral electrodes	Cable de conexión para placas neutras
80-924-16-04	2	Bipolare Pinzette, gerade, stumpf	Bipolar forceps, straight, blunt	Pinzas bipolares, rectas, romas
80-287-33-04	4	Anschlusskabel für bipolare Instrumente	Connection cable for bipolar instruments	Cable de conexión para instrumentos bipolares
80-971-23-04	2	marClamp®, gebogene Version, 23 cm	marClamp®, curved version, 23 cm	marClamp®, versión curva, 23 cm
80-570-23-04	2	marCut®, 23 cm	marCut®, 23 cm	marCut®, 23 cm
80-505-00-04	1**	Reinigungspad für Elektroden, steril verpackt	Cleaning pad for electrodes, sterile packed	Almohadilla de limpieza para electrodos, embalado estéril

80-042-20-04		Satz Zubehör für maXium® i, bestehend aus:	Accessory set for maXium® i, consisting of:	Juego de accesorios para maXium® i, compuesto de:
80-811-30-04	1	Doppelpedal-Fußschalter	Double-pedal foot switch	Interruptor de pie doble
80-811-50-04	1	Einpedal-Fußschalter	Foot switch	Interruptor de pie
80-260-50-04	1	Potentialausgleichskabel	Potential equalization cable	Cable de conexión equipotencial
80-210-12-04	2	Elektroden-Handgriff	Electrode handle	Mango porta-electrodos
80-510-04-04	2	Lanzettelektrode	Lancet electrode	Electrodo de lanceta
80-511-04-04	2	Lanzettelektrode, abgewinkelt	Lancet electrode, angled	Electrodo de lanceta, acodado
80-515-04-04	2	Messerelektrode	Knife electrode	Electrodo de cuchillo
80-560-04-04	2	Kugelelektrode Ø 2 mm	Ball electrode Ø 2 mm	Electrodo de bola Ø 2 mm
80-344-09-04	1*	PCS-DuoSafe-Einmal-Neutralelektroden	Disposable DuoSafe neutral electrodes	Placas neutras desechables PCS DuoSafe
80-294-44-04	1	Anschlusskabel für Neutralelektroden	Connection cable for neutral electrodes	Cable de conexión para placas neutras
80-924-16-04	2	Bipolare Pinzette, gerade, stumpf	Bipolar forceps, straight, blunt	Pinzas bipolares, rectas, romas
80-287-89-04	4	Anschlusskabel für bipolare Instrumente	Connection cable for bipolar instruments	Cable de conexión para instrumentos bipolares
80-971-23-04	2	marClamp®, gebogene Version, 23 cm	marClamp®, curved version, 23 cm	marClamp®, versión curva, 23 cm
80-570-23-04	2	marCut®, 23 cm	marCut®, 23 cm	marCut®, 23 cm
80-505-00-04	1**	Reinigungspad für Elektroden, steril verpackt	Cleaning pad for electrodes, sterile packed	Almohadilla de limpieza para electrodos, embalado estéril

80-042-40-04		Satz Zubehör für maXium® e, bestehend aus:	Accessory set for maXium® e, consisting of:	Juego de accesorios para maXium® e, compuesto de:
80-811-30-04	1	Doppelpedal-Fußschalter	Double-pedal foot switch	Interruptor de pie doble
80-811-50-04	1	Einpedal-Fußschalter	Foot switch	Interruptor de pie
80-260-50-04	1	Potentialausgleichskabel	Potential equalization cable	Cable de conexión equipotencial
80-217-32-04	2	Elektroden-Handgriff	Electrode handle	Mango porta-electrodos
80-510-04-04	2	Lanzettelektrode	Lancet electrode	Electrodo de lanceta
80-511-04-04	2	Lanzettelektrode, abgewinkelt	Lancet electrode, angled	Electrodo de lanceta, acodado
80-515-04-04	2	Messerelektrode	Knife electrode	Electrodo de cuchillo
80-560-04-04	2	Kugelelektrode Ø 2 mm	Ball electrode Ø 2 mm	Electrodo de bola Ø 2 mm
80-344-09-04	1*	PCS-DuoSafe-Einmal-Neutralelektroden	Disposable DuoSafe neutral electrodes	Placas neutras desechables PCS DuoSafe
80-294-40-04	1	Anschlusskabel für Neutralelektroden	Connection cable for neutral electrodes	Cable de conexión para placas neutras
80-924-16-04	2	Bipolare Pinzette, gerade, stumpf	Bipolar forceps, straight, blunt	Pinzas bipolares, rectas, romas
80-287-89-04	4	Anschlusskabel für bipolare Instrumente	Connection cable for bipolar instruments	Cable de conexión para instrumentos bipolares
80-971-23-04	2	marClamp®, gebogene Version, 23 cm	marClamp®, curved version, 23 cm	marClamp®, versión curva, 23 cm
80-570-23-04	2	marCut®, 23 cm	marCut®, 23 cm	marCut®, 23 cm
80-505-00-04	1**	Reinigungspad für Elektroden, steril verpackt	Cleaning pad for electrodes, sterile packed	Almohadilla de limpieza para electrodos, embalado estéril

\* VE = 50 Stck.  
\*\* VE = 100 Stck.

\* SU = 50/pack  
\*\* SU = 100/pack

\* UV = 50 piezas  
\*\* UV = 100 piezas



<b>80-042-10-04</b>		<b>Lot d'accessoires pour maXium<sup>®</sup> m, composé de:</b>	<b>Serie di accessori per maXium<sup>®</sup> m, composta di:</b>
80-811-30-04	1	Interrupteur à pédale double	Interruttore a doppio pedale
80-811-50-04	1	Interrupteur à pédale	Interruttore a pedale
80-260-50-04	1	Câble de compensation de potentiel	Cavo per collegamento equipotenziale
80-217-12-04	2	Manche porte-électrode	Manico portaelettrodi
80-510-04-04	2	Electrode lancette	Elettrodo a lancetta
80-511-04-04	2	Electrode lancette, coudée	Elettrodo a lancetta, angolato
80-515-04-04	2	Electrode couteau	Elettrodo a bisturi
80-560-04-04	2	Electrode boule Ø 2 mm	Elettrodo a sfera Ø 2 mm
80-344-09-04	1*	Electrodes neutres à usage unique type PCS DuoSafe	Elettrodi neutri PCS DuoSafe monouso
80-294-40-04	1	Câble de raccordement pour électrodes neutres	Cavo di connessione per elettrodi neutri
80-924-16-04	2	Pinces bipolaires, droites, mousses	Pinze bipolari, strette, smusse
80-287-33-04	4	Câble de raccordement pour instruments bipolaires	Cavo di connessione per strumenti bipolari
80-971-23-04	2	marClamp <sup>®</sup> , version courbe, 23 cm	marClamp <sup>®</sup> , versione curva, 23 cm
80-570-23-04	2	marCut <sup>®</sup> , 23 cm	marCut <sup>®</sup> , 23 cm
80-505-00-04	1**	Tampon de nettoyage pour électrodes, emballage stérile	Tampone di pulizia per elettrodi, imballaggio sterile

<b>80-042-20-04</b>		<b>Lot d'accessoires pour maXium<sup>®</sup> i, composé de:</b>	<b>Serie di accessori per maXium<sup>®</sup> i, composta di:</b>
80-811-30-04	1	Interrupteur à pédale double	Interruttore a doppio pedale
80-811-50-04	1	Interrupteur à pédale	Interruttore a pedale
80-260-50-04	1	Câble de compensation de potentiel	Cavo per collegamento equipotenziale
80-210-12-04	2	Manche porte-électrode	Manico portaelettrodi
80-510-04-04	2	Electrode lancette	Elettrodo a lancetta
80-511-04-04	2	Electrode lancette, coudée	Elettrodo a lancetta, angolato
80-515-04-04	2	Electrode couteau	Elettrodo a bisturi
80-560-04-04	2	Electrode boule Ø 2 mm	Elettrodo a sfera Ø 2 mm
80-344-09-04	1*	Electrodes neutres à usage unique type PCS DuoSafe	Elettrodi neutri PCS DuoSafe monouso
80-294-44-04	1	Câble de raccordement pour électrodes neutres	Cavo di connessione per elettrodi neutri
80-924-16-04	2	Pinces bipolaires, droites, mousses	Pinze bipolari, strette, smusse
80-287-89-04	4	Câble de raccordement pour instruments bipolaires	Cavo di connessione per strumenti bipolari
80-971-23-04	2	marClamp <sup>®</sup> , version courbe, 23 cm	marClamp <sup>®</sup> , versione curva, 23 cm
80-570-23-04	2	marCut <sup>®</sup> , 23 cm	marCut <sup>®</sup> , 23 cm
80-505-00-04	1**	Tampon de nettoyage pour électrodes, emballage stérile	Tampone di pulizia per elettrodi, imballaggio sterile

<b>80-042-40-04</b>		<b>Lot d'accessoires pour maXium<sup>®</sup> e, composé de:</b>	<b>Serie di accessori per maXium<sup>®</sup> e, composta di:</b>
80-811-30-04	1	Interrupteur à pédale double	Interruttore a doppio pedale
80-811-50-04	1	Interrupteur à pédale	Interruttore a pedale
80-260-50-04	1	Câble de compensation de potentiel	Cavo per collegamento equipotenziale
80-217-32-04	2	Manche porte-électrode	Manico portaelettrodi
80-510-04-04	2	Electrode lancette	Elettrodo a lancetta
80-511-04-04	2	Electrode lancette, coudée	Elettrodo a lancetta, angolato
80-515-04-04	2	Electrode couteau	Elettrodo a bisturi
80-560-04-04	2	Electrode boule Ø 2 mm	Elettrodo a sfera Ø 2 mm
80-344-09-04	1*	Electrodes neutres à usage unique type PCS DuoSafe	Elettrodi neutri PCS DuoSafe monouso
80-294-40-04	1	Câble de raccordement pour électrodes neutres	Cavo di connessione per elettrodi neutri
80-924-16-04	2	Pinces bipolaires, droites, mousses	Pinze bipolari, strette, smusse
80-287-89-04	4	Câble de raccordement pour instruments bipolaires	Cavo di connessione per strumenti bipolari
80-971-23-04	2	marClamp <sup>®</sup> , version courbe, 23 cm	marClamp <sup>®</sup> , versione curva, 23 cm
80-570-23-04	2	marCut <sup>®</sup> , 23 cm	marCut <sup>®</sup> , 23 cm
80-505-00-04	1**	Tampon de nettoyage pour électrodes, emballage stérile	Tampone di pulizia per elettrodi, imballaggio sterile

\* UC = 50 pièces  
\*\* UC = 100 pièces

\* UV = 50 pezzi  
\*\* UV = 100 pezzi

maxium®-Beamer-Zubehörsätze für die Offene Chirurgie  
maxium® Beamer accessory sets for open surgery  
Juegos de accesorios maxium® Beamer para la cirugía abierta  
Jeux d'accessoires maxium® Beamer pour la chirurgie ouverte  
Serie di accessori maxium® Beamer per la chirurgia aperta

80-042-11-04		Satz Zubehör für maXium® m, bestehend aus:	Accessory set for maXium® m, consisting of:	Juego de accesorios para maXium® m, compuesto de:
80-181-52-04	1	Druckminderer (D, A, ...)	Pressure reducer (D, A, ...)	Manorreductor (D, A, ...)
80-811-30-04	1	Doppelpedal-Fußschalter	Double-pedal foot switch	Interrupor de pie doble
80-811-50-04	1	Einpedal-Fußschalter	Foot switch	Interrupor de pie
80-260-50-04	1	Potentialausgleichskabel	Potential equalization cable	Cable de conexión equipotencial
80-181-02-04	2	Beamer-Handgriff	Beamer handle	Mango Beamer
80-181-10-04	2	Beamer-Elektrode	Beamer electrode	Electrodo Beamer
80-181-13-04	2	Beamer-Lanzettelektrode	Beamer lancet electrode	Electrodo de lanceta Beamer
80-181-15-04	2	Beamer-Nadelelektrode	Beamer needle electrode	Electrodo de aguja Beamer
80-344-09-04	1*	PCS-DuoSafe-Einmal-Neutralelektroden	PCS disposable neutral electrode,	Placas neutras desechables PCS DuoSafe
80-294-40-04	1	Anschlusskabel für Neutralelektroden	Connection cable for neutral electrodes	Cable de conexión para placas neutras
80-924-16-04	2	Bipolare Pinzette, gerade, stumpf	Bipolar forceps, straight, blunt	Pinzas bipolares, rectas, romas
80-287-33-04	4	Anschlusskabel für bipolare Instrumente	Connection cable for bipolar instruments	Cable de conexión para instrumentos bipolares
		<b>Optional:</b>	<b>Optional:</b>	<b>Opcional:</b>
94-179-58-04	1	Gasflasche mit Füllung	Gas cylinder, filled	Botella de gas con relleno
80-047-00-04	1	maxium® Cart II	maxium® Cart II	maxium® Cart II
80-971-23-04	2	marClamp®, gebogene Version, 23 cm	marClamp®, curved version, 23 cm	marClamp®, versión curva, 23 cm
80-570-23-04	2	marCut®, 23 cm	marCut®, 23 cm	marCut®, 23 cm

80-042-21-04		Satz Zubehör für maXium® i, bestehend aus:	Accessory set for maXium® i, consisting of:	Juego de accesorios para maXium® i, compuesto de:
80-181-53-04	1	Druckminderer (NL, DK, ...)	Pressure reducer (NL, DK, ...)	Manorreductor (NL, DK, ...)
80-811-30-04	1	Doppelpedal-Fußschalter	Double-pedal foot switch	Interrupor de pie doble
80-811-50-04	1	Einpedal-Fußschalter	Foot switch	Interrupor de pie
80-260-50-04	1	Potentialausgleichskabel	Potential equalization cable	Cable de conexión equipotencial
80-181-02-04	2	Beamer-Handgriff	Beamer handle	Mango Beamer
80-181-10-04	2	Beamer-Elektrode	Beamer electrode	Electrodo Beamer
80-181-13-04	2	Beamer-Lanzettelektrode	Beamer lancet electrode	Electrodo de lanceta Beamer
80-181-15-04	2	Beamer-Nadelelektrode	Beamer needle electrode	Electrodo de aguja Beamer
80-344-09-04	1*	PCS-DuoSafe-Einmal-Neutralelektroden	Disposable DuoSafe neutral electrodes	Placas neutras desechables PCS DuoSafe
80-294-44-04	1	Anschlusskabel für Neutralelektroden	Connection cable for neutral electrodes	Cable de conexión para placas neutras
80-924-16-04	2	Bipolare Pinzette, gerade, stumpf	Bipolar forceps, straight, blunt	Pinzas bipolares, rectas, romas
80-287-89-04	4	Anschlusskabel für bipolare Instrumente	Connection cable for bipolar instruments	Cable de conexión para instrumentos bipolares
		<b>Optional:</b>	<b>Optional:</b>	<b>Opcional:</b>
94-179-58-04	1	Gasflasche mit Füllung	Gas cylinder, filled	Botella de gas con relleno
80-047-00-04	1	maxium® Cart II	maxium® Cart II	maxium® Cart II
80-971-23-04	2	marClamp®, gebogene Version, 23 cm	marClamp®, curved version, 23 cm	marClamp®, versión curva, 23 cm
80-570-23-04	2	marCut®, 23 cm	marCut®, 23 cm	marCut®, 23 cm

80-042-41-04		Satz Zubehör für maXium® e, bestehend aus:	Accessory set for maXium® e, consisting of:	Juego de accesorios para maXium® e, compuesto de:
80-181-55-04	1	Druckminderer (UK ...)	Pressure reducer (UK ...)	Manorreductor (UK ...)
80-811-30-04	1	Doppelpedal-Fußschalter	Double-pedal foot switch	Interrupor de pie doble
80-811-50-04	1	Einpedal-Fußschalter	Foot switch	Interrupor de pie
80-260-50-04	1	Potentialausgleichskabel	Potential equalization cable	Cable de conexión equipotencial
80-181-02-04	2	Beamer-Handgriff	Beamer handle	Mango Beamer
80-181-10-04	2	Beamer-Elektrode	Beamer electrode	Electrodo Beamer
80-181-13-04	2	Beamer-Lanzettelektrode	Beamer lancet electrode	Electrodo de lanceta Beamer
80-181-15-04	2	Beamer-Nadelelektrode	Beamer needle electrode	Electrodo de aguja Beamer
80-344-09-04	1*	PCS-DuoSafe-Einmal-Neutralelektroden	Disposable DuoSafe neutral electrodes	Placas neutras desechables PCS DuoSafe
80-294-40-04	1	Anschlusskabel für Neutralelektroden	Connection cable for neutral electrodes	Cable de conexión para placas neutras
80-924-16-04	2	Bipolare Pinzette, gerade, stumpf	Bipolar forceps, straight, blunt	Pinzas bipolares, rectas, romas
80-287-89-04	4	Anschlusskabel für bipolare Instrumente	Connection cable for bipolar instruments	Cable de conexión para instrumentos bipolares
		<b>Optional:</b>	<b>Optional:</b>	<b>Opcional:</b>
94-179-58-04	1	Gasflasche mit Füllung	Gas cylinder, filled	Botella de gas con relleno
80-047-00-04	1	maxium® Cart II	maxium® Cart II	maxium® Cart II
80-971-23-04	2	marClamp®, gebogene Version, 23 cm	marClamp®, curved version, 23 cm	marClamp®, versión curva, 23 cm
80-570-23-04	2	marCut®, 23 cm	marCut®, 23 cm	marCut®, 23 cm

\* VE = 50 Stck.

\* SU = 50/pack

\* UV = 50 piezas



<b>80-042-11-04</b>		<b>Lot d'accessoires pour maXium® m, composé de:</b>	<b>Accessory set for maXium® m, consisting of:</b>
80-181-52-04	1	Décompresseur (D, A, ...)	Riduttore di pressione (D, A, ...)
80-811-30-04	1	Interrupteur à pédale double	Interruttore a doppio pedale
80-811-50-04	1	Interrupteur à pédale	Interruttore a pedale
80-260-50-04	1	Câble de compensation de potentiel	Cavo per collegamento equipotenziale
80-181-02-04	2	Manche Beamer	Manico Beamer
80-181-10-04	2	Electrode Beamer	Elettrodo Beamer
80-181-13-04	2	Electrode lancette Beamer	Elettrodo a lancetta Beamer
80-181-15-04	2	Electrode aiguille Beamer	Elettrodo ad ago Beamer
80-344-09-04	1*	Electrodes neutres à usage unique type PCS DuoSafe	Elettrodi neutri PCS DuoSafe monouso
80-294-40-04	1	Câble de raccordement pour électrodes neutres	Cavo di connessione per elettrodi neutri
80-924-16-04	2	Pinces bipolaires, droites, mousses	Pinze bipolari, strette, smusse
80-287-33-04	4	Câble de raccordement pour instruments bipolaires	Cavo di connessione per strumenti bipolari
		<b>En option:</b>	<b>Opzioni:</b>
94-179-58-04	1	Bouteille de gaz avec remplissage	Bottiglia di gas con riempitura
80-047-00-04	1	maxium® Cart II	maxium® Cart II
80-971-23-04	2	marClamp®, version courbe, 23 cm	marClamp®, versione curva, 23 cm
80-570-23-04	2	marCut®, 23 cm	marCut®, 23 cm

<b>80-042-21-04</b>		<b>Lot d'accessoires pour maXium® i, composé de:</b>	<b>Accessory set for maXium® i, consisting of:</b>
80-181-53-04	1	Décompresseur (NL, DK, ...)	Riduttore di pressione (NL, DK, ...)
80-811-30-04	1	Interrupteur à pédale double	Interruttore a doppio pedale
80-811-50-04	1	Interrupteur à pédale	Interruttore a pedale
80-260-50-04	1	Câble de compensation de potentiel	Cavo per collegamento equipotenziale
80-181-02-04	2	Manche Beamer	Manico Beamer
80-181-10-04	2	Electrode Beamer	Elettrodo Beamer
80-181-13-04	2	Electrode lancette Beamer	Elettrodo a lancetta Beamer
80-181-15-04	2	Electrode aiguille Beamer	Elettrodo ad ago Beamer
80-344-09-04	1*	Electrodes neutres à usage unique type PCS DuoSafe	Elettrodi neutri PCS DuoSafe monouso
80-294-44-04	1	Câble de raccordement pour électrodes neutres	Cavo di connessione per elettrodi neutri
80-924-16-04	2	Pinces bipolaires, droites, mousses	Pinze bipolari, strette, smusse
80-287-89-04	4	Câble de raccordement pour instruments bipolaires	Cavo di connessione per strumenti bipolari
		<b>En option:</b>	<b>Opzioni:</b>
94-179-58-04	1	Bouteille de gaz avec remplissage	Bottiglia di gas con riempitura
80-047-00-04	1	maxium® Cart II	maxium® Cart II
80-971-23-04	2	marClamp®, version courbe, 23 cm	marClamp®, versione curva, 23 cm
80-570-23-04	2	marCut®, 23 cm	marCut®, 23 cm

<b>80-042-41-04</b>		<b>Lot d'accessoires pour maXium® e, composé de:</b>	<b>Accessory set for maXium® e, consisting of:</b>
80-181-55-04	1	Décompresseur (UK ...)	Riduttore di pressione (UK ...)
80-811-30-04	1	Interrupteur à pédale double	Interruttore a doppio pedale
80-811-50-04	1	Interrupteur à pédale	Interruttore a pedale
80-260-50-04	1	Câble de compensation de potentiel	Cavo per collegamento equipotenziale
80-181-02-04	2	Manche Beamer	Manico Beamer
80-181-10-04	2	Electrode Beamer	Elettrodo Beamer
80-181-13-04	2	Electrode lancette Beamer	Elettrodo a lancetta Beamer
80-181-15-04	2	Electrode aiguille Beamer	Elettrodo ad ago Beamer
80-344-09-04	1*	Electrodes neutres à usage unique type PCS DuoSafe	Elettrodi neutri PCS DuoSafe monouso
80-294-40-04	1	Câble de raccordement pour électrodes neutres	Cavo di connessione per elettrodi neutri
80-924-16-04	2	Pinces bipolaires, droites, mousses	Pinze bipolari, strette, smusse
80-287-89-04	4	Câble de raccordement pour instruments bipolaires	Cavo di connessione per strumenti bipolari
		<b>En option:</b>	<b>Opzioni:</b>
94-179-58-04	1	Bouteille de gaz avec remplissage	Bottiglia di gas con riempitura
80-047-00-04	1	maxium® Cart II	maxium® Cart II
80-971-23-04	2	marClamp®, version courbe, 23 cm	marClamp®, versione curva, 23 cm
80-570-23-04	2	marCut®, 23 cm	marCut®, 23 cm

\* UC = 50 pièces

\* UV = 50 pezzi

maxium®-Beamer-Zubehörsätze für die Endoskopische Chirurgie  
maxium® Beamer accessory sets for endoscopic surgery  
Juegos de accesorios maxium® Beamer para la cirugía endoscópica  
Jeux d'accessoires maxium® Beamer pour la chirurgie endoscopique  
Serie di accessori maxium® Beamer per la chirurgia endoscopica

80-042-12-04		Satz Zubehör für maXium® m, bestehend aus:	Accessory set for maXium® m, consisting of:	Juego de accesorios para maXium® m, compuesto de:
80-181-52-04	1	Druckminderer (D, A, ...)	Pressure reducer (D, A, ...)	Manorreductor (D, A, ...)
80-811-50-04	1	Einpedal-Fußschalter	Foot switch	Interrupor de pie
80-260-50-04	1	Potentialausgleichskabel	Potential equalization cable	Cable de conexión equipotencial
80-181-30-04	2	Beamer-Anschlusskabel	Beamer connection cable	Cable de conexión Beamer
80-181-24-04	2	GIT-Sonde ( Ø 3,2 mm)	GIT probe ( Ø 3.2 mm)	Sonda GIT ( Ø 3,2 mm)
80-181-23-04	2	GIT-Sonde ( Ø 2,3 mm)	GIT probe ( Ø 2.3 mm)	Sonda GIT ( Ø 2,3 mm)
80-181-25-04	2	TBS-Sonde ( Ø 1,5 mm)	TBS probe ( Ø 1.5 mm)	Sonda TBS ( Ø 1,5 mm)
80-344-09-04	1*	PCS-DuoSafe-Einmal-Neutralelektroden	Disposable DuoSafe neutral electrodes	Placas neutras desechables PCS DuoSafe
80-294-40-04	1	Anschlusskabel für Neutralelektroden	Connection cable for neutral electrodes	Cable de conexión para placas neutras
80-924-16-04	2	Bipolare Pinzette, gerade, stumpf	Bipolar forceps, straight, blunt	Pinzas bipolares, rectas, romas
80-287-33-04	4	Anschlusskabel für bipolare Instrumente	Connection cable for bipolar instruments	Cable de conexión para instrumentos bipolares
80-289-40-04	2	Olympus-Anschlusskabel	Olympus connection cable	Cable de conexión Olympus
		<b>Optional:</b>	<b>Optional:</b>	<b>Opcional:</b>
94-179-58-04	1	Gasflasche mit Füllung	Gas cylinder, filled	Botella de gas con relleno
80-047-00-04	1	maxium® Cart II	maxium® Cart II	maxium® Cart II

80-042-22-04		Satz Zubehör für maXium® i, bestehend aus:	Accessory set for maXium® i, consisting of:	Juego de accesorios para maXium® i, compuesto de:
80-181-53-04	1	Druckminderer (NL, DK, ...)	Pressure reducer (NL, DK, ...)	Manorreductor (NL, DK, ...)
80-811-50-04	1	Einpedal-Fußschalter	Foot switch	Interrupor de pie
80-260-50-04	1	Potentialausgleichskabel	Potential equalization cable	Cable de conexión equipotencial
80-181-30-04	2	Beamer-Anschlusskabel	Beamer connection cable	Cable de conexión Beamer
80-181-24-04	2	GIT-Sonde ( Ø 3,2 mm)	GIT probe ( Ø 3.2 mm)	Sonda GIT ( Ø 3,2 mm)
80-181-23-04	2	GIT-Sonde ( Ø 2,3 mm)	GIT probe ( Ø 2.3 mm)	Sonda GIT ( Ø 2,3 mm)
80-181-25-04	2	TBS-Sonde ( Ø 1,5 mm)	TBS probe ( Ø 1.5 mm)	Sonda TBS ( Ø 1,5 mm)
80-344-09-04	1*	PCS-DuoSafe-Einmal-Neutralelektroden	Disposable DuoSafe neutral electrodes	Placas neutras desechables PCS DuoSafe
80-294-44-04	1	Anschlusskabel für Neutralelektroden	Connection cable for neutral electrodes	Cable de conexión para placas neutras
80-924-16-04	2	Bipolare Pinzette, gerade, stumpf	Bipolar forceps, straight, blunt	Pinzas bipolares, rectas, romas
80-287-89-04	4	Anschlusskabel für bipolare Instrumente	Connection cable for bipolar instruments	Cable de conexión para instrumentos bipolares
80-289-40-04	2	Olympus-Anschlusskabel	Olympus connection cable	Cable de conexión Olympus
		<b>Optional:</b>	<b>Optional:</b>	<b>Opcional:</b>
94-179-58-04	1	Gasflasche mit Füllung	Gas cylinder, filled	Botella de gas con relleno
80-047-00-04	1	maxium® Cart II	maxium® Cart II	maxium® Cart II

80-042-42-04		Satz Zubehör für maXium® e, bestehend aus:	Accessory set for maXium® e, consisting of:	Juego de accesorios para maXium® e, compuesto de:
80-181-55-04	1	Druckminderer (UK...)	Pressure reducer (UK...)	Manorreductor (UK...)
80-811-50-04	1	Einpedal-Fußschalter	Foot switch	Interrupor de pie
80-260-50-04	1	Potentialausgleichskabel	Potential equalization cable	Cable de conexión equipotencial
80-181-30-04	2	Beamer-Anschlusskabel	Beamer connection cable	Cable de conexión Beamer
80-181-24-04	2	GIT-Sonde ( Ø 3,2 mm)	GIT probe ( Ø 3.2 mm)	Sonda GIT ( Ø 3,2 mm)
80-181-23-04	2	GIT-Sonde ( Ø 2,3 mm)	GIT probe ( Ø 2.3 mm)	Sonda GIT ( Ø 2,3 mm)
80-181-25-04	2	TBS-Sonde ( Ø 1,5 mm)	TBS probe ( Ø 1.5 mm)	Sonda TBS ( Ø 1,5 mm)
80-344-09-04	1*	PCS-DuoSafe-Einmal-Neutralelektroden	Disposable DuoSafe neutral electrodes	Placas neutras desechables PCS DuoSafe
80-294-40-04	1	Anschlusskabel für Neutralelektroden	Connection cable for neutral electrodes	Cable de conexión para placas neutras
80-924-16-04	2	Bipolare Pinzette, gerade, stumpf	Bipolar forceps, straight, blunt	Pinzas bipolares, rectas, romas
80-287-89-04	4	Anschlusskabel für bipolare Instrumente	Connection cable for bipolar instruments	Cable de conexión para instrumentos bipolares
80-289-40-04	2	Olympus-Anschlusskabel	Olympus connection cable	Cable de conexión Olympus
		<b>Optional:</b>	<b>Optional:</b>	<b>Opcional:</b>
94-179-58-04	1	Gasflasche mit Füllung	Gas cylinder, filled	Botella de gas con relleno
80-047-00-04	1	maxium® Cart II	maxium® Cart II	maxium® Cart II

\* VE = 50 Stck.

\* SU = 50/pack

\* UV = 50 piezas





80-042-12-04		Lot d'accessoires pour maXium® m, composé de:	Accessory set for maXium® m, consisting of:
80-181-52-04	1	Décompresseur (D, A, ...)	Riduttore di pressione (D, A, ...)
80-811-50-04	1	Interrupteur à pédale	Interruttore a pedale
80-260-50-04	1	Câble de compensation de potentiel	Cavo per collegamento equipotenziale
80-181-30-04	2	Câble de raccordement Beamer	Cavo di connessione Beamer
80-181-24-04	2	Sonde GIT ( Ø 3,2 mm)	Sonda GIT ( Ø 3,2 mm)
80-181-23-04	2	Sonde GIT ( Ø 2,3 mm)	Sonda GIT ( Ø 2,3 mm)
80-181-25-04	2	Sonde TBS ( Ø 1,5 mm)	Sonda TBS ( Ø 1,5 mm)
80-344-09-04	1*	Electrodes neutres à usage unique type PCS DuoSafe	Elettrodi neutri PCS DuoSafe monouso
80-294-40-04	1	Câble de raccordement pour électrodes neutres	Cavo di connessione per elettrodi neutri
80-924-16-04	2	Pincés bipolaires, droites, mousses	Pinze bipolari, strette, smusse
80-287-33-04	4	Câble de raccordement pour instruments bipolaires	Cavo di connessione per strumenti bipolari
80-289-40-04	2	Câble de raccordement Olympus	Cavo di connessione Olympus
		<b>En option:</b>	<b>Opzioni:</b>
94-179-58-04	1	Bouteille de gaz avec remplissage	Bottiglia di gas con riempitura
80-047-00-04	1	maxium® Cart II	maxium® Cart II

80-042-22-04		Lot d'accessoires pour maXium® i, composé de:	Accessory set for maXium® i, consisting of:
80-181-53-04	1	Décompresseur (NL, DK, ...)	Riduttore di pressione (NL, DK, ...)
80-811-50-04	1	Interrupteur à pédale	Interruttore a pedale
80-260-50-04	1	Câble de compensation de potentiel	Cavo per collegamento equipotenziale
80-181-30-04	2	Câble de raccordement Beamer	Cavo di connessione Beamer
80-181-24-04	2	Sonde GIT ( Ø 3,2 mm)	Sonda GIT ( Ø 3,2 mm)
80-181-23-04	2	Sonde GIT ( Ø 2,3 mm)	Sonda GIT ( Ø 2,3 mm)
80-181-25-04	2	Sonde TBS ( Ø 1,5 mm)	Sonda TBS ( Ø 1,5 mm)
80-344-09-04	1*	Electrodes neutres à usage unique type PCS DuoSafe	Elettrodi neutri PCS DuoSafe monouso
80-294-44-04	1	Câble de raccordement pour électrodes neutres	Cavo di connessione per elettrodi neutri
80-924-16-04	2	Pincés bipolaires, droites, mousses	Pinze bipolari, strette, smusse
80-287-89-04	4	Câble de raccordement pour instruments bipolaires	Cavo di connessione per strumenti bipolari
80-289-40-04	2	Câble de raccordement Olympus	Cavo di connessione Olympus
		<b>En option:</b>	<b>Opzioni:</b>
94-179-58-04	1	Bouteille de gaz avec remplissage	Bottiglia di gas con riempitura
80-047-00-04	1	maxium® Cart II	maxium® Cart II

80-042-42-04		Lot d'accessoires pour maXium® e, composé de:	Accessory set for maXium® e, consisting of:
80-181-55-04	1	Décompresseur (UK...)	Riduttore di pressione (UK...)
80-811-50-04	1	Interrupteur à pédale	Interruttore a pedale
80-260-50-04	1	Câble de compensation de potentiel	Cavo per collegamento equipotenziale
80-181-30-04	2	Câble de raccordement Beamer	Cavo di connessione Beamer
80-181-24-04	2	Sonde GIT ( Ø 3,2 mm)	Sonda GIT ( Ø 3,2 mm)
80-181-23-04	2	Sonde GIT ( Ø 2,3 mm)	Sonda GIT ( Ø 2,3 mm)
80-181-25-04	2	Sonde TBS ( Ø 1,5 mm)	Sonda TBS ( Ø 1,5 mm)
80-344-09-04	1*	Electrodes neutres à usage unique type PCS DuoSafe	Elettrodi neutri PCS DuoSafe monouso
80-294-40-04	1	Câble de raccordement pour électrodes neutres	Cavo di connessione per elettrodi neutri
80-924-16-04	2	Pincés bipolaires, droites, mousses	Pinze bipolari, strette, smusse
80-287-89-04	4	Câble de raccordement pour instruments bipolaires	Cavo di connessione per strumenti bipolari
80-289-40-04	2	Câble de raccordement Olympus	Cavo di connessione Olympus
		<b>En option:</b>	<b>Opzioni:</b>
94-179-58-04	1	Bouteille de gaz avec remplissage	Bottiglia di gas con riempitura
80-047-00-04	1	maxium® Cart II	maxium® Cart II

\* UC = 50 pièces

\* UV = 50 pezzi

Zubehörsätze für Kleingeräte  
 Accessory sets for minor electrosurgical units  
 Juegos de accesorios para aparatos pequeños  
 Jeux d'accessoires pour petits appareils  
 Serie di accessori per apparecchi piccoli

80-107-00-04		Satz Zubehör MD 62 Hand, bestehend aus:	Accessory set for MD 62 for hand switch operation, consisting of:	Juego de accesorios MD 62 con interruptor digital, compuesto de:
80-214-11-04	1	Handgriff mit Fingerschalter, 3 m Kabel	- Electrode handle with finger switch and connection cable of 3 m	- Mango porta-electrodos con interruptor y cable de conexión de 3 m
80-444-08-01	1	Elektroden-Ständer für 8 Dentalelektroden	- Electrode box for 8 dental electrodes	- Caja para 8 electrodos dentales
80-461-01-04	1	Nadelelektrode	- Needle electrode	- Electrodo de aguja
80-461-02-04	1	Nadelelektrode	- Needle electrode	- Electrodo de aguja
80-461-12-04	1	Schlingenelektrode	- Loop electrode	- Electrodo de asa de alambre
80-461-14-04	1	Schlingenelektrode	- Loop electrode	- Electrodo de asa de alambre
80-461-15-04	1	Schlingenelektrode	- Loop electrode	- Electrodo de asa de alambre
80-461-31-04	1	Koagulations-Nadelelektrode	- Coagulation needle electrode	- Electrodo de aguja, para la coagulación
80-461-34-04	1	Koagulations-Kugelelektrode	- Coagulation ball electrode	- Electrodo de bola, para la coagulación
80-310-04-04	1	Handzylinder-Neutralelektrode mit 4 m Kabel	- Hand cylinder neutral electrode with connection cable of 4 m	- Placa neutra en forma de cilindro con cable de conexión de 4 m

80-106-01-04		Satz Zubehör MD 62 Fuß, bestehend aus:	Accessory set for MD 62 for foot switch operation, consisting of:	Juego de accesorios MD 62 con interruptor de pedal, compuesto de:
80-214-10-04	1	Handgriff ohne Schalter, 3 m Kabel	- Electrode handle without switch, with connection cable of 3 m	- Mango porta-electrodos sin interruptor, con cable de conexión de 3 m
80-444-08-01	1	Elektroden-Ständer für 8 Dentalelektroden	- Electrode box for 8 dental electrodes	- Caja para 8 electrodos dentales
80-461-01-04	1	Nadelelektrode	- Needle electrode	- Electrodo de aguja
80-461-02-04	1	Nadelelektrode	- Needle electrode	- Electrodo de aguja
80-461-12-04	1	Schlingenelektrode	- Loop electrode	- Electrodo de asa de alambre
80-461-14-04	1	Schlingenelektrode	- Loop electrode	- Electrodo de asa de alambre
80-461-15-04	1	Schlingenelektrode	- Loop electrode	- Electrodo de asa de alambre
80-461-31-04	1	Koagulations-Nadelelektrode	- Coagulation needle electrode	- Electrodo de aguja, para la coagulación
80-461-34-04	1	Koagulations-Kugelelektrode	- Coagulation ball electrode	- Electrodo de bola, para la coagulación
80-812-10-04	1	Einpedal-Fußschalter, Air, 3 m Kabel	- Single-pedal foot switch, Air, with connection cable of 3 m	- Interruptor de pedal, Air, cable de conexión de 3 m
80-310-04-04	1	Handzylinder-Neutralelektrode mit 4 m Kabel	- Hand cylinder neutral electrode with connection cable of 4 m	- Placa neutra en forma de cilindro con cable de conexión de 4 m

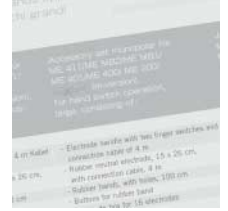

<b>80-107-00-04</b>		<b>Lot d'accessoires MD 62 pour commande digitale, composé de:</b>	<b>Serie di accessori standard MD 62, per attivazione a mano, composta di:</b>
80-214-11-04	1	Manche porte-électrode avec interrupteur et câble de raccordement de 3 m	- Manico portaelettrodi con interruttore e cavo di connessione di 3 m
80-444-08-01	1	Boîte pour 8 électrodes dentaires	- Supporto per 8 elettrodi dentali in scatola
80-461-01-04	1	Electrode aiguille	- Elettrodo ad ago
80-461-02-04	1	Electrode aiguille	- Elettrodo ad ago
80-461-12-04	1	Electrode anse	- Elettrodo ad ansa
80-461-14-04	1	Electrode anse	- Elettrodo ad ansa
80-461-15-04	1	Electrode anse	- Elettrodo ad ansa
80-461-31-04	1	Electrode aiguille pour la coagulation	- Elettrodo ad ago per coagulazione
80-461-34-04	1	Electrode boule pour la coagulation	- Elettrodo a sfera per coagulazione
80-310-04-04	1	Electrode neutre en forme de cylindre avec câble de raccordement de 4 m	- Elettrodo neutro a forma cilindrica con cavo di connessione da 4 m

<b>80-106-01-04</b>		<b>Lot d'accessoires MD 62 pour commande par pédale, composé de:</b>	<b>Serie di accessori standard MD 62, per attivazione a pedale, composta di:</b>
80-214-10-04	1	Manche porte-électrode sans interrupteur, avec câble de raccordement de 3 m	- Manico portaelettrodi senza interruttore, con cavo di connessione di 3 m
80-444-08-01	1	Boîte pour 8 électrodes dentaires	- Supporto per 8 elettrodi dentali in scatola
80-461-01-04	1	Electrode aiguille	- Elettrodo ad ago
80-461-02-04	1	Electrode aiguille	- Elettrodo ad ago
80-461-12-04	1	Electrode anse	- Elettrodo ad ansa
80-461-14-04	1	Electrode anse	- Elettrodo ad ansa
80-461-15-04	1	Electrode anse	- Elettrodo ad ansa
80-461-31-04	1	Electrode aiguille pour la coagulation	- Elettrodo ad ago per coagulazione
80-461-34-04	1	Electrode boule pour la coagulation	- Elettrodo a sfera per coagulazione
80-812-10-04	1	Interrupteur à pédale, Air, avec câble de raccordement de 3 m	- Interruttore con 1 pedale, Air, con cavo di connessione di 3 m
80-310-04-04	1	Electrode neutre en forme de cylindre avec câble de raccordement de 4 m	- Elettrodo neutro a forma cilindrica con cavo di connessione da 4 m

Zubehörsätze für Kleingeräte  
 Accessory sets for minor electrosurgical units  
 Juegos de accesorios para aparatos pequeños  
 Jeux d'accessoires pour petits appareils  
 Serie di accessori per apparecchi piccoli

80-108-03-04		Satz monopolares Zubehör ME 82/Minicutter, Hand, groß, bestehend aus:	Accessory set monopolar for ME 82/Minicutter for hand switch operation, large, consisting of:	Juego de accesorios monopolares ME 82/ Minicutter con interruptor digital, grande, compuesto de:
80-217-01-04	1	Handgriff mit einer Taste, 4 m Kabel	- Electrode handle with one pushbutton and connection cable of 4 m	- Mango porta-electrodos con una tecla y cable de conexión de 4 m
80-332-03-04	1	Gummi-Neutralelektrode 8 x 16 cm, 4 m Kabel	- Rubber neutral electrode, 8 x 16 cm, with connection cable of 4 m	- Placa neutra de goma, 8 x 16 cm, cable de conexión de 4 m
80-370-50-04	1	Gummibinde, gelocht, 50 cm	- Rubber band, with holes, 50 cm	- Cinta de goma, perforada, 50 cm
80-371-01-04	1	Knopf für Gummibinde	- Button for rubber band	- Botón para la cinta de goma
80-408-00-04	1	Elektroden-Ständer für 8 Elektroden	- Electrode box for 8 electrodes	- Caja para 8 electrodos
80-505-00-04	1*	Reinigungspad für Elektroden, steril verpackt	- Cleaning pad for electrodes, sterile packed	- Almohadilla de limpieza para electrodos, embalado estéril
80-510-04-04	1	Lanzettelektrode, gerade	- Lancet electrode, straight	- Electrodo de lanceta, recto
80-515-04-04	1	Messerelektrode	- Knife electrode	- Electrodo de cuchillo
80-520-04-04	1	Nadelelektrode	- Needle electrode	- Electrodo de aguja
80-525-04-04	1	Dtz. Nadelelektroden, extra fein	- Doz. needle electrodes, extra fine	- Docena de electrodos de aguja, especialmente finos
80-532-00-04	1	Reduz.-Stück für Nadelelektroden	- Adapter for needle electrodes	- Adaptador para electrodos de aguja
80-540-04-04	1	Drahtschlingenelektrode, Ø 5 mm	- Wire loop electrode, Ø 5 mm	- Electrodo de asa de alambre, Ø 5 mm
80-542-04-04	1	Drahtschlingenelektrode, Ø 10 mm	- Wire loop electrode, Ø 10 mm	- Electrodo de asa de alambre, Ø 10 mm
80-560-04-04	1	Kugelelektrode, Ø 2 mm	- Ball electrode, Ø 2 mm	- Electrodo de bola, Ø 2 mm
80-562-04-04	1	Kugelelektrode, Ø 4 mm	- Ball electrode, Ø 4 mm	- Electrodo de bola, Ø 4 mm

80-108-04-04		Satz monopolares Zubehör ME 82/Minicutter, Fuß, groß, bestehend aus:	Accessory set monopolar for ME 82/Minicutter for foot switch operation, large, consisting of:	Juego de accesorios monopolares ME 82/Minicutter con interruptor de pedal, grande, compuesto de:
80-220-00-04	1	Handgriff ohne Schalter, 4 m Kabel	- Electrode handle with one pushbutton and connection cable of 4 m	- Mango porta-electrodos con una tecla y cable de conexión de 4 m
80-332-03-04	1	Gummi-Neutralelektrode 8 x 16 cm, 4 m Kabel	- Rubber neutral electrode, 8 x 16 cm, with connection cable of 4 m	- Placa neutra de goma, 8 x 16 cm, cable de conexión de 4 m
80-370-50-04	1	Gummibinde, gelocht, 50 cm	- Rubber band, with holes, 50 cm	- Cinta de goma, perforada, 50 cm
80-371-01-04	1	Knopf für Gummibinde	- Button for rubber band	- Botón para la cinta de goma
80-408-00-01	1	Elektroden-Ständer für 8 Elektroden	- Electrode box for 8 electrodes	- Caja para 8 electrodos
80-505-00-04	1*	Reinigungspad für Elektroden, steril verpackt	- Cleaning pad for electrodes, sterile packed	- Almohadilla de limpieza para electrodos, embalado estéril
80-510-04-04	1	Lanzettelektrode, gerade	- Lancet electrode, straight	- Electrodo de lanceta, recto
80-515-04-04	1	Messerelektrode	- Knife electrode	- Electrodo de cuchillo
80-520-04-04	1	Nadelelektrode	- Needle electrode	- Electrodo de aguja
80-525-04-04	1	Dtz. Nadelelektroden, extra fein	- Doz. needle electrodes, extra fine	- Docena de electrodos de aguja, especialmente finos
80-532-00-04	1	Reduz.-Stück für Nadelelektroden	- Adapter for needle electrodes	- Adaptador para electrodos de aguja
80-540-04-04	1	Drahtschlingenelektrode, Ø 5 mm	- Wire loop electrode, Ø 5 mm	- Electrodo de asa de alambre, Ø 5 mm
80-542-04-04	1	Drahtschlingenelektrode, Ø 10 mm	- Wire loop electrode, Ø 10 mm	- Electrodo de asa de alambre Ø 10 mm
80-560-04-04	1	Kugelelektrode, Ø 2 mm	- Ball electrode, Ø 2 mm	- Electrodo de bola, Ø 2 mm
80-562-04-04	1	Kugelelektrode, Ø 4 mm	- Ball electrode, Ø 4 mm	- Electrodo de bola, Ø 4 mm
80-811-50-04	1	Einpedal-Fußschalter, AP-geprüft, 5 m Kabel	- Foot switch, anti-explosive, with connection cable of 5 m	- Interruptor de pedal, anti-explosivo, con cable de conexión de 5 m

80-108-05-04		Satz monopolares Zubehör ME 82/Minicutter, Hand, klein, bestehend aus:	Accessory set monopolar for ME 82/Minicutter for hand switch operation, small, consisting of:	Juego de accesorios monopolares ME 82/Minicutter con interruptor digital, pequeño, compuesto de:
80-217-01-04	1	Handgriff mit einer Taste, 4 m Kabel	- Electrode handle with one pushbutton and connection cable of 4 m	- Mango porta-electrodos con una tecla y cable de conexión de 4 m
80-332-03-04	1	Gummi-Neutralelektrode 8 x 16 cm, 4 m Kabel	- Rubber neutral electrode, 8 x 16 cm, with connection cable of 4 m	- placa neutra de goma, 8 x 16 cm, cable de conexión de 4 m
80-372-00-04	1	Textilband mit Klettverschluss, 90 cm	- Textile band with velcro strap, 90 cm	- Tira auto-adhesiva, 90 cm
80-505-00-04	1*	Reinigungspad für Elektroden, steril verpackt	- Cleaning pad for electrodes, sterile packed	- Almohadilla de limpieza para electrodos, embalado estéril
80-511-04-04	1	Lanzettelektrode, abgewinkelt	- Lancet electrode, angled	- Electrodo de lanceta, acodado
80-515-04-04	1	Messerelektrode	- Knife electrode	- Electrodo de cuchillo
80-520-04-04	1	Nadelelektrode	- Needle electrode	- Electrodo de aguja
80-562-04-04	1	Kugelelektrode, Ø 4 mm	- Ball electrode, Ø 4 mm	- Electrodo de bola, Ø 4 mm

\* VE = 100 Stck.

\* SU = 100/pack

\* UV = 100 piezas



<b>80-108-03-04</b>		<b>Grand lot d'accessoires monopolaires ME 82/Minicutter pour commande digitale, composé de:</b>	<b>Serie grande di accessori monopolari standard ME 82/Minicutter, per attivazione a mano, composta di:</b>
80-217-01-04	1	Manche porte-électrode avec interrupteur digital et câble de raccordement de 4 m	- Manico portaelettrodi con interruttore e cavo di connessione di 4 m
80-332-03-04	1	Electrode neutre en caoutchouc, 8 x 16 cm, avec câble de raccordement de 4 m	- Elettrodo neutro di gomma, 8 x 16 cm, cavo di connessione di 4 m
80-370-50-04	1	Bande caoutchouc, perforée, 50 cm	- Nastro di gomma, perforato, 50 cm
80-371-01-04	1	Bouton pour bande caoutchouc	- Bottone per nastro di gomma
80-408-00-04	1	Boîte pour 8 électrodes	- Supporto per 8 elettrodi in scatola
80-505-00-04	1*	Tampon de nettoyage pour électrodes, emballage stérile	- Tampone di pulizia per elettrodi, imballaggio sterile
80-510-04-04	1	Electrode lancette, droite	- Elettrodo a lancetta, retto
80-515-04-04	1	Electrode couteau	- Elettrodo a bisturi
80-520-04-04	1	Electrode aiguille	- Elettrodo ad ago
80-525-04-04	1	Douz. d'électrodes aiguille, extra fines	- Elettrodo ad ago, strafino, dozz.
80-532-00-04	1	Adaptateur pour électrodes aiguille	- Adattatore per elettrodi ad ago
80-540-04-04	1	Electrode anse en fil, Ø 5 mm	- Elettrodo ad ansa, Ø 5 mm
80-542-04-04	1	Electrode anse en fil, Ø 10 mm	- Elettrodo ad ansa, Ø 10 mm
80-560-04-04	1	Electrode boule, Ø 2 mm	- Elettrodo a sfera, Ø 2 mm
80-562-04-04	1	Electrode boule, Ø 4 mm	- Elettrodo a sfera, Ø 4 mm

<b>80-108-04-04</b>		<b>Grand lot d'accessoires monopolaires ME 82/Minicutter pour commande par pédale, composé de:</b>	<b>Serie grande di accessori monopolari standard ME 82/Minicutter, per attivazione a pedale, composta di:</b>
80-220-00-04	1	Manche porte-électrode sans interrupteur, avec câble de raccordement de 4 m	- Manico portaelettrodi senza interruttore, con cavo di connessione di 4 m
80-332-03-04	1	Electrode neutre en caoutchouc, 8 x 16 cm, avec câble de raccordement de 4 m	- Elettrodo neutro di gomma, 8 x 16 cm, cavo di connessione di 4 m
80-370-50-04	1	Bande caoutchouc, perforée, 50 cm	- Nastro di gomma, perforato, 50 cm
80-371-01-04	1	Bouton pour bande caoutchouc	- Bottone per nastro di gomma
80-408-00-01	1	Boîte pour 8 électrodes	- Supporto per 8 elettrodi in scatola
80-505-00-04	1*	Tampon de nettoyage pour électrodes, emballage stérile	- Tampone di pulizia per elettrodi, imballaggio sterile
80-510-04-04	1	Electrode lancette, droite	- Elettrodo a lancetta, retto
80-515-04-04	1	Electrode couteau	- Elettrodo a bisturi
80-520-04-04	1	Electrode aiguille	- Elettrodo ad ago
80-525-04-04	1	Douz. d'électrodes aiguille, extra fines	- Elettrodo ad ago, strafino, dozz.
80-532-00-04	1	Adaptateur pour électrodes aiguille	- Adattatore per elettrodi ad ago
80-540-04-04	1	Electrode anse en fil, Ø 5 mm	- Elettrodo ad ansa, Ø 5 mm
80-542-04-04	1	Electrode anse en fil, Ø 10 mm	- Elettrodo ad ansa, Ø 10 mm
80-560-04-04	1	Electrode boule, Ø 2 mm	- Elettrodo a sfera, Ø 2 mm
80-562-04-04	1	Electrode boule, Ø 4 mm	- Elettrodo a sfera, Ø 4 mm
80-811-50-04	1	Interrupteur à pédale, anti-explosif avec câble de raccordement de 5 m	- Interruttore a pedale, anti-deflagrante, con cavo di connessione di 5 m

<b>80-108-05-04</b>		<b>Petit lot d'accessoires monopolaires ME 82/Minicutter pour commande digitale, composé de:</b>	<b>Serie piccola di accessori monopolari standard ME 82/Minicutter, per attivazione a mano, composta di:</b>
80-217-01-04	1	Manche porte-électrode avec interrupteur digital et câble de raccordement de 4 m	- Manico portaelettrodi con interruttore e cavo di connessione di 4 m
80-332-03-04	1	Electrode neutre en caoutchouc, 8 x 16 cm, avec câble de raccordement de 4 m	- Elettrodo neutro di gomma, 8 x 16 cm, cavo di connessione di 4 m
80-372-00-04	1	Bande auto-adhésive, 90 cm	- Nastro tessile auto-adesivo, 90 cm
80-505-00-04	1*	Tampon de nettoyage pour électrodes, emballage stérile	- Tampone di pulizia per elettrodi, imballaggio sterile
80-511-04-04	1	Electrode lancette, coudée	- Elettrodo a lancetta, angolato
80-515-04-04	1	Electrode couteau	- Elettrodo a bisturi
80-520-04-04	1	Electrode aiguille	- Elettrodo ad ago
80-562-04-04	1	Electrode boule, Ø 4 mm	- Elettrodo a sfera, Ø 4 mm

\* UC = 100 pièces

\* UV = 100 pezzi

Zubehörsätze für Kleingeräte  
 Accessory sets for minor electrosurgical units  
 Juegos de accesorios para aparatos pequeños  
 Jeux d'accessoires pour petits appareils  
 Serie di accessori per apparecchi piccoli

80-108-00-04		Satz monopoles Zubehör ME 81/ME 102, Hand, groß, bestehend aus:	Accessory set monopolar for ME 81/ME 102 for hand switch operation, large, consisting of:	Juego de accesorios monopoles ME 81/ME 102 con interruptor digital, grande, compuesto de:
80-217-02-04	1	Handgriff mit Doppelschalter, 4 m Kabel	- Electrode handle with two finger switches and connection cable of 4 m	- Mango porta-electrodos con interruptor digital doble y cable de conexión de 4 m
80-332-03-04	1	Gummi-Neutralelektrode 8 x 16 cm, 4 m Kabel	- Rubber neutral electrode, 8 x 16 cm, with connection cable of 4 m	- Placa neutra de goma, 8 x 16 cm, cable de conexión de 4 m
80-370-50-04	1	Gummibinde, gelocht, 50 cm	- Rubber band, with holes, 50 cm	- Cinta de goma, perforada, 50 cm
80-371-01-04	1	Knopf für Gummibinde	- Button for rubber band	- Botón para la cinta de goma
80-408-00-04	1	Elektroden-Ständer für 8 Elektroden	- Electrode box for 8 electrodes	- Caja para 8 electrodos
80-505-00-04	1*	Reinigungspad für Elektroden, steril verpackt	- Cleaning pad for electrodes, sterile packed	- Almohadilla de limpieza para electrodos, embalado estéril
80-510-04-04	1	Lanzettelektrode, gerade	- Lancet electrode, straight	- Electrodo de lanceta, recto
80-515-04-04	1	Messerelektrode	- Knife electrode	- Electrodo de cuchillo
80-520-04-04	1	Nadelelektrode	- Needle electrode	- Electrodo de aguja
80-525-04-04	1	Dtz. Nadelelektroden, extra fein	- Doz. needle electrodes, extra fine	- Docena de electrodos de aguja, especialmente finos
80-532-00-04	1	Reduz.-Stück für Nadelelektroden	- Adapter for needle electrodes	- Adaptador para electrodos de aguja
80-540-04-04	1	Drahtschlingenelektrode, Ø 5 mm	- Wire loop electrode, Ø 5 mm	- Electrodo de asa de alambre, Ø 5 mm
80-542-04-04	1	Drahtschlingenelektrode, Ø 10 mm	- Wire loop electrode, Ø 10 mm	- Electrodo de asa de alambre, Ø 10 mm
80-560-04-04	1	Kugelelektrode, Ø 2 mm	- Ball electrode, Ø 2 mm	- Electrodo de bola, Ø 2 mm
80-562-04-04	1	Kugelelektrode, Ø 4 mm	- Ball electrode, Ø 4 mm	- Electrodo de bola, Ø 4 mm

80-108-01-04		Satz monopoles Zubehör ME 81/ME 102, Fuß, groß, bestehend aus:	Accessory set monopolar for ME 81/ME 102 for foot switch operation, large, consisting of:	Juego de accesorios monopoles ME 81/ ME 102 con interruptor de pedal, grande, compuesto de:
80-220-00-04	1	Handgriff ohne Schalter, 4 m Kabel	- Electrode handle with one pushbutton and connection cable of 4 m	- Mango porta-electrodos con una tecla y cable de conexión de 4 m
80-332-03-04	1	Gummi-Neutralelektrode 8 x 16 cm, 4 m Kabel	- Rubber neutral electrode, 8 x 16 cm, with connection cable of 4 m	- Placa neutra de goma, 8 x 16 cm, cable de conexión de 4 m
80-370-50-04	1	Gummibinde, gelocht, 50 cm	- Rubber band, with holes, 50 cm	- Cinta de goma, perforada, 50 cm
80-371-01-04	1	Knopf für Gummibinde	- Button for rubber band	- Botón para la cinta de goma
80-408-00-01	1	Elektroden-Ständer für 8 Elektroden	- Electrode box for 8 electrodes	- Caja para 8 electrodos
80-505-00-04	1*	Reinigungspad für Elektroden, steril verpackt	- Cleaning pad for electrodes, sterile packed	- Almohadilla de limpieza para electrodos, embalado estéril
80-510-04-04	1	Lanzettelektrode, gerade	- Lancet electrode, straight	- Electrodo de lanceta, recto
80-515-04-04	1	Messerelektrode	- Knife electrode	- Electrodo de cuchillo
80-520-04-04	1	Nadelelektrode	- Needle electrode	- Electrodo de aguja
80-525-04-04	1	Dtz. Nadelelektroden, extra fein	- Doz. needle electrodes, extra fine	- Docena de electrodos de aguja, especialmente finos
80-532-00-04	1	Reduz.-Stück für Nadelelektroden	- Adapter for needle electrodes	- Adaptador para electrodos de aguja
80-540-04-04	1	Drahtschlingenelektrode, Ø 5 mm	- Wire loop electrode, Ø 5 mm	- Electrodo de asa de alambre, Ø 5 mm
80-542-04-04	1	Drahtschlingenelektrode, Ø 10 mm	- Wire loop electrode, Ø 10 mm	- Electrodo de asa de alambre, Ø 10 mm
80-560-04-04	1	Kugelelektrode, Ø 2 mm	- Ball electrode, Ø 2 mm	- Electrodo de bola, Ø 2 mm
80-562-04-04	1	Kugelelektrode, Ø 4 mm	- Ball electrode, Ø 4 mm	- Electrodo de bola, Ø 4 mm
80-823-02-04	1	Doppelpedal-Fußschalter, 5 m Kabel	- Double-pedal foot switch, with connection cable of 5 m	- Interruptor de pedal, anti-explosivo, con cable de conexión de 5 m

80-108-02-04		Satz monopoles Zubehör ME 81/ME 102, Hand, klein, bestehend aus:	Accessory set monopolar for ME 81/ME 102 for hand switch operation, small, consisting of:	Juego de accesorios monopoles ME 81/ME 102 con interruptor digital, pequeño, compuesto de:
80-217-01-04	1	Handgriff mit einer Taste, 4 m Kabel	- Electrode handle with one pushbutton and connection cable of 4 m	- Mango porta-electrodos con una tecla y cable de conexión de 4 m
80-332-03-04	1	Gummi-Neutralelektrode 8 x 16 cm, 4 m Kabel	- Rubber neutral electrode, 8 x 16 cm, with connection cable of 4 m	- placa neutra de goma, 8 x 16 cm, cable de conexión de 4 m
80-372-00-04	1	Textilband mit Klettverschluss, 90 cm	- Textile band with velcro strap, 90 cm	- Tira auto-adhesiva, 90 cm
80-505-00-04	1*	Reinigungspad für Elektroden, steril verpackt	- Cleaning pad for electrodes, sterile packed	- Almohadilla de limpieza para electrodos, embalado estéril
80-511-04-04	1	Lanzettelektrode, abgewinkelt	- Lancet electrode, angled	- Electrodo de lanceta, acodado
80-515-04-04	1	Messerelektrode	- Knife electrode	- Electrodo de cuchillo
80-520-04-04	1	Nadelelektrode	- Needle electrode	- Electrodo de aguja
80-562-04-04	1	Kugelelektrode, Ø 4 mm	- Ball electrode, Ø 4 mm	- Electrodo de bola, Ø 4 mm

\* VE = 100 Stck.

\* SU = 100/pack

\* UV = 100 piezas

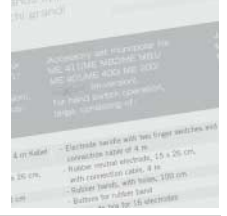

<b>80-108-00-04</b>		<b>Grand lot d'accessoires monopolaires ME 81/ME 102 pour commande digitale, composé de:</b>	<b>Serie grande di accessori monopolari standard ME 81/ME 102, per attivazione a mano, composta di:</b>
80-217-02-04	1	Manche porte-électrode avec interrupteur digital double et câble de raccordement de 4 m	- Manico portaelettrodi con interruttore doppio e cavo di connessione di 4 m
80-332-03-04	1	Electrode neutre en caoutchouc, 8 x 16 cm, avec câble de raccordement de 4 m	- Elettrodo neutro di gomma, 8 x 16 cm, cavo di connessione di 4 m
80-370-50-04	1	Bande caoutchouc, perforée, 50 cm	- Nastro di gomma, perforato, 50 cm
80-371-01-04	1	Bouton pour bande caoutchouc	- Bottone per nastro di gomma
80-408-00-04	1	Boîte pour 8 électrodes	- Supporto per 8 elettrodi in scatola
80-505-00-04	1*	Tampon de nettoyage pour électrodes, emballage stérile	- Tampone di pulizia per elettrodi, imballaggio sterile
80-510-04-04	1	Electrode lancette, droite	- Elettrodo a lancetta, retto
80-515-04-04	1	Electrode couteau	- Elettrodo a bisturi
80-520-04-04	1	Electrode aiguille	- Elettrodo ad ago
80-525-04-04	1	Douz. d'électrodes aiguille, extra fines	- Elettrodo ad ago, strafino, dozz.
80-532-00-04	1	Adaptateur pour électrodes aiguille	- Adattatore per elettrodi ad ago
80-540-04-04	1	Electrode anse en fil, Ø 5 mm	- Elettrodo ad ansa, Ø 5 mm
80-542-04-04	1	Electrode anse en fil, Ø 10 mm	- Elettrodo ad ansa, Ø 10 mm
80-560-04-04	1	Electrode boule, Ø 2 mm	- Elettrodo a sfera, Ø 2 mm
80-562-04-04	1	Electrode boule, Ø 4 mm	- Elettrodo a sfera, Ø 4 mm

<b>80-108-01-04</b>		<b>Grand lot d'accessoires monopolaires ME 81/ME 102 pour commande par pédale, composé de:</b>	<b>Serie grande di accessori monopolari standard ME 81/ME 102, per attivazione a pedale, composta di:</b>
80-220-00-04	1	Manche porte-électrode sans interrupteur, avec câble de raccordement de 4 m	- Manico portaelettrodi senza interruttore, con cavo di connessione di 4 m
80-332-03-04	1	Electrode neutre en caoutchouc, 8 x 16 cm, avec câble de raccordement de 4 m	- Elettrodo neutro di gomma, 8 x 16 cm, cavo di connessione di 4 m
80-370-50-04	1	Bande caoutchouc, perforée, 50 cm	- Nastro di gomma, perforato, 50 cm
80-371-01-04	1	Bouton pour bande caoutchouc	- Bottone per nastro di gomma
80-408-00-01	1	Boîte pour 8 électrodes	- Supporto per 8 elettrodi in scatola
80-505-00-04	1*	Tampon de nettoyage pour électrodes, emballage stérile	- Tampone di pulizia per elettrodi, imballaggio sterile
80-510-04-04	1	Electrode lancette, droite	- Elettrodo a lancetta, retto
80-515-04-04	1	Electrode couteau	- Elettrodo a bisturi
80-520-04-04	1	Electrode aiguille	- Elettrodo ad ago
80-525-04-04	1	Douz. d'électrodes aiguille, extra fines	- Elettrodo ad ago, strafino, dozz.
80-532-00-04	1	Adaptateur pour électrodes aiguille	- Adattatore per elettrodi ad ago
80-540-04-04	1	Electrode anse en fil, Ø 5 mm	- Elettrodo ad ansa, Ø 5 mm
80-542-04-04	1	Electrode anse en fil, Ø 10 mm	- Elettrodo ad ansa, Ø 10 mm
80-560-04-04	1	Electrode boule, Ø 2 mm	- Elettrodo a sfera, Ø 2 mm
80-562-04-04	1	Electrode boule, Ø 4 mm	- Elettrodo a sfera, Ø 4 mm
80-823-02-04	1	Interrupteur à pédale double, avec câble de raccordement de 5 m	- Interruttore a pedale doppio, con cavo di connessione di 5 m

<b>80-108-02-04</b>		<b>Petit lot d'accessoires monopolaires ME 81/ME 102 pour commande digitale, composé de:</b>	<b>Serie piccola di accessori monopolari standard ME 81/ME 102, per attivazione a mano, composta di:</b>
80-217-01-04	1	Manche porte-électrode avec interrupteur digital et câble de raccordement de 4 m	- Manico portaelettrodi con interruttore e cavo di connessione di 4 m
80-332-03-04	1	Electrode neutre en caoutchouc, 8 x 16 cm, avec câble de raccordement de 4 m	- Elettrodo neutro di gomma, 8 x 16 cm, cavo di connessione di 4 m
80-372-00-04	1	Bande auto-adhésive, 90 cm	- Nastro tessile auto-adesivo, 90 cm
80-505-00-04	1*	Tampon de nettoyage pour électrodes, emballage stérile	- Tampone di pulizia per elettrodi, imballaggio sterile
80-511-04-04	1	Electrode lancette, coudée	- Elettrodo a lancetta, angolato
80-515-04-04	1	Electrode couteau	- Elettrodo a bisturi
80-520-04-04	1	Electrode aiguille	- Elettrodo ad ago
80-562-04-04	1	Electrode boule, Ø 4 mm	- Elettrodo a sfera, Ø 4 mm

\* UC = 100 pièces

\* UV = 100 pezzi

Zubehörsätze für Kleingeräte  
 Accessory sets for minor electrosurgical units  
 Juegos de accesorios para aparatos pequeños  
 Jeux d'accessoires pour petits appareils  
 Serie di accessori per apparecchi piccoli

80-150-00-04		Satz bipolares Zubehör für ME 81/ME 82/Minicutter/ ME 102	Accessory set bipolar for ME 81/ME 82/Minicutter/ ME 102	Juego de accesorios bipolar para ME 81/ME 82/Minicutter/ ME 102
80-287-53-04	1	Anschlusskabel für bipolare Pinzetten	- Connection cable for bipolar forceps	- Cable de conexión para pinzas bipolares
80-924-16-04	1	Bipolare Pinzette, gerade, stumpf, 16 cm/6 1/4"	- Bipolar forceps, straight, blunt, 16 cm/6 1/4"	- Pinza bipolar, recta, roma, 16 cm/6 1/4"
80-945-20-04	1	Bipolare Pinzette, bajonettförmig, stumpf, 20 cm/8"	- Bipolar forceps, bayonet-shaped, blunt, 20 cm/8"	- Pinza bipolar, en forma bayoneta, roma, 20 cm/8"
80-925-16-04	1	Bipolare Pinzette, abgewinkelt, stumpf, 16 cm/6 1/4"	- Bipolar forceps, angled, blunt, 16 cm/6 1/4"	- Pinza bipolar, acodada, roma, 16 cm/6 1/4"
80-925-20-04	1	Bipolare Pinzette, abgewinkelt, stumpf, 20 cm/8"	- Bipolar forceps, angled, blunt, 20 cm/8"	- Pinza bipolar, acodada, roma, 20 cm/8"
80-924-20-04	1	Bipolare Pinzette, gerade, stumpf, 20 cm/8"	- Bipolar forceps, straight, blunt, 20 cm/8"	- Pinza bipolar, recta, roma, 20 cm/8"

80-150-01-04		Satz bipolares Zubehör mit NON-STICK <b>red</b> -Pinzetten für ME 81/ME 82/Minicutter/ ME 102	Set bipolar accessories with NON-STICK <b>red</b> forceps for ME 81/ME 82/Minicutter/ ME 102	Juego de accesorios bipolar con pinzas bipolares NON-STICK <b>red</b> ME 81/ME 82/Minicutter/ ME 102
80-287-53-04	1	Anschlusskabel für bipolare Pinzetten	- Connection cable for bipolar forceps	- Cable de conexión para pinzas bipolares
80-986-17-04	1	Bipolare Pinzette, NON-STICK <b>red</b> , gerade, stumpf, 16 cm/6 1/4"	- Bipolar forceps, NON-STICK <b>red</b> , straight, blunt, 16 cm/6 1/4"	- Pinza bipolar, NON-STICK <b>red</b> , recta, roma, 16 cm/6 1/4"
80-992-20-04	1	Bipolare Pinzette, NON-STICK <b>red</b> , bajonettförmig, stumpf, 20 cm/8"	- Bipolar forceps, NON-STICK <b>red</b> , bayonet-shaped, blunt, 20 cm/8"	- Pinza bipolar, NON-STICK <b>red</b> , en forma bayoneta, roma, 20 cm/8"
80-987-17-04	1	Bipolare Pinzette, NON-STICK <b>red</b> , abgewinkelt, stumpf, 16 cm/6 1/4"	- Bipolar forceps, NON-STICK <b>red</b> , angled, blunt, 16 cm/6 1/4"	- Pinza bipolar, NON-STICK <b>red</b> , acodada, roma, 16 cm/6 1/4"
80-987-20-04	1	Bipolare Pinzette, NON-STICK <b>red</b> , abgewinkelt, stumpf, 20 cm/8"	- Bipolar forceps, NON-STICK <b>red</b> , angled, blunt, 20 cm/8"	- Pinza bipolar, NON-STICK <b>red</b> , acodada, roma, 20 cm/8"
80-986-20-04	1	Bipolare Pinzette, NON-STICK <b>red</b> , gerade, stumpf, 20 cm/8"	- Bipolar forceps, NON-STICK <b>red</b> , straight, blunt, 20 cm/8"	- Pinza bipolar, NON-STICK <b>red</b> , recta, roma, 20 cm/8"



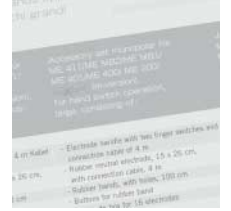

80-150-00-04		Lot d'accessoires bipolaire pour ME 81/ME 82/Minicutter/ ME 102	Serie di accessori bipolare per ME 81/ME 82/Minicutter/ ME 102
80-287-53-04	1	Câble de raccordement pour pinces bipolaires	- Cavo di connessione per pinze bipolari
80-924-16-04	1	Pince bipolaire, droite, mousse, 16 cm/6 1/4"	- Pinza bipolare, retta, smussa, 16 cm/6 1/4"
80-945-20-04	1	Pince bipolaire, en forme baïonnette, mousse, 20 cm/8"	- Pinza bipolare, a forma baionetta, smussa, 20 cm/8"
80-925-16-04	1	Pince bipolaire, coudée, mousse, 16 cm/6 1/4"	- Pinza bipolare, angolata, smussa, 16 cm/6 1/4"
80-925-20-04	1	Pince bipolaire, coudée, mousse, 20 cm/8"	- Pinza bipolare, angolata, smussa, 20 cm/8"
80-924-20-04	1	Pince bipolaire, droite, mousse, 20 cm/8"	- Pinza bipolare, retta, smussa, 20 cm/8"

80-150-01-04		Lot d'accessoires bipolaire avec pinces bipolaires NON-STICK red pour ME 81/ME 82/Minicutter/ ME 102	Set bipolar accessories with NON-STICK red forceps for ME 81/ME 82/Minicutter/ ME 102
80-287-53-04	1	Câble de raccordement pour pinces bipolaires	- Connection cable for bipolar forceps
80-986-17-04	1	Pince bipolaire, NON-STICK red, droite, mousse, 16 cm/6 1/4"	- Bipolar forceps, NON-STICK red, straight, blunt, 16 cm/6 1/4"
80-992-20-04	1	Pince bipolaire, NON-STICK red, en forme baïonnette, mousse, 20 cm/8"	- Bipolar forceps, NON-STICK red, bayonet-shaped, blunt, 20 cm/8"
80-987-17-04	1	Pince bipolaire, NON-STICK red, coudée, mousse, 16 cm/6 1/4"	- Bipolar forceps, NON-STICK red, angled, blunt, 16 cm/6 1/4"
80-987-20-04	1	Pince bipolaire, NON-STICK red, coudée, mousse, 20 cm/8"	- Bipolar forceps, NON-STICK red, angled, blunt, 20 cm/8"
80-986-20-04	1	Pince bipolaire, NON-STICK red, droite, mousse, 20 cm/8"	- Bipolar forceps, NON-STICK red, straight, blunt, 20 cm/8"



Nummern-Index  
 Index of order numbers  
 Índice de números de referencia  
 Index numérique des références de commande  
 Elenco dei codici

08-024-00-23 .....	72
08-024-00-28 .....	72
08-024-00-29 .....	72
08-024-00-30 .....	72
08-024-00-31 .....	72
08-025-00-23 .....	74
08-168-00-02 .....	76
08-168-00-03 .....	76
08-168-00-20 .....	76
80-006-02 .....	81
80-006-03 .....	81

80-181-16 .....	87, 92
80-181-17 .....	110
80-181-18 .....	110
80-181-19 .....	110
80-181-20 .....	110
80-181-22 .....	89, 94
80-181-23 .....	89, 94
80-181-24 .....	89, 94
80-181-25 .....	89
80-181-26 .....	89
80-181-27 .....	89
80-181-28 .....	89

80-289-40 .....	66
80-294-40 .....	38, 94
80-294-43 .....	106, 10
80-294-44 .....	38, 10
80-310-04 .....	1
80-332-03 .....	36,
80-342-03 .....	
80-342-06 .....	
80-344-02 .....	
80-344-06 .....	38
80-344-07 .....	10

NUMMERN-INDEX  
 INDEX OF ORDER NUMBERS  
 INDICE DE NUMEROS DE REFERENCIA  
 INDEX NUMERIQUE DES REFERENCES DE COMMANDE  
 ELENCO DEI CODICI

185-187

**08**

08-003-00-50 .....101  
 08-008-00-03 .....140  
 08-008-00-04 .....140  
 08-008-00-05 .....140  
 08-008-00-06 .....140  
 08-008-00-08 .....140  
 08-008-00-14 .....140  
 08-022-00-19 .....140  
 08-022-00-21 .....140  
 08-024-00-23 .....152  
 08-024-00-28 .....152  
 08-024-00-29 .....152  
 08-024-00-30 .....152  
 08-024-00-31 .....152  
 08-024-00-32 .....152  
 08-024-00-41 .....152  
 08-025-00-23 .....158  
 08-156-00-11 .....158  
 08-474-00-10 .....132, 133

**55**

55-804-25-01 .....60, 61  
 55-804-42-01 .....60, 61  
 55-805-28-01 .....60, 61  
 55-805-45-01 .....60, 61  
 55-806-02-04 .....60, 61  
 55-806-07-04 .....60, 61

**76**

76-100-60-04 .....128, 129

**79**

79-225-02-04 .....128, 129  
 79-225-03-04 .....128, 129  
 79-225-06-04 .....128, 129  
 79-225-07-04 .....128, 129  
 79-225-08-04 .....128, 129  
 79-225-09-04 .....128, 129  
 79-225-10-04 .....128, 129  
 79-225-11-04 .....128, 129

**80**

80-006-02-04 .....137  
 80-008-03-04 .....137  
 80-010-02-04 .....137  
 80-040-08-04 .....137  
 80-040-11-04 .....137  
 80-040-12-04 .....137  
 80-041-01-04 .....137  
 80-042-00-04 .....120, 121, 136  
 80-042-02-04 .....136  
 80-042-04-04 .....136  
 80-042-10-04 .....170  
 80-042-11-04 .....172, 173  
 80-042-12-04 .....174, 175  
 80-042-20-04 .....170  
 80-042-21-04 .....172, 173  
 80-042-22-04 .....174, 175  
 80-042-40-04 .....170  
 80-042-41-04 .....172, 173  
 80-042-42-04 .....174, 175  
 80-044-00-04 .....120, 121, 136  
 80-047-00-04 .....120, 121, 154, 157,  
 .....172, 173, 174, 175  
 80-060-00-04 .....126, 127  
 80-060-00-10 .....126, 127  
 80-060-01-04 .....128, 129  
 80-060-02-04 .....130  
 80-060-03-04 .....130  
 80-060-05-04 .....128, 129  
 80-060-06-04 .....128, 129  
 80-061-00-04 .....126, 127  
 80-061-00-10 .....126, 127  
 80-065-00-04 .....132, 133  
 80-065-01-04 .....132, 133  
 80-065-02-04 .....132, 133  
 80-070-00-04 .....158  
 80-070-01-04 .....158  
 80-070-02-04 .....159  
 80-070-03-04 .....159  
 80-070-04-04 .....159  
 80-070-05-04 .....158  
 80-081-00-04 .....120, 121, 136  
 80-091-01-04 .....128, 129  
 80-091-02-04 .....128, 129

80-093-00-04 .....98, 136  
 80-093-01-04 .....136  
 80-093-02-04 .....136  
 80-103-00-04 .....140  
 80-105-00-04 .....138  
 80-105-01-04 .....138  
 80-105-02-04 .....138  
 80-106-01-04 .....176, 177  
 80-107-00-04 .....176, 177  
 80-108-00-04 .....180, 181  
 80-108-01-04 .....180, 181  
 80-108-02-04 .....180, 181  
 80-108-03-04 .....178, 179  
 80-108-04-04 .....178, 179  
 80-108-05-04 .....178, 179  
 80-120-50-04 .....104  
 80-120-51-04 .....104  
 80-122-50-04 .....104  
 80-122-60-04 .....104  
 80-140-00-04 .....162, 163  
 80-140-01-04 .....164, 165  
 80-140-02-04 .....166, 167  
 80-150-00-04 .....162, 163, 182, 183  
 80-150-01-04 .....164, 165, 182, 183  
 80-160-00-04 .....166, 167  
 80-160-01-04 .....166, 167  
 80-160-02-04 .....168, 169  
 80-181-02-04 .....12, 110, 120, 121,  
 .....122, 123, 172, 173  
 80-181-05-04 .....111  
 80-181-07-04 .....113  
 80-181-08-04 .....113  
 80-181-10-04 .....111, 120, 121,  
 .....172, 173  
 80-181-11-04 .....111, 120, 121  
 80-181-12-04 .....112, 122, 123  
 80-181-13-04 .....113, 120, 121,  
 .....172, 173  
 80-181-14-04 .....113, 120, 121  
 80-181-15-04 .....113, 120, 121,  
 .....172, 173  
 80-181-16-04 .....113, 120, 121  
 80-181-17-04 .....118  
 80-181-23-04 .....116, 122, 123,  
 .....174, 175  
 80-181-24-04 .....116, 122, 123,  
 .....174, 175  
 80-181-25-04 .....116, 122, 123,  
 .....174, 175  
 80-181-26-04 .....116  
 80-181-27-04 .....116  
 80-181-28-04 .....116  
 80-181-29-04 .....116  
 80-181-30-04 .....114, 122, 123,  
 .....174, 175  
 80-181-31-04 .....114  
 80-181-32-04 .....116  
 80-181-40-04 .....117  
 80-181-41-04 .....117  
 80-181-42-04 .....117  
 80-181-43-04 .....117  
 80-181-44-04 .....117  
 80-181-50-04 .....119, 120, 121,  
 .....122, 123  
 80-181-51-04 .....119, 120, 121,  
 .....122, 123, 132, 133  
 80-181-52-04 .....119, 120, 121,  
 .....172, 173, 174, 175  
 80-181-53-04 .....119, 120, 121,  
 .....172, 173, 174, 175  
 80-181-54-04 .....119, 120, 121  
 80-181-55-04 .....119, 120, 121,  
 .....172, 173, 174, 175  
 80-181-56-04 .....119, 120, 121  
 80-181-57-04 .....119, 120, 121  
 80-181-60-04 .....112  
 80-181-62-04 .....112  
 80-181-90-04 .....110, 114, 118,  
 .....122, 123  
 80-210-02-04 .....12, 168, 169  
 80-210-03-04 .....9  
 80-210-12-04 .....7, 12, 130, 170, 171  
 80-210-16-04 .....9, 12  
 80-213-01-04 .....11, 93  
 80-214-00-04 .....11  
 80-214-01-04 .....11  
 80-214-10-04 .....10, 12, 176, 177

80-214-11-04 .....10, 12, 176, 177  
 80-217-01-04 .....10, 12, 31, 132, 133,  
 .....178, 179, 180, 181  
 80-217-02-04 .....6, 12, 162, 163,  
 .....166, 167, 180, 181  
 80-217-03-04 .....132, 133  
 80-217-12-04 .....6, 12, 170, 171  
 80-217-32-04 .....8, 170, 171  
 80-219-02-04 .....6, 12  
 80-219-12-04 .....6, 12  
 80-219-42-04 .....7  
 80-220-00-04 .....6, 12, 132, 133,  
 .....164, 165, 178, 179,  
 .....180, 181  
 80-220-30-04 .....8  
 80-220-40-04 .....8  
 80-221-02-04 .....9, 12, 166, 167  
 80-225-00-04 .....7  
 80-225-01-04 .....7  
 80-225-02-04 .....7  
 80-250-00-04 .....100  
 80-251-00-04 .....99  
 80-260-50-04 .....155, 170, 171,  
 .....172, 173, 174, 175  
 80-280-30-04 .....11, 93, 104  
 80-285-40-04 .....34, 92, 105  
 80-285-50-04 .....34, 92, 105  
 80-285-51-04 .....95  
 80-285-55-04 .....34, 93, 105  
 80-286-30-04 .....44, 46, 51, 59, 67,  
 .....74, 76, 96, 106  
 80-286-40-04 .....51, 59, 67, 106  
 80-286-50-04 .....44, 46, 51, 74,  
 .....76, 96, 106  
 80-286-60-04 .....96, 106  
 80-286-80-04 .....107  
 80-286-94-04 .....94, 105  
 80-286-95-04 .....94, 105  
 80-286-96-04 .....94, 105  
 80-287-33-04 .....44, 46, 51, 59,  
 .....67, 74, 76, 95, 106,  
 .....170, 171, 172, 173,  
 .....174, 175  
 80-287-42-04 .....95, 106  
 80-287-44-04 .....96, 106  
 80-287-53-04 .....44, 46, 51, 59, 67,  
 .....74, 76, 95, 106,  
 .....162, 163, 164, 165,  
 .....182, 183  
 80-287-60-04 .....95, 106  
 80-287-70-04 .....96, 106  
 80-287-72-04 .....45, 47, 51, 59, 67,  
 .....75, 77, 96, 106  
 80-287-80-04 .....107  
 80-287-89-04 .....44, 46, 51, 59, 67,  
 .....74, 76, 97, 106, 170,  
 .....171, 172, 173,  
 .....174, 175  
 80-287-90-04 .....44, 46, 51, 59, 67,  
 .....74, 76, 97, 106  
 80-287-91-04 .....98, 107  
 80-287-93-04 .....98, 107  
 80-287-94-04 .....98, 107  
 80-287-95-04 .....98, 107  
 80-287-96-04 .....98, 107  
 80-288-53-04 .....95, 107  
 80-288-55-04 .....95, 107  
 80-288-57-04 .....96, 97, 107  
 80-288-60-04 .....97  
 80-288-70-04 .....71  
 80-288-72-04 .....71  
 80-288-80-04 .....97, 107  
 80-289-40-04 .....92, 104, 117,  
 .....174, 175  
 80-289-41-04 .....93, 104, 117  
 80-289-42-04 .....92, 104  
 80-290-40-04 .....93, 104  
 80-291-40-04 .....51, 59, 67, 106  
 80-293-40-04 .....51, 59, 67, 106  
 80-294-40-04 .....41, 122, 123, 166,  
 .....167, 170, 171, 172,  
 .....173, 174, 175  
 80-294-43-04 .....41  
 80-294-44-04 .....41, 132, 133,  
 .....166, 167, 168, 169,  
 .....170, 171, 172, 173,  
 .....174, 175

80-310-04-04 .....40, 176, 177  
 80-332-03-04 .....38, 178, 179,  
 .....180, 181  
 80-342-03-04 .....38, 162, 163,  
 .....164, 165, 166, 167  
 80-342-04-04 .....38  
 80-342-05-04 .....38  
 80-342-06-04 .....39  
 80-344-09-04 .....41, 132, 133,  
 .....166, 167, 168, 169,  
 .....170, 171, 172, 173,  
 .....174, 175  
 80-344-11-04 .....42  
 80-344-12-04 .....42  
 80-370-50-04 .....39, 40, 178,  
 .....179, 180, 181  
 80-371-00-04 .....39, 40, 162,  
 .....163, 164, 165  
 80-371-01-04 .....40, 162, 163,  
 .....164, 165, 178,  
 .....179, 180, 181  
 80-371-02-04 .....39  
 80-372-00-04 .....40, 166, 167,  
 .....178, 179, 180, 181  
 80-408-00-01 .....33  
 80-416-00-01 .....33, 162, 163,  
 .....164, 165  
 80-444-08-01 .....33, 176, 177  
 80-460-04-04 .....32  
 80-461-01-04 .....26, 176, 177  
 80-461-02-04 .....26, 176, 177  
 80-461-03-04 .....26  
 80-461-04-04 .....27  
 80-461-06-04 .....27  
 80-461-07-04 .....27  
 80-461-11-04 .....27  
 80-461-12-04 .....27, 176, 177  
 80-461-13-04 .....27  
 80-461-14-04 .....28, 176, 177  
 80-461-15-04 .....28, 176, 177  
 80-461-16-04 .....28  
 80-461-17-04 .....28  
 80-461-18-04 .....28  
 80-461-19-04 .....28  
 80-461-20-04 .....28  
 80-461-21-04 .....28  
 80-461-22-04 .....29  
 80-461-23-04 .....29  
 80-461-24-04 .....29  
 80-461-31-04 .....29, 176, 177  
 80-461-32-04 .....29  
 80-461-33-04 .....30  
 80-461-34-04 .....30, 176, 177  
 80-461-35-04 .....30  
 80-461-36-04 .....30  
 80-461-37-04 .....30  
 80-462-01-04 .....26  
 80-462-02-04 .....26  
 80-462-11-04 .....27  
 80-462-12-04 .....27  
 80-462-13-04 .....27  
 80-463-01-04 .....26  
 80-464-02-04 .....26  
 80-464-38-04 .....27  
 80-466-01-04 .....26  
 80-505-00-04 .....15, 162, 163, 164,  
 .....165, 166, 167, 168,  
 .....169, 170, 171, 178,  
 .....179, 180, 181  
 80-510-04-04 .....17, 162, 163, 164,  
 .....165, 170, 171, 178,  
 .....179, 180, 181  
 80-510-06-04 .....14, 15  
 80-510-08-04 .....16, 168, 169  
 80-510-12-04 .....20  
 80-511-04-04 .....17, 162, 163, 164,  
 .....165, 166, 167, 170, 171,  
 .....178, 179, 180, 181  
 80-511-06-04 .....14  
 80-515-04-04 .....17, 162, 163, 164,  
 .....165, 166, 167, 170, 171,  
 .....178, 179, 180, 181  
 80-515-06-04 .....14, 15  
 80-515-08-04 .....16, 168, 169  
 80-515-12-04 .....20  
 80-515-14-04 .....21  
 80-515-16-04 .....21

Nummern-Index  
 Index of order numbers  
 Indice de números de referencia  
 Index numérique des références de commande  
 Elenco dei codici

80-181-16	87, 92
80-181-17	110
80-181-18	110
80-181-19	110
80-181-20	110
80-181-22	89, 94
80-181-23	89, 94
80-181-24	89, 94
80-181-25	89
80-181-26	89

80-516-04-04	17
80-516-06-04	14
80-519-04-04	17
80-520-04-04	17, 162, 163, 164, 165, 166, 167, 178, 179, 180, 181
80-520-06-04	14, 15
80-520-08-04	16, 168, 169
80-520-09-04	16
80-520-10-04	16
80-521-02-04	14
80-521-04-04	14
80-522-04-04	14
80-525-04-04	31, 162, 163, 164, 165, 178, 179, 180, 181
80-530-01-04	31
80-530-02-04	31
80-530-03-04	30
80-530-04-04	30
80-530-05-04	31
80-530-06-04	30
80-531-00-04	32
80-532-00-04	32, 162, 163, 164, 165, 178, 179, 180, 181
80-533-00-04	32
80-533-01-04	32
80-534-06-04	22
80-534-12-04	22
80-540-04-04	17, 162, 163, 164, 165, 178, 179, 180, 181
80-540-12-04	21
80-542-04-04	17, 162, 163, 164, 165, 178, 179, 180, 181
80-542-06-04	15
80-542-08-04	16, 168, 169
80-542-12-04	21
80-545-04-04	17
80-550-04-04	17, 162, 163, 164, 165
80-550-06-04	15
80-552-04-04	17, 162, 163, 164, 165
80-560-04-04	17, 162, 163, 164, 165, 170, 171, 178, 179, 180, 181
80-560-06-04	15
80-562-04-04	17, 162, 163, 164, 165, 166, 167, 178, 179, 180, 181
80-562-06-04	15
80-562-08-04	16, 168, 169
80-563-04-04	17, 162, 163, 164, 165
80-563-05-04	31
80-565-01-04	132, 133
80-565-02-04	132, 133
80-565-03-04	132, 133
80-570-00-04	45, 47
80-570-04-04	17, 162, 163, 164, 165
80-570-18-04	44
80-570-21-04	44
80-570-23-04	44, 170, 171, 172, 173
80-570-28-04	44
80-571-18-04	45
80-571-21-04	45
80-571-23-04	45
80-571-28-04	45
80-572-04-04	17
80-572-13-04	46
80-572-14-04	46
80-572-17-04	46
80-574-04-04	17
80-580-06-04	15
80-610-10-04	24
80-612-10-04	24
80-630-01-04	84, 85
80-630-03-04	84, 85
80-630-08-04	84, 85, 86, 87
80-630-09-04	84, 85, 86, 87
80-630-12-04	84, 85
80-630-15-04	84, 85, 86, 87
80-630-17-04	84, 85, 86, 87
80-630-18-04	84, 85, 86, 87
80-630-30-04	86, 87
80-630-31-04	86, 87

80-630-32-04	86, 87
80-630-33-04	86, 87
80-630-34-04	86, 87
80-630-35-04	86, 87
80-630-41-04	84, 85
80-630-42-04	86, 87
80-630-43-04	86, 87
80-630-45-04	84, 85, 86, 87
80-630-50-04	88, 89
80-630-51-04	88, 89
80-630-52-04	88, 89
80-630-53-04	88, 89
80-630-54-04	88, 89
80-630-55-04	88, 89
80-630-56-04	88, 89
80-630-57-04	88, 89
80-630-58-04	82, 83, 88, 89
80-630-59-04	88, 89
80-630-83-04	88, 89
80-630-90-04	88, 89
80-630-91-04	88, 89
80-630-92-04	88, 89
80-632-00-04	82, 83
80-632-01-04	82, 83
80-632-18-04	82, 83
80-650-00-04	70
80-651-00-04	70
80-652-00-04	70
80-652-01-04	70
80-674-12-04	22
80-674-13-04	22
80-675-13-04	20
80-676-13-04	22
80-677-12-04	20
80-678-05-04	23
80-678-10-04	23
80-678-11-04	23
80-680-12-04	18
80-681-12-04	18
80-682-12-04	18
80-683-12-04	18
80-684-12-04	19
80-685-12-04	19
80-686-12-04	19
80-690-12-04	25
80-691-12-04	25
80-692-12-04	25
80-693-12-04	25
80-694-12-04	25
80-695-12-04	25
80-790-00-04	102
80-790-01-04	102
80-790-02-04	103
80-793-02-04	100
80-794-02-04	101
80-795-02-04	100
80-795-03-04	99
80-795-04-04	99
80-795-05-04	99
80-796-02-04	100
80-796-03-04	101
80-797-00-04	147
80-797-01-04	147
80-797-02-04	101
80-800-00-04	103
80-811-04-04	142, 146, 147, 148, 149
80-811-10-04	143, 148
80-811-30-04	122, 123, 145, 147, 149, 166, 167, 168, 169, 170, 171, 172, 173
80-811-32-04	145, 147, 149
80-811-50-04	128, 129, 132, 133, 142, 146, 147, 148, 149, 170, 171, 172, 173, 174, 175, 178, 179
80-812-10-04	142, 148, 176, 177
80-821-02-04	122, 123, 144, 147, 149, 156, 164, 165
80-821-02-04	156
80-821-03-04	144, 145, 147, 149
80-821-04-04	146, 149
80-821-05-04	147, 149
80-823-02-04	143, 148, 180, 181
80-824-01-04	143, 148
80-825-30-04	147, 149

80-900-18-03	34
80-900-21-03	34
80-900-25-03	34
80-902-18-03	34
80-902-21-03	34
80-902-25-03	34
80-910-07-04	48
80-910-12-04	48
80-910-16-04	48
80-910-18-04	48
80-910-20-04	48
80-910-22-04	48
80-911-07-04	49
80-911-12-04	49
80-911-16-04	49
80-911-18-04	49
80-911-20-04	49
80-924-12-04	48
80-924-16-04	48, 162, 163, 170, 171, 172, 173, 174, 175, 182, 183
80-924-18-04	48
80-924-20-04	48, 162, 163, 182, 183
80-924-22-04	48
80-924-24-04	48
80-924-26-04	48
80-924-30-04	48
80-925-12-04	49
80-925-16-04	49, 162, 163, 182, 183
80-925-18-04	49
80-925-20-04	49, 162, 163, 182, 183
80-925-22-04	49
80-931-16-04	50
80-931-18-04	50
80-931-20-04	50
80-931-24-04	50
80-934-12-04	48
80-934-16-04	48
80-934-18-04	48
80-934-20-04	48
80-934-22-04	48
80-934-24-04	48
80-934-26-04	48
80-934-30-04	48
80-935-16-04	49
80-935-18-04	49
80-935-20-04	49
80-935-22-04	49
80-935-24-04	49
80-945-16-04	50
80-945-18-04	50
80-945-20-04	50, 162, 163, 182, 183
80-945-24-04	50
80-948-18-04	50
80-948-20-04	50
80-948-24-04	50
80-948-30-04	50
80-950-20-04	51
80-951-20-04	51
80-971-16-04	74
80-971-18-04	74
80-971-23-04	74, 170, 171, 172, 173
80-971-28-04	75
80-973-23-04	76
80-973-24-04	77
80-974-23-04	76
80-975-16-04	78
80-975-18-04	78
80-975-23-04	78
80-975-28-04	79
80-976-23-04	80
80-977-23-04	81
80-978-23-04	80
80-981-01-04	64
80-981-02-04	64
80-981-03-04	64
80-981-04-04	64
80-981-05-04	65
80-981-06-04	65
80-981-07-04	64
80-982-12-04	54
80-982-17-04	54

80-982-20-04	54
80-982-23-04	54
80-983-12-04	55
80-983-17-04	55
80-984-12-04	54
80-984-17-04	54
80-984-20-04	54
80-985-12-04	55
80-985-17-04	55
80-985-20-04	55
80-986-12-04	54
80-986-17-04	54, 164, 165, 182, 183
80-986-20-04	54, 164, 165, 182, 183
80-986-23-04	54
80-987-12-04	55
80-987-17-04	55, 164, 165, 182, 183
80-987-20-04	55, 164, 165, 182, 183
80-987-23-04	55
80-988-17-04	54
80-988-20-04	54
80-988-23-04	54
80-988-30-04	54
80-989-17-04	55
80-989-20-04	55
80-989-23-04	55
80-989-25-04	55
80-989-28-04	55
80-989-30-04	55
80-990-17-04	56
80-990-20-04	56
80-990-23-04	56
80-990-25-04	56
80-991-17-04	56
80-991-20-04	56
80-991-23-04	56
80-991-25-04	56
80-992-17-04	56
80-992-20-04	56, 164, 165, 182, 183
80-992-23-04	56
80-992-25-04	56
80-993-17-04	56
80-993-20-04	56
80-993-23-04	56
80-993-25-04	56
80-994-20-04	57
80-994-23-04	57
80-994-25-04	57
80-995-20-04	57
80-995-23-04	57
80-995-25-04	57
80-996-23-04	57
80-996-25-04	57
80-997-23-04	57
80-997-25-04	57
80-998-23-04	58
80-999-23-04	58
80-999-24-04	58

**83**

83-120-50-04	35, 92
83-120-51-04	35, 93
83-122-50-04	92
83-122-60-04	92
83-124-50-04	93, 104
83-124-52-04	34, 93, 105
83-520-39-04	35
83-585-00-04	69
83-585-03-04	68
83-585-05-04	68
83-585-06-04	68
83-585-07-04	68

**94**

94-179-58-04	119, 172, 173, 174, 175
94-179-59-04	119
94-810-28-04	99



Der respektvolle Umgang mit Menschen, Gesellschaft und Umwelt ist für uns selbstverständlich. Die große Mehrzahl unserer Produkte ist auf Wiederverwertbarkeit und jahrelange Nutzung ausgelegt. Dies schont Ressourcen und reduziert das Abfallvolumen. Bei unserer Produktion kommen umweltfreundliche und recyclebare Stoffe zum Einsatz; Energie- und Wasserverbrauch werden überwacht. In unserer größten Produktionsstätte sorgt eine Wärmerückgewinnungsanlage für einen effizienten Energiehaushalt. Diese und viele weitere Maßnahmen sind Zeichen unseres Umwelt-Engagements.

The respectful treatment of people, society and the environment has always been a matter of course to us. By design, most of our products can be recycled and used over many years, thus saving resources and reducing waste. Environmentally-friendly and recyclable materials are used also for our production processes, and energy and water consumption monitoring is a top priority as well. A case in point: our largest manufacturing site includes a heat recovery plant for efficient energy utilization. These and many other measures are clear evidence of our environmental commitment.

Para nosotros, el trato respetuoso de las personas, la sociedad y el medio ambiente se sobreentiende. La gran mayoría de nuestros productos está diseñado para ser utilizado durante años y, finalmente, reciclado. Esto ahorra recursos y reduce el volumen de residuos. En nuestra producción utilizamos materiales reciclables y de bajo impacto ambiental; el consumo de energía y agua es controlado. Un sistema de recuperación de calor proporciona un balance energético eficiente en nuestra mayor sede de producción. Estás y numerosas otras medidas implementadas simbolizan nuestro compromiso medioambiental.

Un comportement respectueux envers les hommes, la société et l'environnement sont pour nous une évidence. La grande majorité de nos produits sont conçus pour être recyclés et utilisés pendant de longues années. Cela ménage les ressources naturelles et réduit le volume des déchets. Dans notre production, nous utilisons des matières écologiques et recyclables; nous avons à l'oeil la consommation d'eau et d'énergie. Dans notre plus grand site de production, les installations de récupération de chaleur assurent un bilan énergétique équilibré. Cette mesure et de nombreuses autres sont le signe de notre engagement en faveur de l'environnement.

Per noi è più che ovvio assumere un atteggiamento rispettoso nei confronti delle persone, della società e dell'ambiente. La maggior parte dei nostri prodotti sono creati con lo scopo della riutilizzabilità e dell'uso pluriennale. Ne consegue un risparmio delle risorse e la riduzione del volume di rifiuti. La nostra produzione prevede l'impiego di materie ecocompatibili e riciclabili, controllando il consumo energetico e idrico. Nel nostro maggiore centro di produzione un impianto di recupero del calore provvede ad un bilancio energetico efficiente. Queste e molte altre misure sono prove del nostro impegno per l'ambiente.

Weitere Informationen entnehmen Sie bitte der separaten Broschüre.

For further information please refer to our separate product brochure.

Encontrará informaciones adicionales en el folleto individual.

Vous trouverez des informations supplémentaires dans la brochure.

Per ulteriori informazioni vedasi il prospetto separato.





## KLS Martin Group

**KLS Martin France SARL**  
68200 Mulhouse · France  
Tel. +33 3 89 51 3150  
france@klsmartin.com

**KLS Martin UK Ltd.**  
Reading RG1 3EU · UK  
Tel. +44 1189 000 570  
uk@klsmartin.com

**KLS Martin do Brasil Ltda.**  
CEP 04.531-011 São Paulo · Brazil  
Tel.: +55 11 3554 2299  
brazil@klsmartin.com

**Gebrüder Martin GmbH & Co. KG**  
Representative Office  
121471 Moscow · Russia  
Tel. +7 499 792-76-19  
russia@klsmartin.com

**Martin Italia S.r.l.**  
20864 Agrate Brianza (MB) · Italy  
Tel. +39 039 605 6731  
italia@klsmartin.com

**Nippon Martin K.K.**  
Osaka 541-0046 · Japan  
Tel. +81 6 62 28 90 75  
nippon@klsmartin.com

**KLS Martin Australia Pty Limited**  
Artarmon NSW 2064 · Australia  
Tel.: +61 2 9439 5316  
australia@klsmartin.com

**Gebrüder Martin GmbH & Co. KG**  
Representative Office  
201203 Shanghai · China  
Tel. +86 21 5820 6251  
china@klsmartin.com

**Martin Nederland/Marned B.V.**  
1271 AG Huizen · The Netherlands  
Tel. +31 35 523 45 38  
nederland@klsmartin.com

**KLS Martin L.P.**  
Jacksonville, FL 32246 · USA  
Tel. +1 904 641 77 46  
usa@klsmartin.com

**KLS Martin SE Asia Sdn. Bhd.**  
14100 Simpang Ampat,  
Penang · Malaysia  
Tel.: +604 505 7838  
malaysia@klsmartin.com

**Gebrüder Martin GmbH & Co. KG**  
Representative Office  
Dubai · United Arab Emirates  
Tel. +971 4 454 16 55  
middleeast@klsmartin.com

### **Gebrüder Martin GmbH & Co. KG**

#### **A company of the KLS Martin Group**

KLS Martin Platz 1 · 78532 Tuttlingen · Germany  
Postfach 60 · 78501 Tuttlingen · Germany  
Tel. +49 7461 706-0 · Fax +49 7461 706-193  
info@klsmartin.com · www.klsmartin.com

